



UPSHINE®



# Technical Application Guide for UP-SHINE LED Panel Light

UP-PL2X2-40W-E

UP-PL2X2-40W-E-D

# Introduction



Up-shine LED troffer adopts LM-80 SMD led chip, with UL&cUL, DLC approved for North America market. 1X4, 2X2, 2X4 sizes are available for various demand. Branded led driver with top quality component ensures long life time. 0-10V dimmable and non-dimmable version both provided.

The ultra slim profile fits seamlessly into any workplace. It is available in the following installation ways: embedded into ceiling, suspended with hanging wires.

- Up to 80% energy saving compared to standard CFL
- Long lifetime of 50,000 hours
- 0-10V dimmable
- 120° wide beam angle
- CCT: 2700K 3000K  
4000K 5000K
- No UV/IR light
- Environment friendly, without Mercury or any other hazardous substances

## Application notes

- IP40 for indoor use
- Professional electrician for installation only
- Switch off before installation
- Do not touch when in use
- Keep away from hot steam and corrosive gas

## Application Areas

Widely used for various commercial lighting and residential lighting applications, such as offices, shopping mall, hotel, restaurant, hospital, home lighting etc.



# Product Information

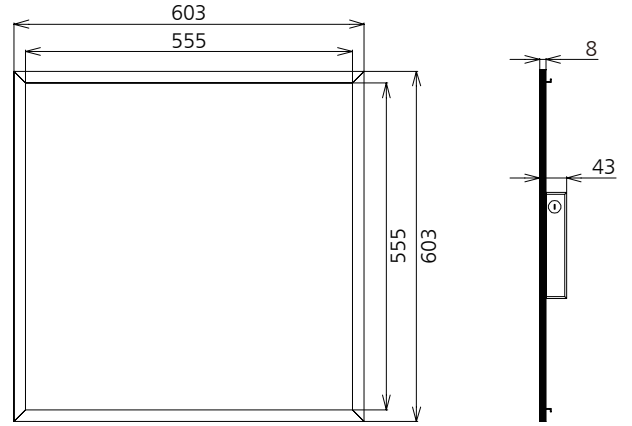

## Technical Specifications

Model	Voltage	Power	Power Factor	Lumen (±5%)	Beam angle	CCT	Lifespan	CRI	Dimmable	Dimension
UP-PL2X2-40W-E	AC100-277V	40W	≥0.9	3750	120°	2700K	50000h	≥80	No	603*603*8mm
				3800	120°	3000K				
				4000	120°	4000K				
				4050	120°	5000K				
UP-PL2X2-40W-E-D	AC100-277V	40W	≥0.9	3750	120°	2700K	50000h	≥80	Yes	603*603*8mm
				3800	120°	3000K				
				4000	120°	4000K				
				4050	120°	5000K				

## Driver data Sheet

Driver data	DIM	Non-dim
Input rated Voltage	AC100-277V	AC100-277V
Frequency	50/60Hz	50/60Hz
Input Voltage	AC90-305V	AC90-305V
Efficiency	≥85%	≥85%
Total load Wattage	40W±5%	40W±5%
Power Factor	≥0.9	≥0.9
Rated input current	≤0.5A	≤0.5A
Full load output Voltage	DC35-38V	DC35-38V
Rated output current	950mA	950mA
Output current range	950mA±5%	950mA±5%
Power tolerance	±5%	±5%
Current output tolerance	±5%	±5%
Dimming range	1%-100%	—
Dimmer	0V-10V dimmer	—
Short circuit protection	PASS	PASS
Over voltage protection	PASS	PASS
Over temperature protection	PASS	PASS
Withstand voltage	AC3750V	AC3750V

## Fixture Compatibility

Rated Wattage	With Ground	Ingress Protection	Operating Temp	Operating Humidity	Storage Temp
40W	Yes	Dry Location	-20°C~45°C	0~90%	-20°C~65°C

# Spectral Distribution

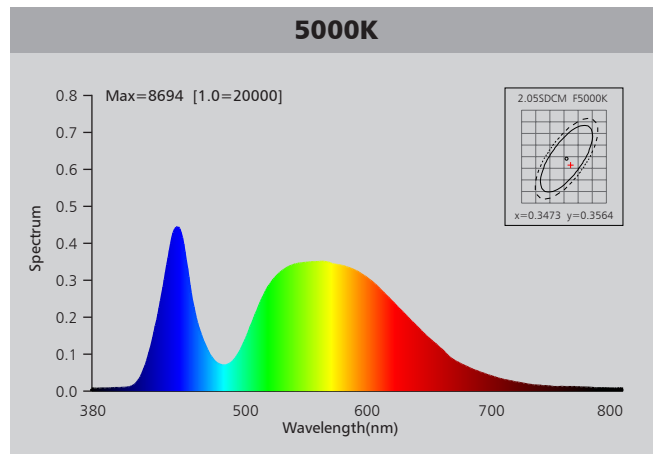
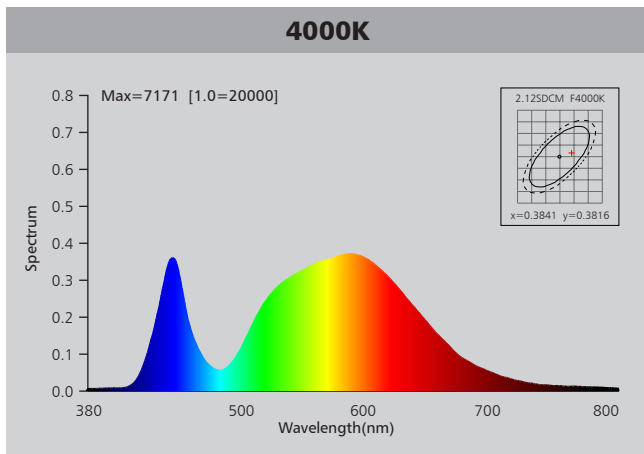
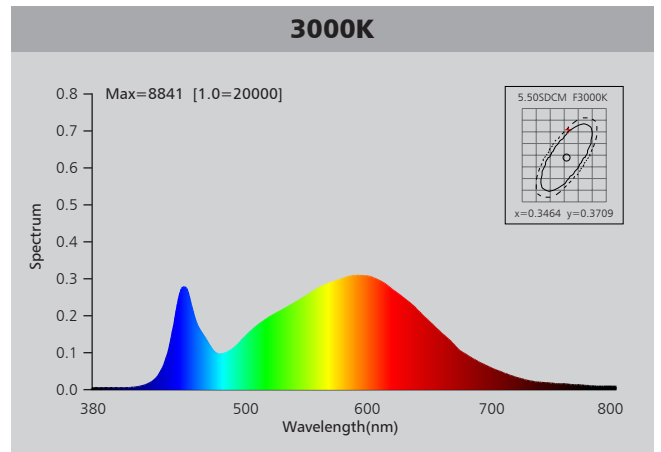
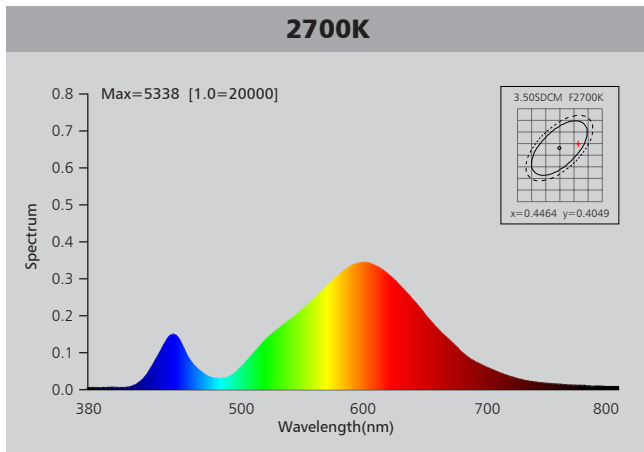

# Photometric Diagram

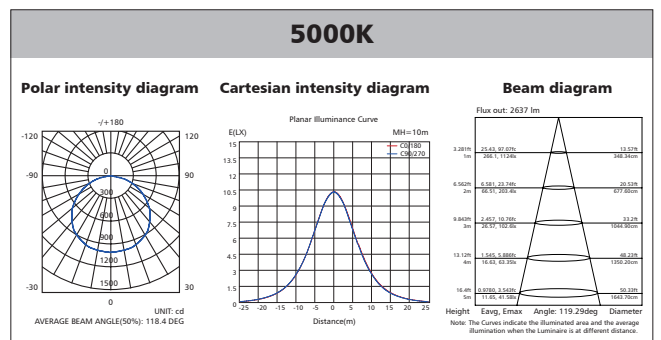
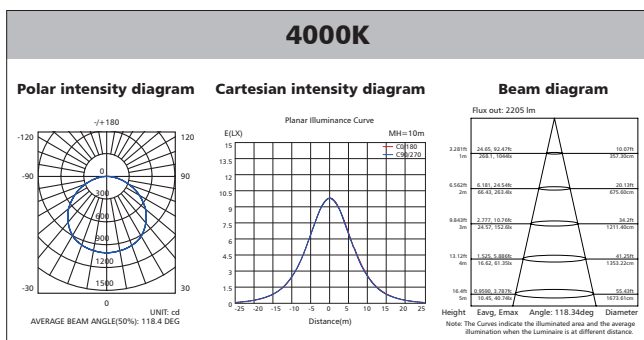
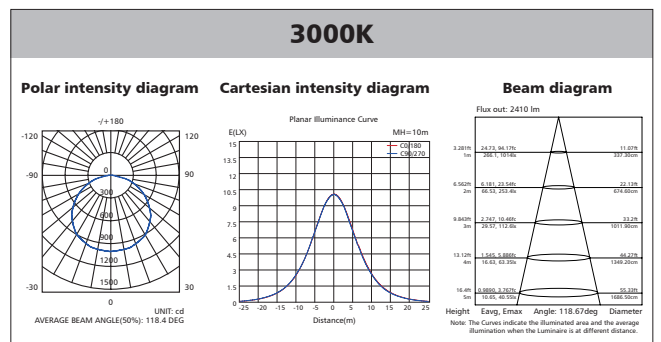
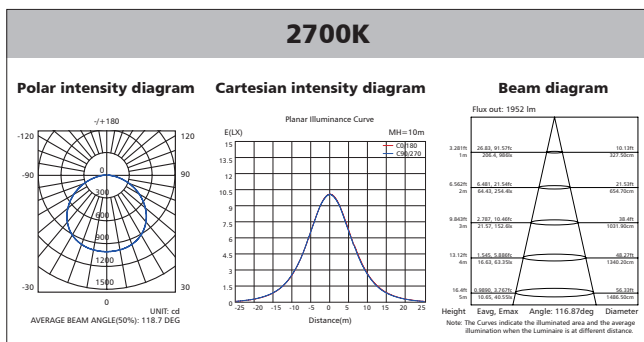

## Polar Diagram Comparison

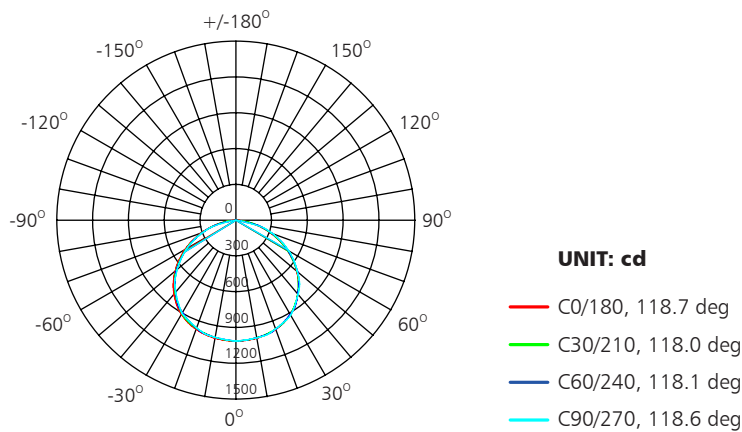

AVERAGE BEAM ANGLE (50%): 118.4DEG



## Driver lifetime & LED light decay rate

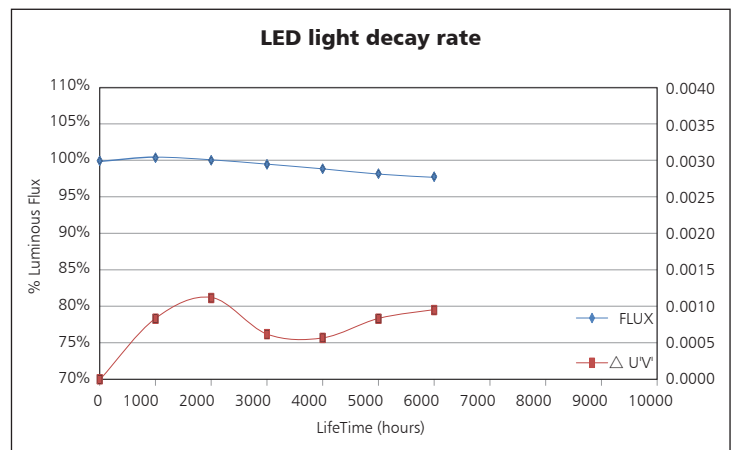
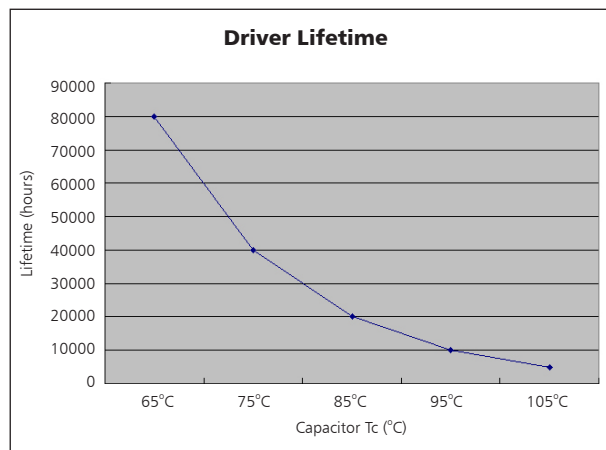

## Temperature

- The testing is operated at 25°C
- The lifetime of capacitor, minimum of 5,000 hours if operated at 105°C, will be doubled whenever the temperature drops 10°C
- The highest withstand temperature of IC, MOS could be 120°C
- The highest withstand temperature of LED junction temperature is 150°C

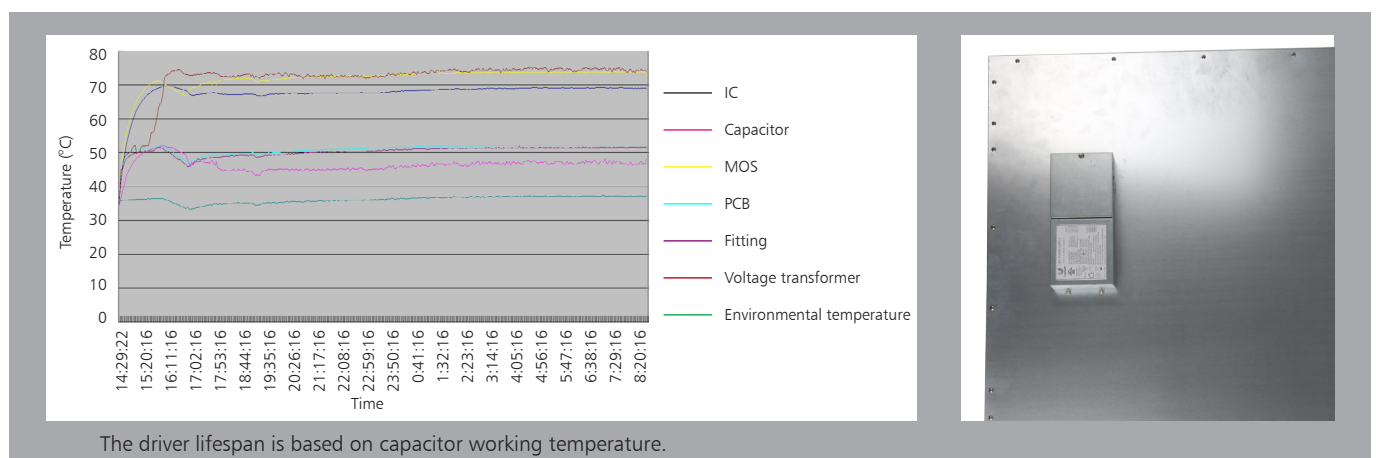

# Installation

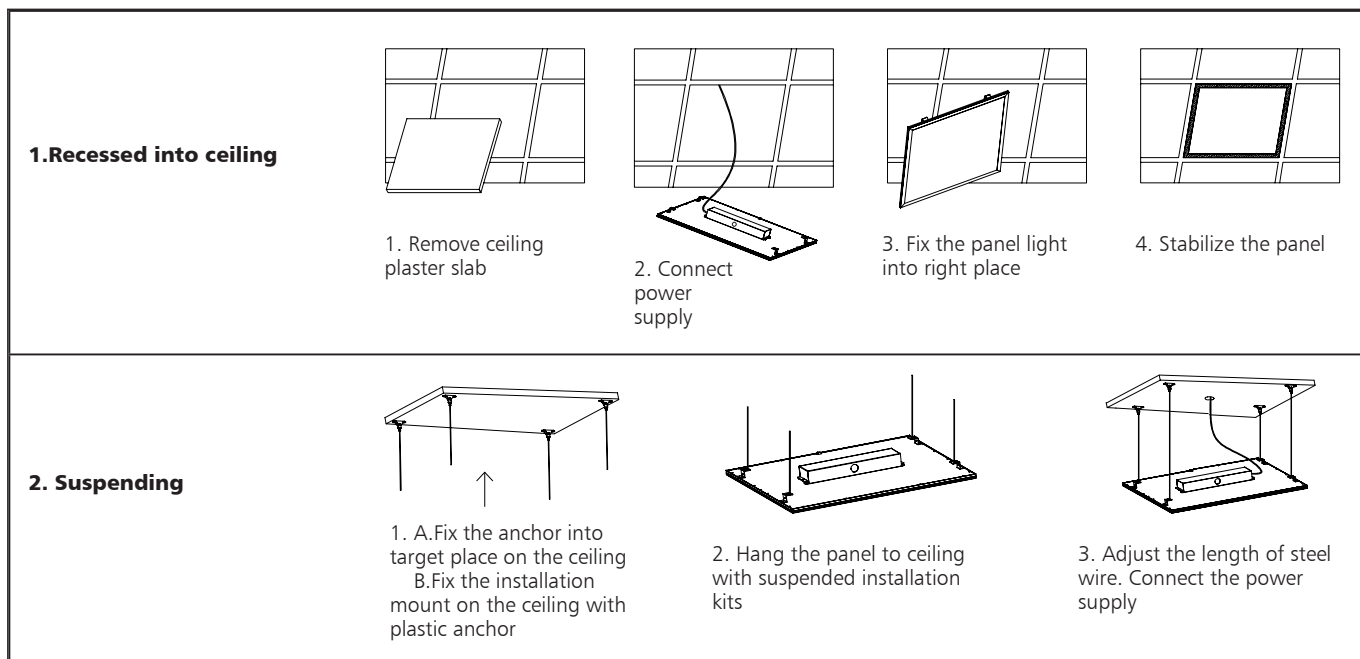

# Packaging Information

	SIZE(CM)	N.W/pc (KGS)	G.W.(KGS)	Q'TY(PCS)
Carton	67*21*67.5	3.1	15.5	4

	CTNS	Q'TY(PCS)	VOLUME(CBM)
20" standard container	290	1160	28
40" standard container	580	2320	56

