



Up-shine[®] Lighting



Technical Application
Guide for UP-SHINE
LED Downlight
UP-DL60-5&6-12W-D

Introduction

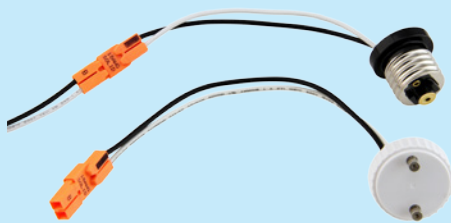

Up-shine DL60 downlight retrofit kit adopts high lumen LM80 SMD led chip, with efficiency of 75-80 LPW. UL cUL and Energy Star approved for North America. 4inch, 5inch and 6inch full sizes in E26 & GU24 adaptor for installation. Triac dim minimum to 8%. Compatible with Lutron dimmers

- Up to 70% energy saving compared to standard CFL
- Long lifetime of 36,000 hours
- Dimmable when using triac dimmer
- 100° wide beam angle
- CCT: 2700K 3000K
4000K 5000K
- No UV/IR light
- Environment friendly, without Mercury or any other hazardous substances

Application notes

- IP54 for indoor use only
- Professional electrician for installation only
- Switch off before installation
- Do not touch when in use
- Keep away from hot steam and corrosive gas

Application Areas

It is designed for general lighting applications in office, supermarket, shop, school, hotel, etc. It is also widely used for public areas, such as stairway, lobby, reception, corridors etc.

Certificate

RoHS **FC**

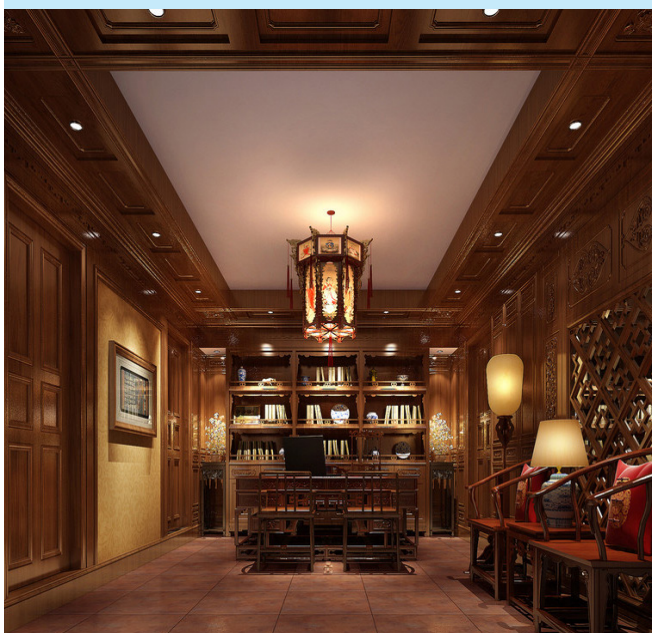

Product Information

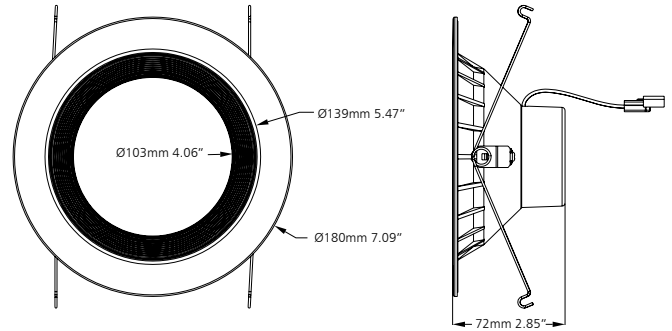

Technical Specifications

Model	Voltage	Power	Power Factor	Lumen (±5%)	Beam angle	CCT	Lifespan	CRI	Dimmable	Dimension
UP-DL60-5&6-12W-D	AC120V	12W	≥0.9	860	100°	2700K	36000h	≥90	Yes	Ø180*72mm
UP-DL60-5&6-12W-D	AC120V	12W	≥0.9	900	100°	3000K	36000h	≥90	Yes	Ø180*72mm
UP-DL60-5&6-12W-D	AC120V	12W	≥0.9	1000	100°	4000K	36000h	≥90	Yes	Ø180*72mm
UP-DL60-5&6-12W-D	AC120V	12W	≥0.9	1030	100°	5000K	36000h	≥90	Yes	Ø180*72mm

Driver data Sheet

Driver data	DIM
Input rated Voltage	AC120V
Frequency	60Hz
Input Voltage	AC90-140V
Efficiency	≥84%
Total load Wattage	12W±1W
Power Factor	≥0.9
Rated input current	≤0.1A
Full load output Voltage	DC54V
Rated output current	240mA
Output current range	240mA±6%
Power tolerance	±5%
Current output tolerance	±6%
Dimming range	8%-100%
Dimmer	Triac dimmers
Short circuit protection	PASS
Over voltage protection	PASS
Over temperature protection	PASS
THD	<18%
Withstand voltage	AC3000V

Fixture Compatibility

Rated Wattage	Electrical Classification	Ingress Protection	Operating Temp	Operating Humidity	Storage Temp
12W	II	IP54	-20°C~45°C	0~90%	-20°C~65°C

Spectral Distribution

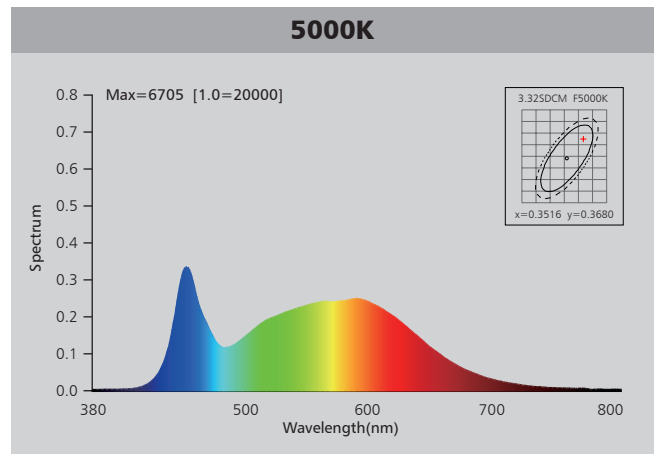
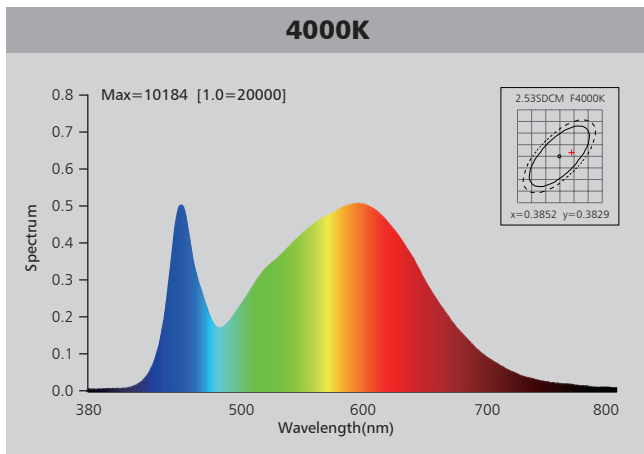
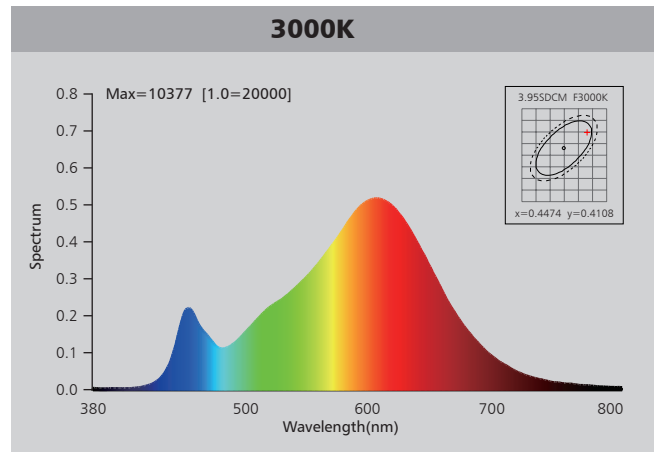
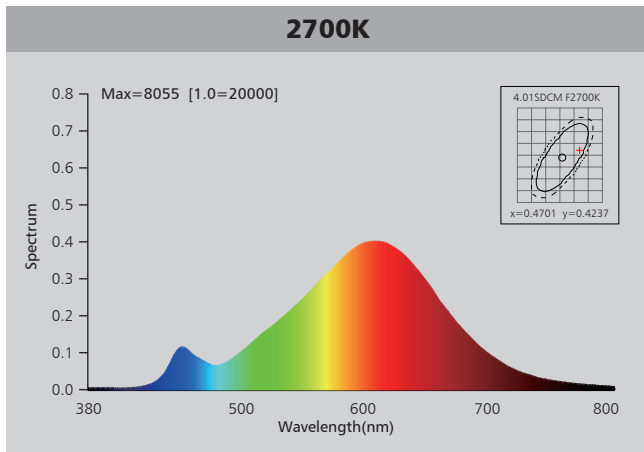

Photometric Diagram

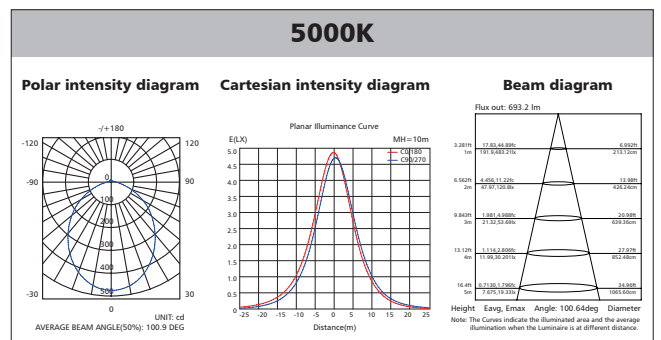
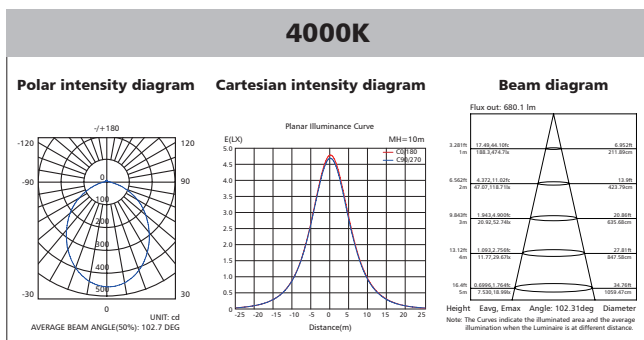
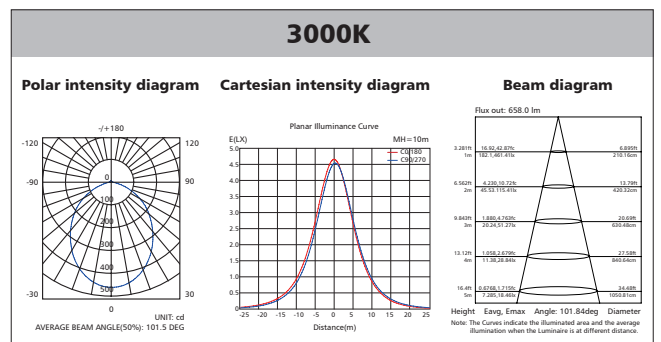
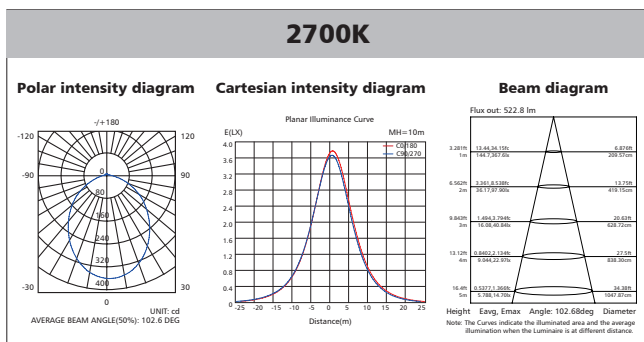

Polar Diagram Comparison

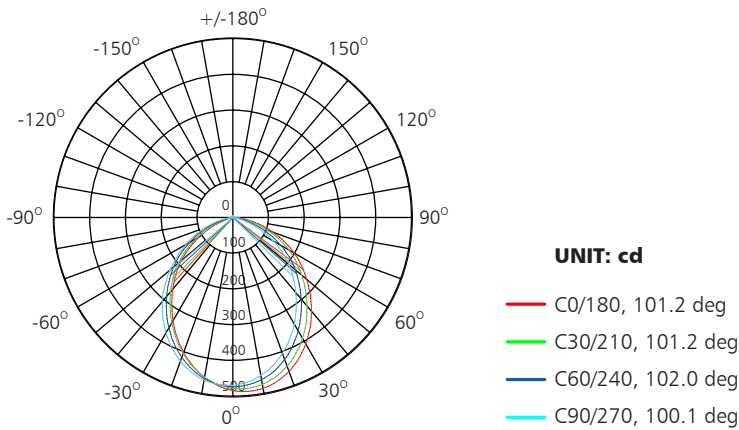

AVERAGE BEAM ANGLE (50%): 100.9DEG



Driver lifetime & LED light decay rate

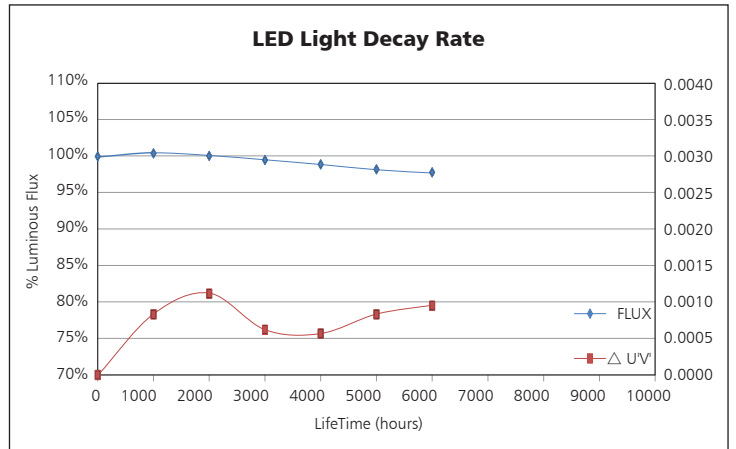
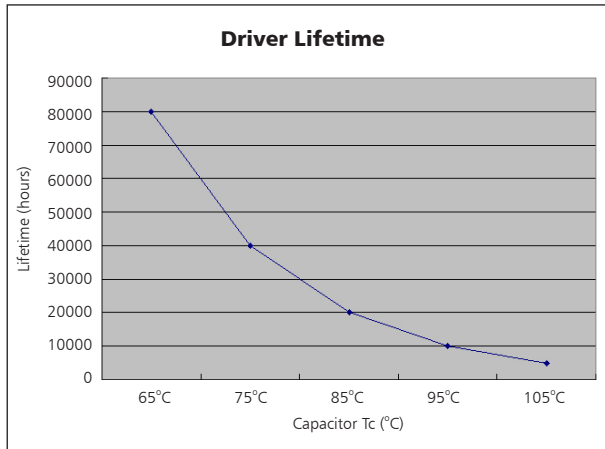

Temperature

- The testing is operated at 25°C
- The lifetime of capacitor, minimum of 5,000 hours if operated at 105°C, will be doubled whenever the temperature drops 10°C
- The highest withstand temperature of IC, MOS could be 120°C
- The highest withstand temperature of LED junction temperature is 150°C

The driver lifespan is based on capacitor working temperature.

Installation

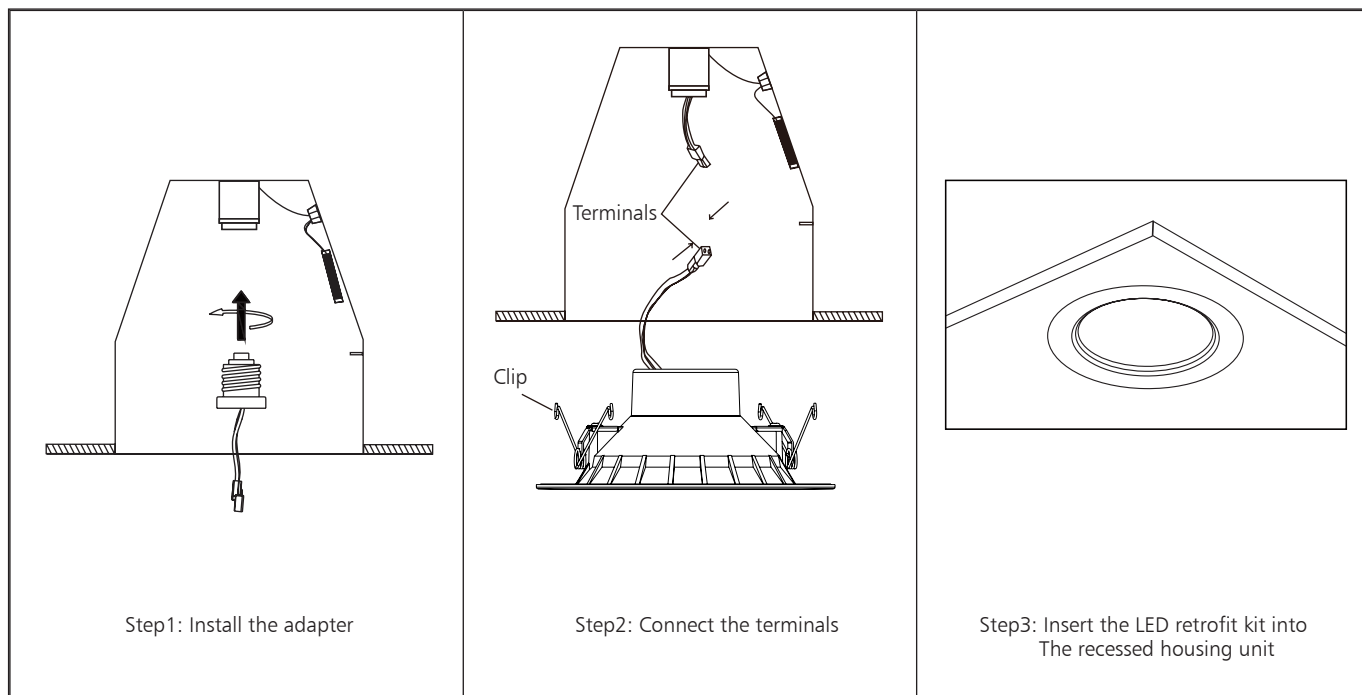

Packaging Information

	SIZE(CM)	N.W/pc (KGS)	G.W.(KGS)	Q'TY(PCS)
Carton	57*38.5*60	0.31	12	30

	CTNS	Q'TY(PCS)	VOLUME(CBM)
20" standard container	210	6300	28
40" standard container	420	12600	56

