



Technical Application Guide for UP-SHINE LED Downlight

UP-DL36-20W(4 inch)

Introduction



Up-shine DL36 downlight retrofit kits are designed with CREE COB LED chip, utilization of high efficient reflector helps to improve lumen output. 4inch, 6inch 8inch and 10inch full sizes with wattage varies from 15W to 50W for different applications. 0-10V dimmable driver works with most of the local dimmers. UL&cUL and energy Star approved, qualified for North America Market.

- Up to 70% energy saving compared to standard CFL
- Long lifetime of 36,000 hours
- 0~10V dimming driver
- 40° wide beam angle
- CCT: 2700K 3000K 4000K 5000K
- No UV/IR light
- Environment friendly, without Mercury or any other hazardous substances

Application notes

- IP20 for indoor use
- Professional electrician for installation only
- Switch off before installation
- Do not touch when in use
- Keep away from hot steam and corrosive gas

Application Areas

It is designed for general lighting applications in office, supermarket, shop, school, hotel, etc. It is also widely used for public areas, such as stairway, lobby, reception, corridors etc.

Certificate



RoHS

Product Information

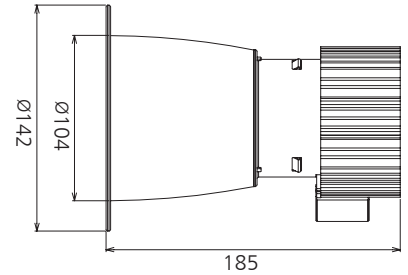

Technical Specifications

Model	Voltage	Power	Power Factor	Lumen (±5%)	Beam angle	CCT	Lifespan	CRI	Dimmable	Dimension
UP-DL36-20W	AC100-277V	20W	≥0.9	1100	40°	2700K	36000h	≥83	Yes	Ø142*185mm
UP-DL36-20W	AC100-277V	20W	≥0.9	1140	40°	3000K	36000h	≥83	Yes	Ø142*185mm
UP-DL36-20W	AC100-277V	20W	≥0.9	1180	40°	4000K	36000h	≥83	Yes	Ø142*185mm
UP-DL36-20W	AC100-277V	20W	≥0.9	1200	40°	5000K	36000h	≥83	Yes	Ø142*185mm

Driver data Sheet

Driver data	DIM
Input rated Voltage	AC100-277V
Frequency	50/60Hz
Input Voltage	AC90-305V
Efficiency	≥85%
Total load Wattage	20W±5%
Power Factor	≥0.9
Rated input current	≤0.25A
Full load output Voltage	DC35-38V
Rated output current	480mA
Output current range	480mA±5%
Power tolerance	±5%
Current output tolerance	±5%
Dimming range	8%-100%
Dimmer	0V-10V dimmers
Short circuit protection	PASS
Over voltage protection	PASS
Over temperature protection	PASS
Withstand voltage	AC3750V

Fixture Compatibility

Rated Wattage	Electrical Classification	Ingress Protection	Operating Temp	Operating Humidity	Storage Temp
20W	II	IP20	-20°C~45°C	0~90%	-20°C~65°C

Spectral Distribution

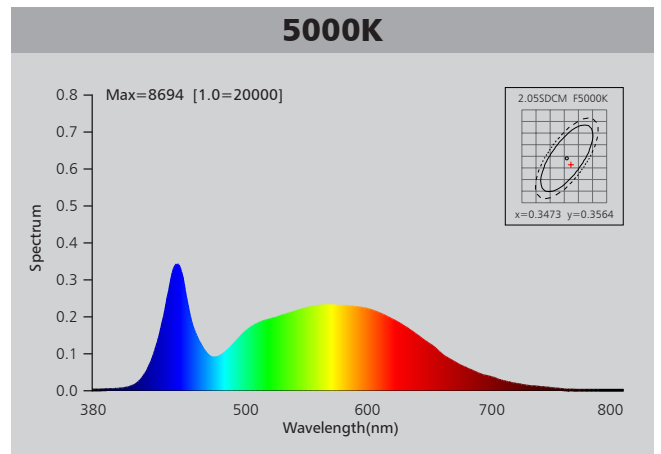
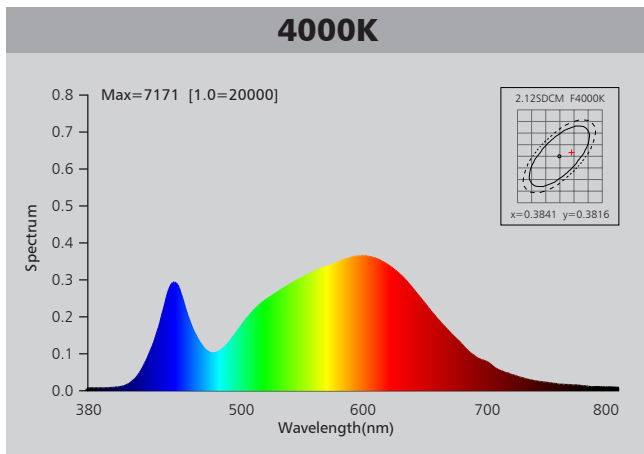
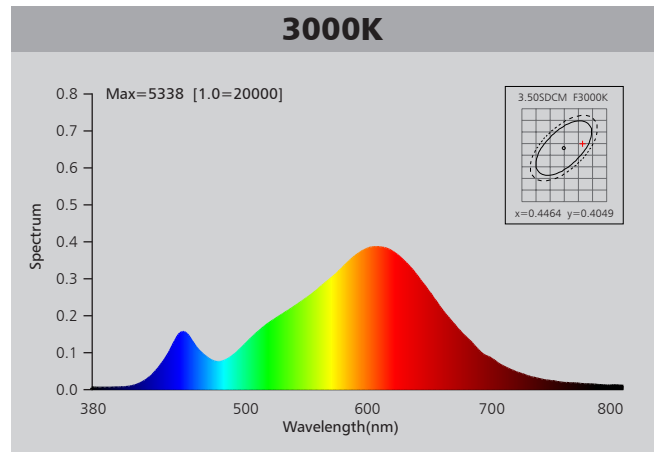
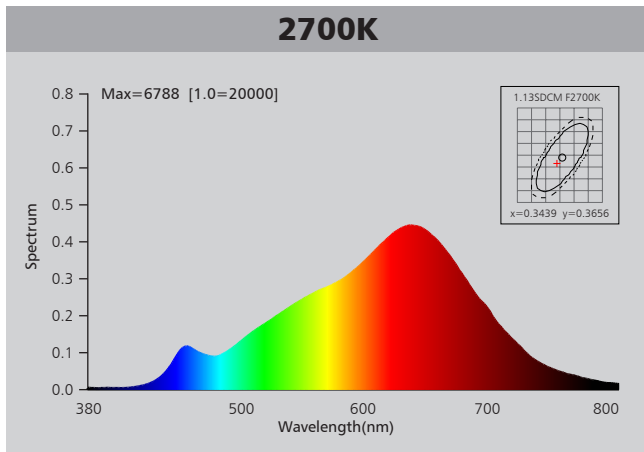

Photometric Diagram

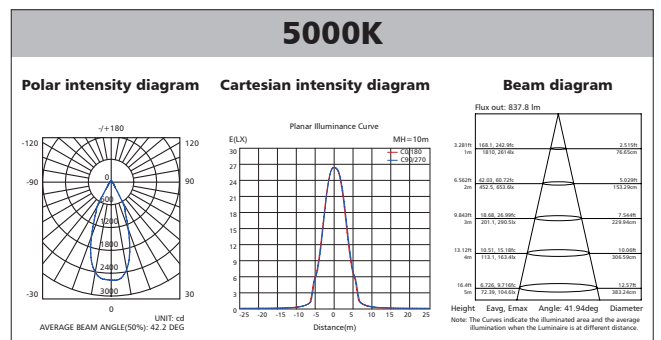
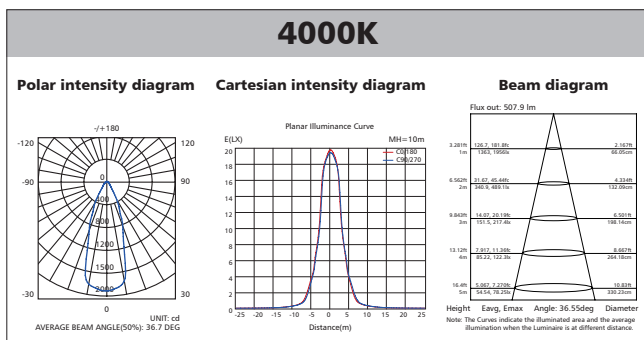
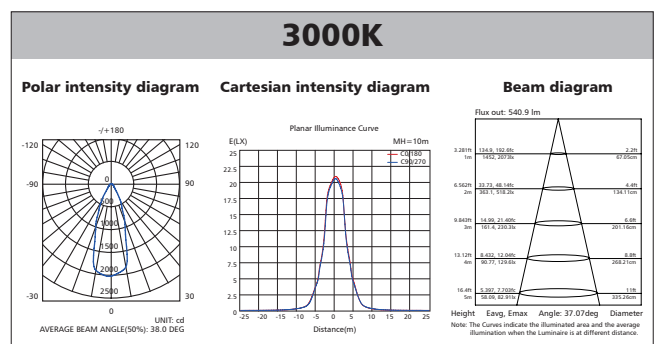
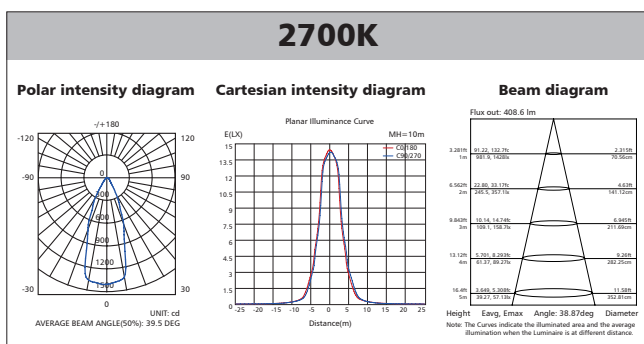

Polar Diagram Comparison

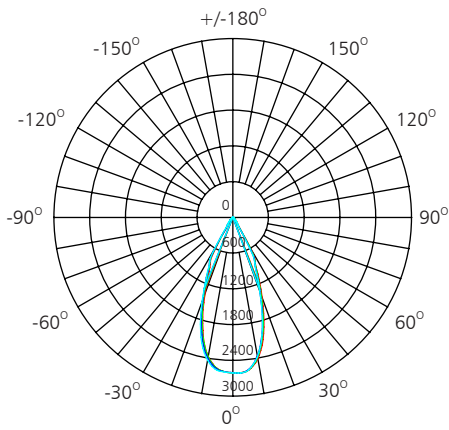

UNIT: cd

- C0/180, 42.2 deg
- C30/210, 42.2 deg
- C60/240, 42.2 deg
- C90/270, 42.3 deg

AVERAGE BEAM ANGLE (50%): 42.2DEG



Driver lifetime & LED light decay rate

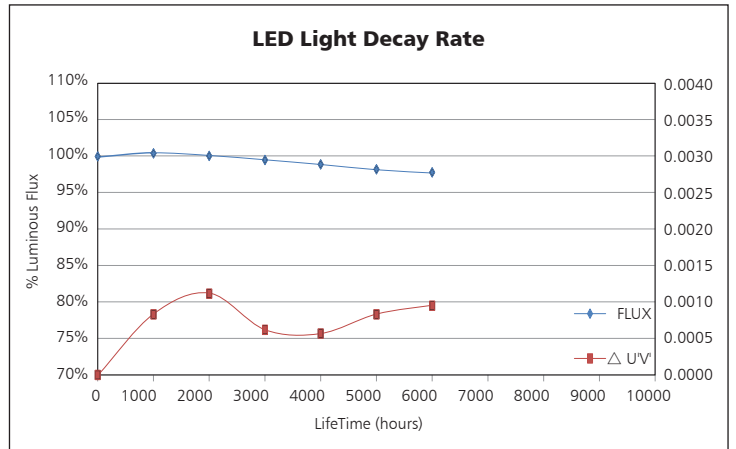
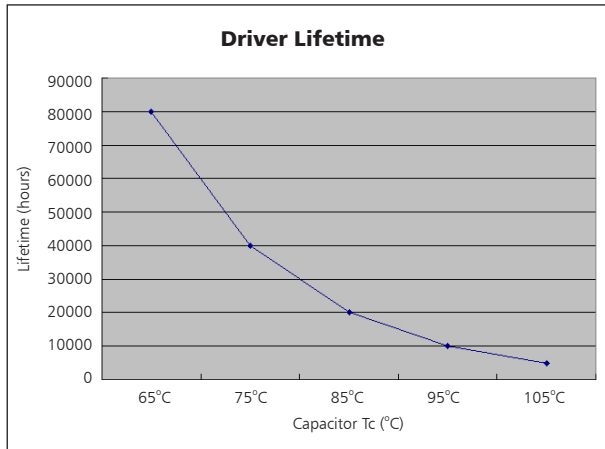

Temperature

- The testing is operated at 25°C
- The lifetime of capacitor, minimum of 5,000 hours if operated at 105°C, will be doubled whenever the temperature drops 10°C
- The highest withstand temperature of IC, MOS could be 120°C
- The highest withstand temperature of LED junction temperature is 150°C

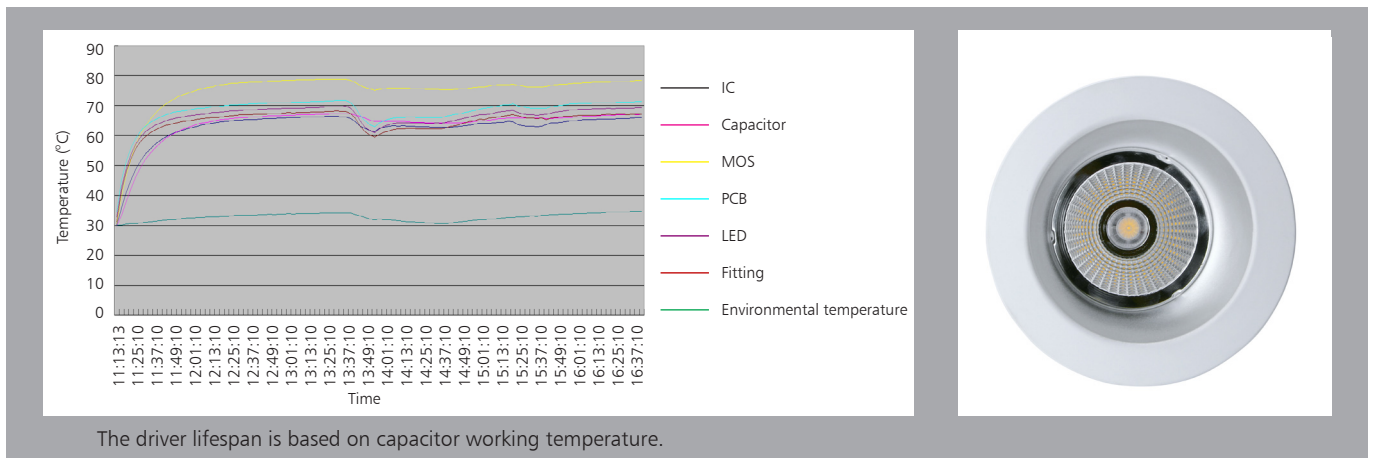

The driver lifespan is based on capacitor working temperature.

Installation

NOTE: RETROFIT KIT IS VOLTAGE SPECIFIC. VERIFY PROPER VOLTAGE BEFORE INSTALLATION.

- Step 1: Remove existing lamp(s)
- Step 2: Remove and discard existing reflector.
- Step 3: Open board of side of J-box.
- Step 4: See 4A and 4B Locate J-box containing supply wires and cut all supply wires leading to the ballast and output lead of ballast. (May remove wires of ballast)
- Step 5: Twist out conduit knockout.
- Step 6: Place LED Driver box thru ceiling cut-out and allow to rest on ceiling.
- Step 7: Install the supply conduit of Driver Box into the junction box.
- Step 8: Connect the supply to the LED Driver. Connect GND to wire of green.
- Step 9: See figure 9, hold the end of the string and pass through the hole on one side of the fixture. press a while penetrate though the hole inside, and make it tighten. (please clarify where the wire is tighted and the tool is not described)
- Step 10: Plug the yellow connector of new LED engine to the yellow connector on the end of the flex conduit provided on the driver box.
- Step 11: Plug the connector of metal to hole of LED engine.
- Step 12: Ensure the mounting frame can hold the weight of the whole reflector.
- Step 13: Restore power after installation of fixture is completed.
- Step 14: After modification completed, attach the Lamping Replacement Marking Label and Cautionary Label which provided with the retrofit kit package to the light fixture. The label shall be visible during relamping, and after installation.

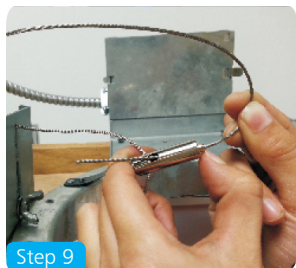
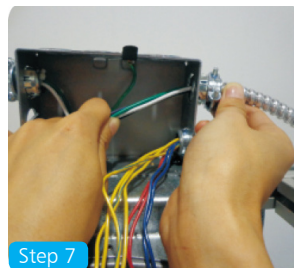
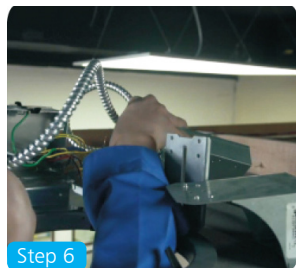
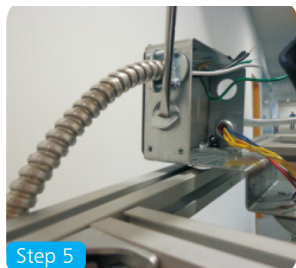
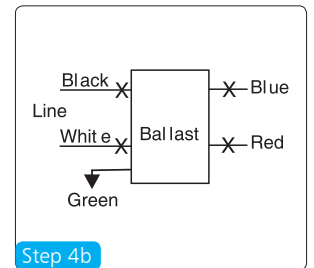
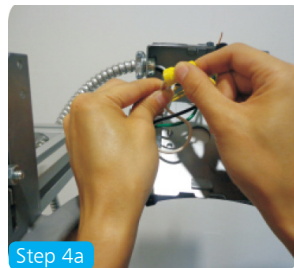

Retrofit Kit Contents

- A** Engine and Light Source
- B** Reflector
- C** LED Driver Box

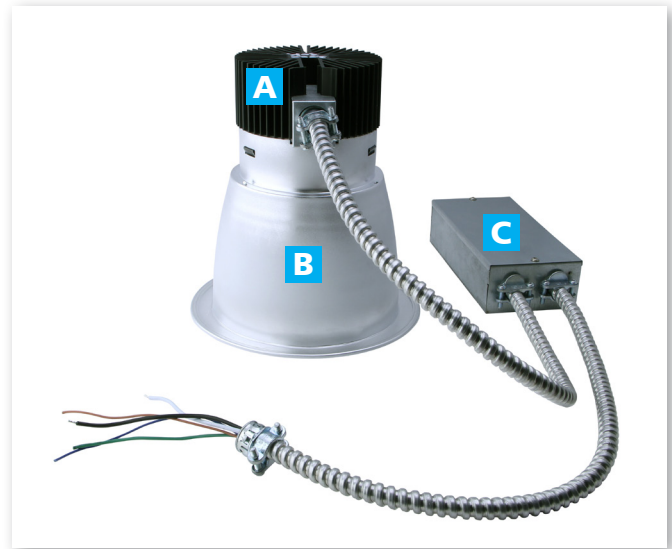

Packaging Information

	SIZE(CM)	N.W/pc (KGS)	G.W.(KGS)	Q'TY(PCS)
Carton	59.5*53.5*23.5	1.5	7	4

	CTNS	Q'TY(PCS)	VOLUME(CBM)
20' standard container	360	1440	28
40' standard container	720	2880	56

