



UPSHINE®



Technical Application
Guide for UP-SHINE
LED Downlight
UP-DL107-6-15W-D

Introduction



DL107 is a led down light with graceful and compact design. The lamp adopts spring installation and can be installed in the ceiling directly without junction box installed in advance, greatly decrease the installation and maintenance cost. Driver box with connection holes reserved can be connected directly to the metal hose. Different color bezels accessories for optional to meet different customers' demands. Can be used in wet or dry locations.

- Up to 70% energy saving compared to standard CFL
- Long lifetime of 50,000 hours
- Triac dim
- 110°wide beam angle
- 142*142mm cutout
- CCT: 3000K 3500K 4000K 5000K
- No UV/IR light
- Environment friendly, without Mercury or any other hazardous substances

Application notes

- Wet location at room side for indoor use only
- Professional electrician for installation only
- Switch off before installation
- Do not touch when in use
- Keep away from hot steam and corrosive gas

Application Areas

It is designed for general lighting applications in office, supermarket, shop, school, hotel, etc. It is also widely used for public areas, such as stairway, lobby, reception, corridors etc.



Product Information

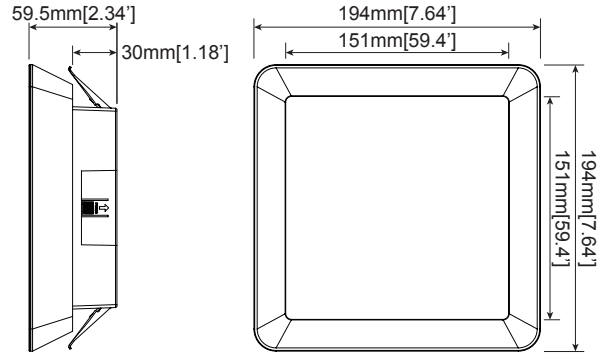

Technical Specifications

Model	Voltage	Power	Power Factor	Lumen (±5%)	Beam angle	CCT	Lifespan	CRI	Dimmable	Dimension
UP-DL107-6-15W-D	AC120V	15W	≥0.9	1455	110°	3000K	50000h	≥80	Yes	194*194*59.5mm cutout 142*142mm
UP-DL107-6-15W-D	AC120V	15W	≥0.9	1575	110°	3500K	50000h	≥80	Yes	194*194*59.5mm cutout 142*142mm
UP-DL107-6-15W-D	AC120V	15W	≥0.9	1620	110°	4000K	50000h	≥80	Yes	194*194*59.5mm cutout 142*142mm
UP-DL107-6-15W-D	AC120V	15W	≥0.9	1620	110°	5000K	50000h	≥80	Yes	194*194*59.5mm cutout 142*142mm

Driver data Sheet

Driver data	DIM
Input rated Voltage	AC120V
Frequency	60Hz
Input Voltage	AC100-130V
Efficiency	≥80%
Total load Wattage	15W±1W
Power Factor	≥0.9
Rated input current	≤0.17A
Full load output Voltage	DC65-75V
Rated output current	180mA
Output current range	180mA±5%
Power tolerance	±5%
Current output tolerance	±5%
Dimming range	8%-100%
Dimmer	Triac dimmers
Short circuit protection	PASS
Over voltage protection	PASS
Over temperature protection	PASS
THD	≤20%
Withstand voltage	—

Fixture Compatibility

Rated Wattage	With ground	Ingress Protection	Operating Temp	Operating Humidity	Storage Temp
15W	Not	Wet location	-20°C~45°C	0~90%	-20°C~65°C

Spectral Distribution

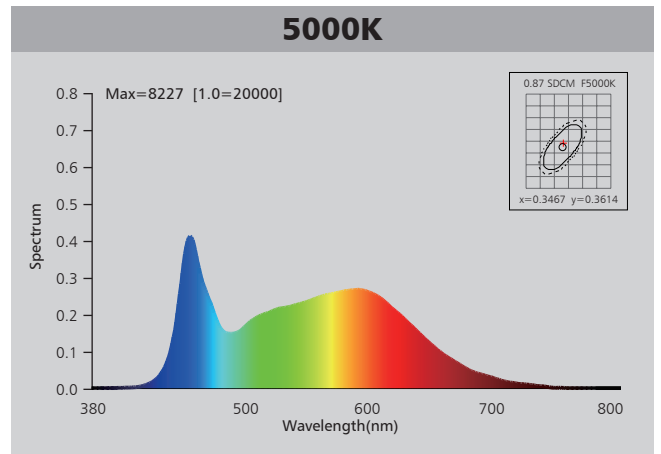
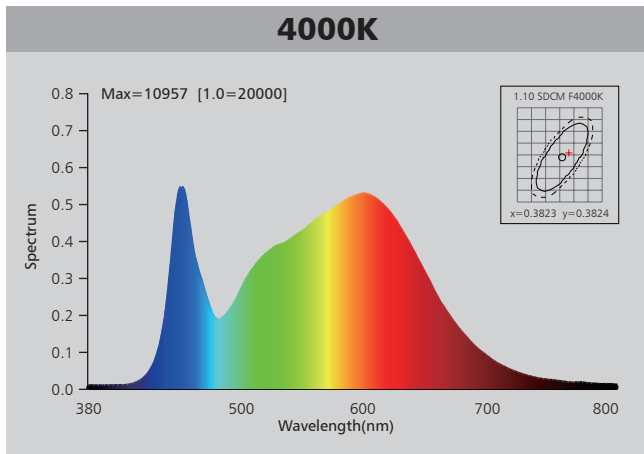
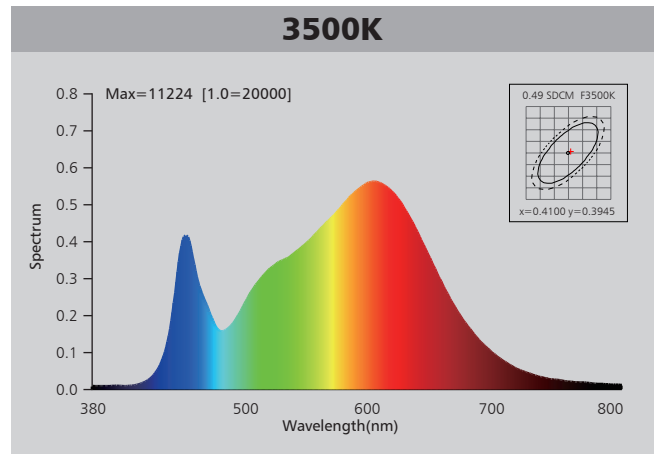
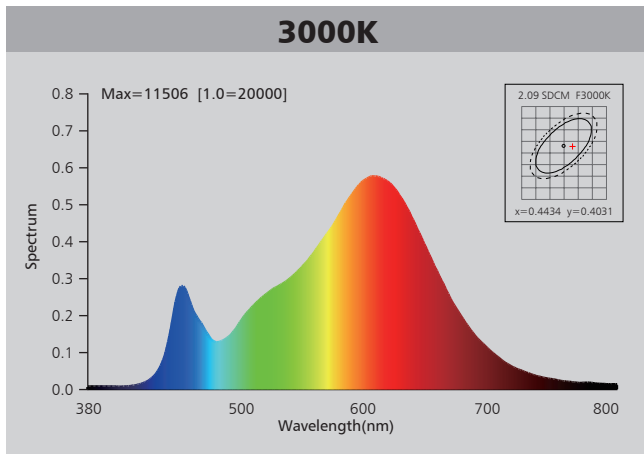

Photometric Diagram

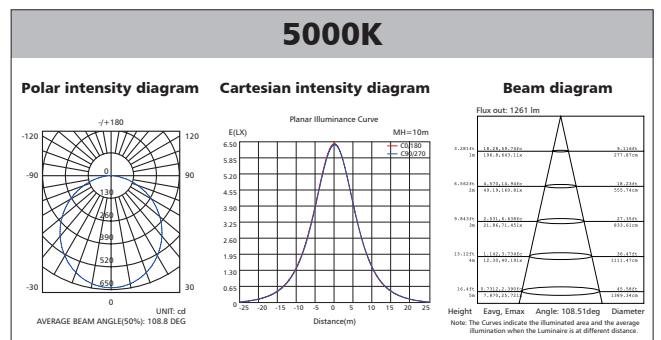
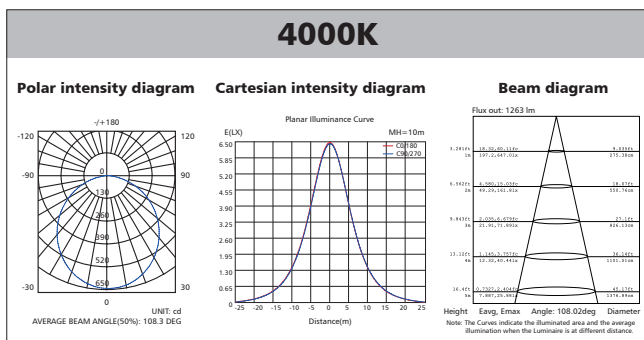
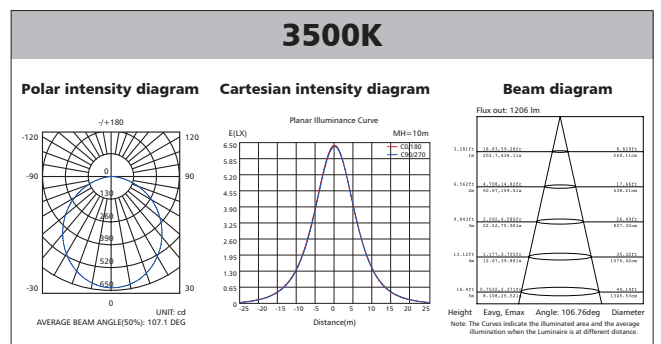
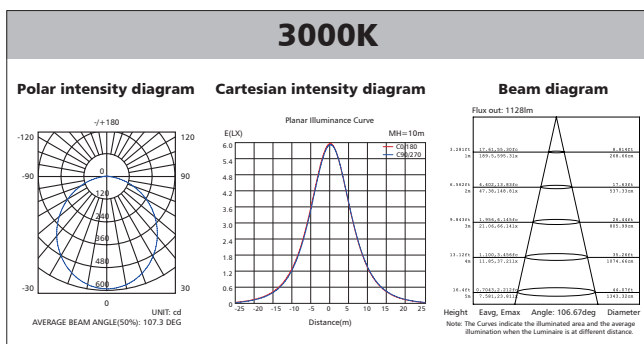

Polar Diagram Comparison

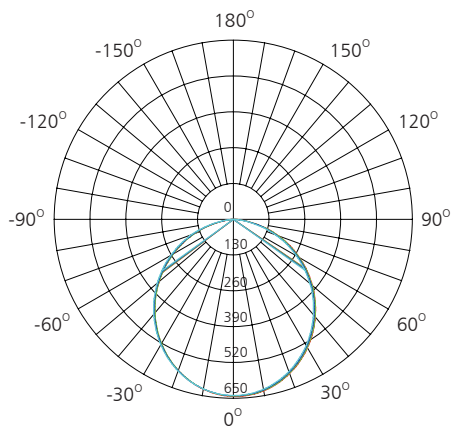

UNIT: cd

- C0/180, 108.8 deg
- C30/210, 108.7 deg
- C60/240, 108.7 deg
- C90/270, 108.8 deg

AVERAGE BEAM ANGLE (50%): 108.8DEG



Driver lifetime & LED light decay rate

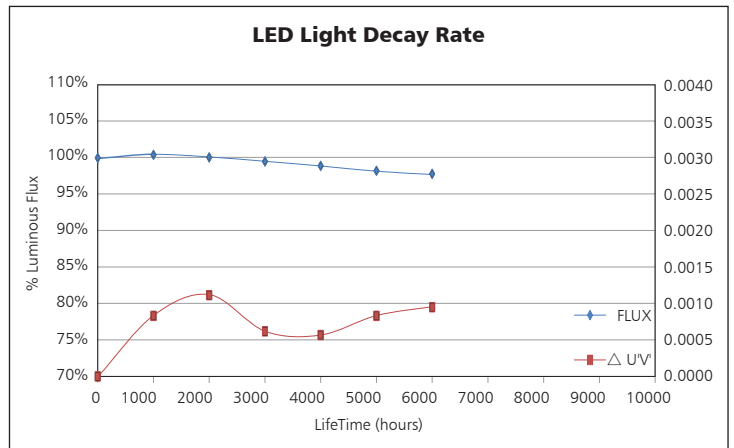
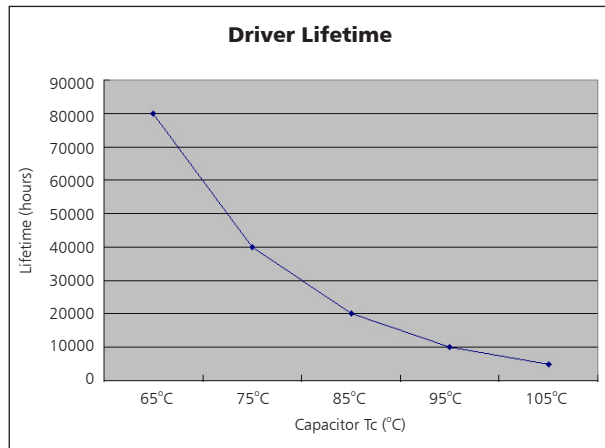

Temperature

- The testing is operated at 25°C
- The lifetime of capacitor, minimum of 5,000 hours if operated at 105°C, will be doubled whenever the temperature drops 10°C.
- The highest withstand temperature of IC, MOS could be 120°C
- The highest withstand temperature of LED junction temperature is 150°C

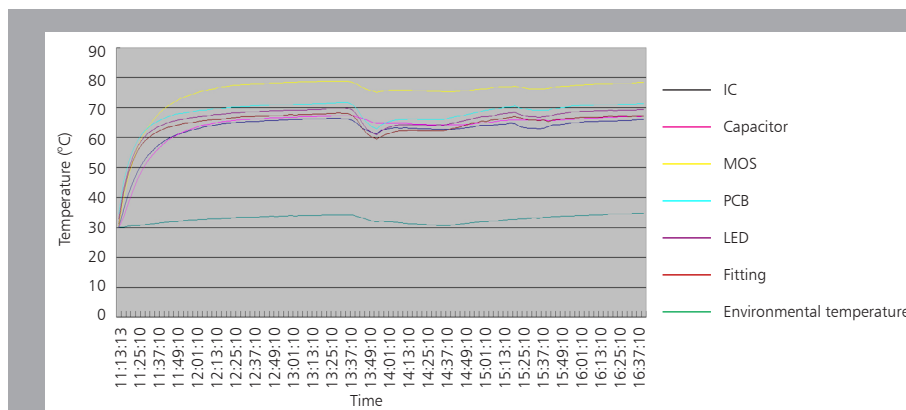

The driver lifespan is based on capacitor working temperature.

Installation

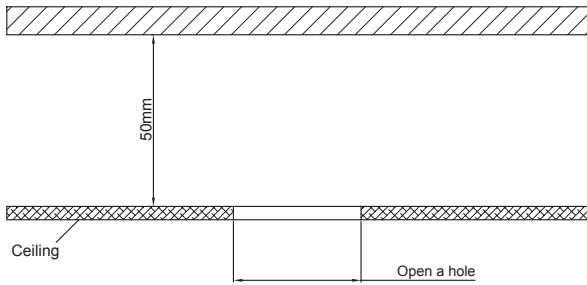

FIG.1

Thermal radiation space and irradiation distance must be ensured. The height of the fixture should be no less than 50mm (see FIG.1)

Opening a hole in ceiling according to cutout size of the lamp (see FIG.1)

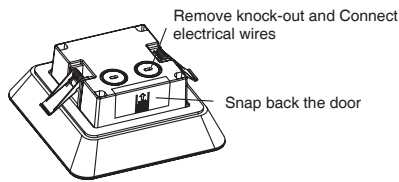

FIG.2

Remove the knockout in driver box with a screw driver, attach line voltage AC supply wires to fixture lead wires (L-Black, N-White) inside the driver box. Secure each connection using the quick connector provided. (see FIG.2).

Put wires back into the driver box and snap back the door into place.

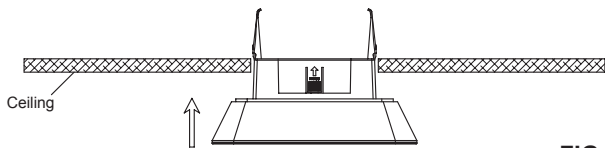

FIG.3

Bend back the spring clips then push the lamp into the hole. (see FIG3).

Installation completed. Switch on. (see FIG4)

Attention: Switch off before installation.

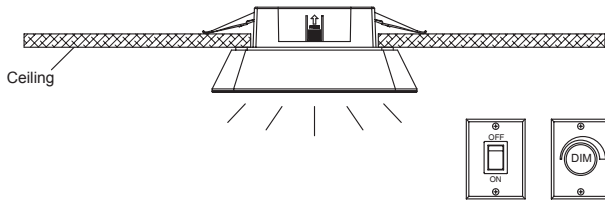

FIG.4

Packaging Information

	SIZE(CM)	N.W/pc (KGS)	G.W.(KGS)	Q'TY(PCS)
Carton	44*44*45	0.49	13.5	24

	CTNS	Q'TY(PCS)	VOLUME(CBM)
20" standard container	316	7584	28
40" standard container	634	15216	56

