



Up-shine<sup>®</sup> Lighting



# Technical Application Guide for UP-SHINE LED Ceiling Spotlight

UP-TL13-20W

# Introduction



Up-shine Ceiling Spotlight adopts die-casting ADC12 with excellent heat dissipation. CRI80 and high efficient COB led chip to assure that high center luminous intensity. It is designed with high transmittance glass, maximum utilization of light output. Adjustable lighting orientation with 350 degree in horizontal direction and 35 in vertical direction provided. Lamp with surface mounted installation, easy to install.

- Up to 70% energy saving compared to standard CFL
- Long lifetime of 40,000 hours
- 24°/36°/45°/60° beam angle
- CCT: 2700K 3000K  
4000K 5000K
- No UV/IR light
- Environment friendly, without Mercury or any other hazardous substances

## Application notes

- IP20 for indoor use only
- Professional electrician for installation only
- Switch off before installation
- Do not touch when in use
- Keep away from hot steam and corrosive gas

## Application Areas

It is suitable for supermarket, specialty store, show window, exhibition hall; focus lighting, decorative and background lighting, where attention is focused on subjects to emphasize special visual points.

## Certificate

CE RoHS



# Product Information

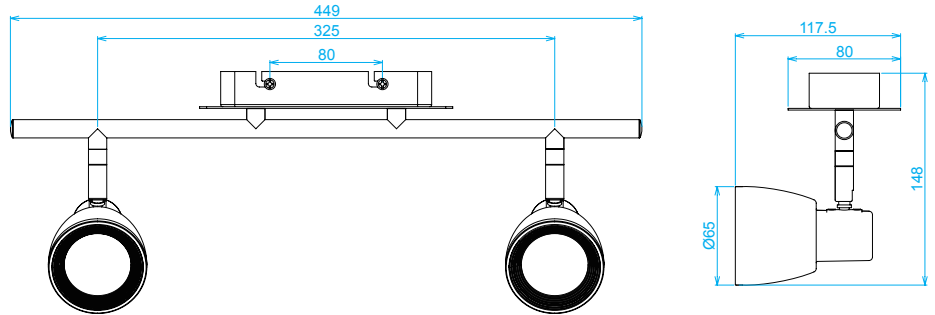

## Technical Specifications

Model	Voltage	Power	Power Factor	Lumen (±5%)	Beam angle	CCT	Lifespan	CRI	Dimmable	Dimension
UP-TL13-20W	AC100-240V	20W	≥0.9	1500	24°/36°/45°/60°	2700K	40000h	≥80	No	449*117.5*148mm
UP-TL13-20W	AC100-240V	20W	≥0.9	1540	24°/36°/45°/60°	3000K	40000h	≥80	No	449*117.5*148mm
UP-TL13-20W	AC100-240V	20W	≥0.9	1600	24°/36°/45°/60°	4000K	40000h	≥80	No	449*117.5*148mm
UP-TL13-20W	AC100-240V	20W	≥0.9	1560	24°/36°/45°/60°	5000K	40000h	≥80	No	449*117.5*148mm
UP-TL13-20W-D	AC230V	20W	≥0.9	1365	24°/36°/45°/60°	2700K	40000h	≥80	Yes	449*117.5*148mm
UP-TL13-20W-D	AC230V	20W	≥0.9	1420	24°/36°/45°/60°	3000K	40000h	≥80	Yes	449*117.5*148mm
UP-TL13-20W-D	AC230V	20W	≥0.9	1470	24°/36°/45°/60°	4000K	40000h	≥80	Yes	449*117.5*148mm
UP-TL13-20W-D	AC230V	20W	≥0.9	1435	24°/36°/45°/60°	5000K	40000h	≥80	Yes	449*117.5*148mm

## Driver data Sheet

Driver data	DIM	Non dim
Input rated Voltage	AC230V	AC100-240V
Frequency	50Hz	50/60Hz
Input Voltage	AC200-240V	AC85-265V
Efficiency	≥78%	≥85%
Total load Wattage	2*10W±0.5W	2*10W±0.5W
Power Factor	≥0.9	≥0.9
Rated input current	≤2*0.06A	≤2*0.12A
Full load output Voltage	DC35-38V	DC24-38V
Rated output current	2*215mA	2*230mA
Output current range	2*215mA±5%	2*230mA±5%
Power tolerance	±5%	±5%
Current output tolerance	±5%	±5%
Dimming range	8%-100%	—
Dimmer	Triac dimmers	—
Short circuit protection	PASS	PASS
Over voltage protection	PASS	PASS
Over temperature protection	PASS	PASS
THD	<18%	<18%
Withstand voltage	AC1500V	AC1500V

## Fixture Compatibility

Rated Wattage	Electrical Classification	Ingress Protection	Operating Temp	Operating Humidity	Storage Temp
20W	I	IP20	-20°C~45°C	0~90%	-20°C~65°C

# Spectral Distribution

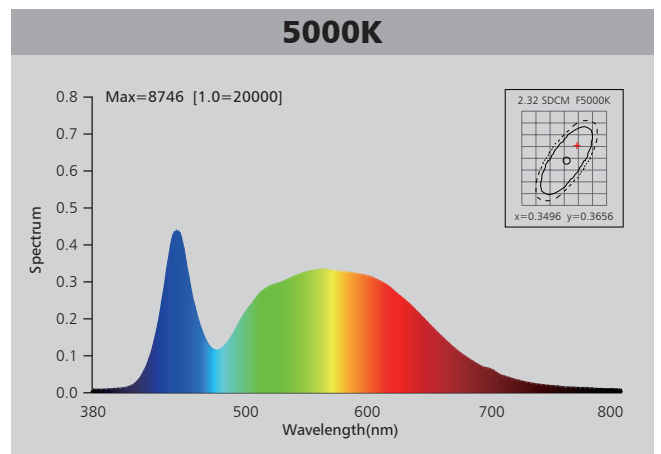
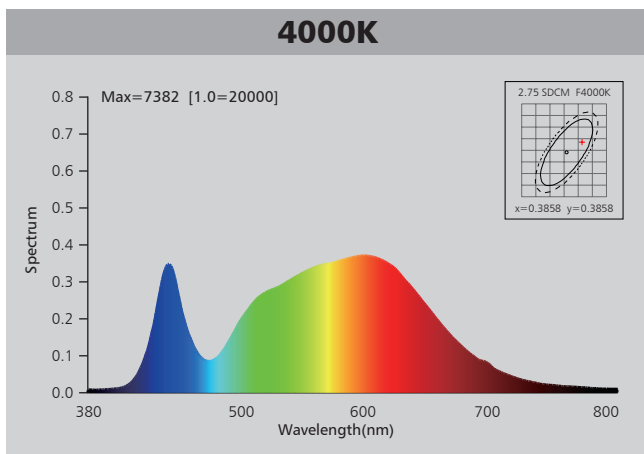
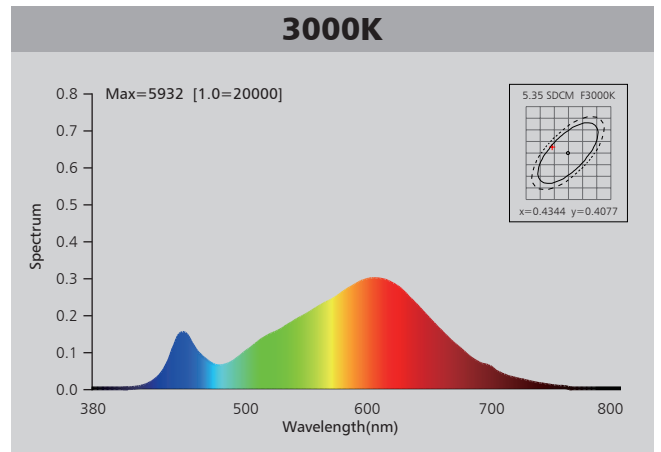
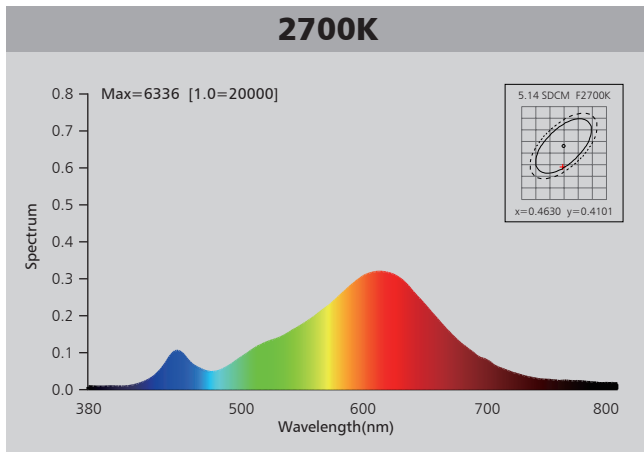

# Photometric Diagram

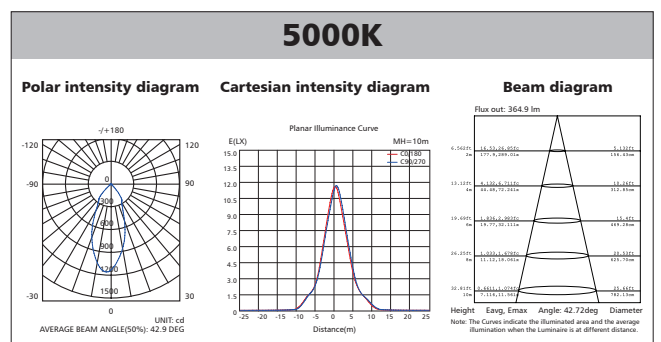
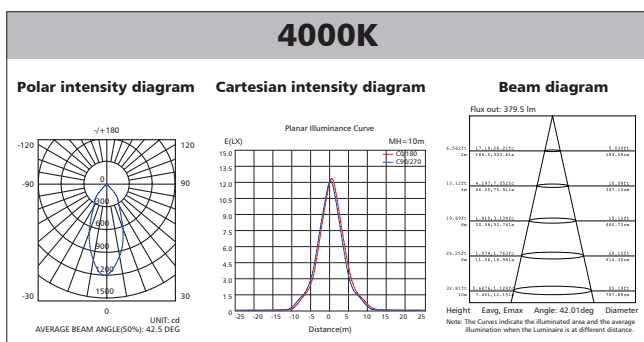
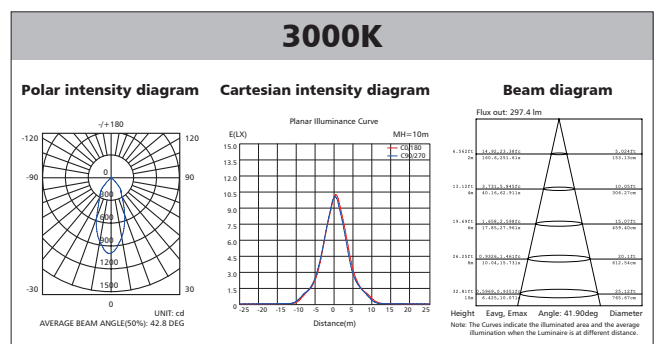
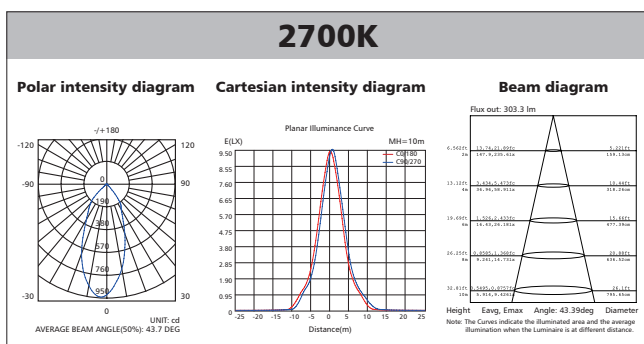

# Polar Diagram Comparison

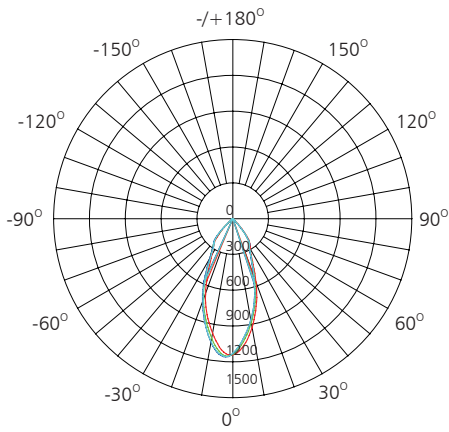

UNIT: cd

- C0/180, 42.8 deg
- C30/210, 43.1 deg
- C60/240, 43.0 deg
- C90/270, 42.8 deg

AVERAGE BEAM ANGLE (50%): 42.9DEG



# Driver lifetime & LED light decay rate

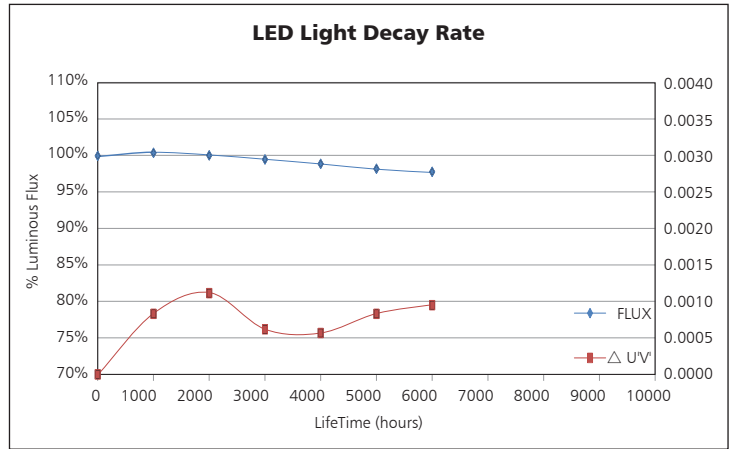
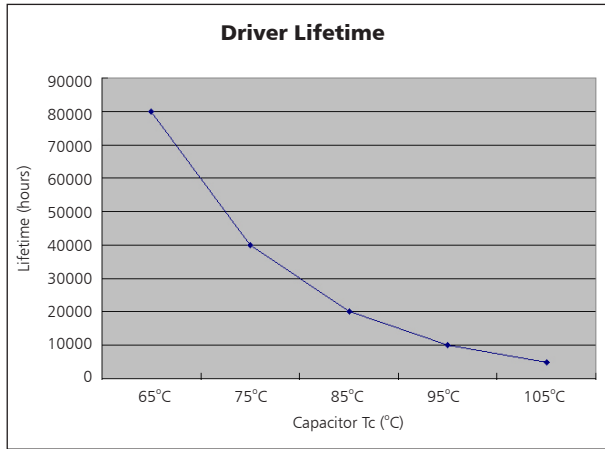

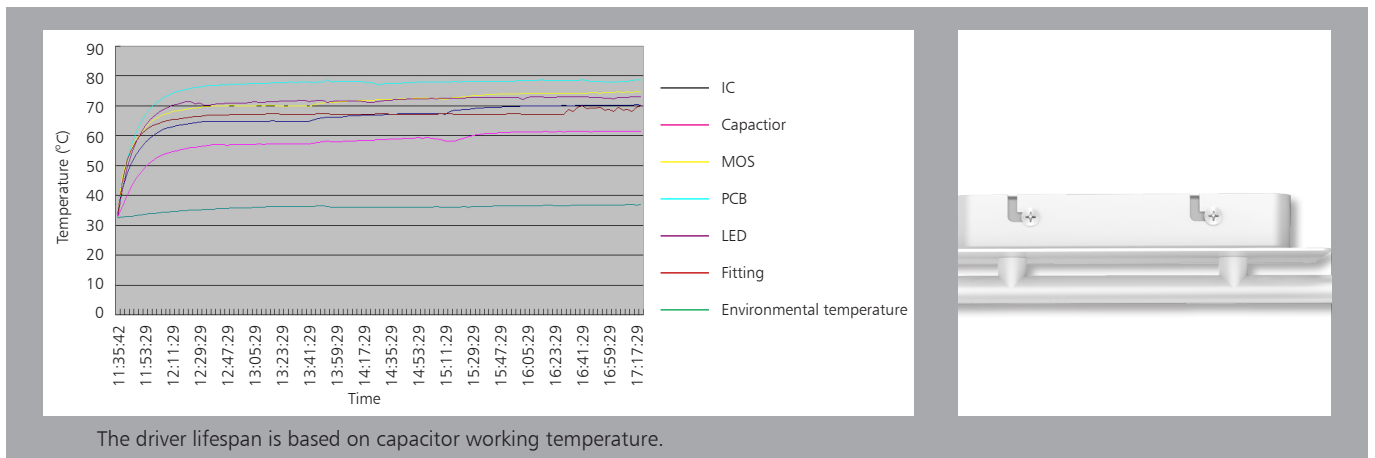

# Temperature

- The testing is operated at 25°C
- The lifetime of capacitor, minimum of 5,000 hours if operated at 105°C, will be doubled whenever the temperature drops 10°C
- The highest withstand temperature of IC, MOS could be 120°C
- The highest withstand temperature of LED junction temperature is 150°C

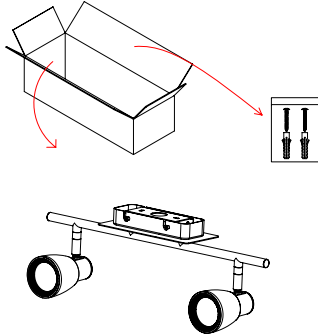
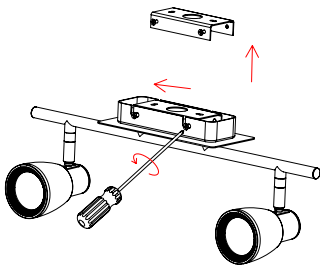

# Installation

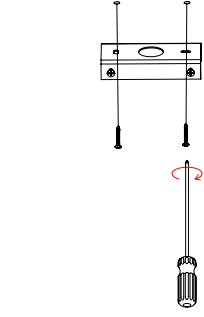
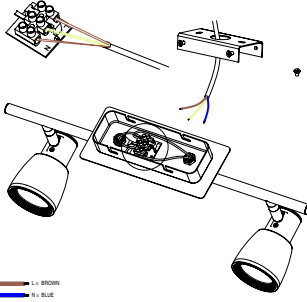
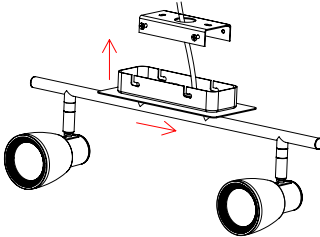
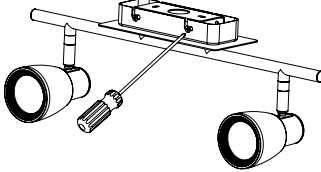
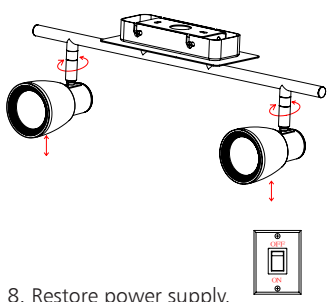
 <p>1. Isolate the mains supply before connection. Unpack the luminaire and accessory pack.</p>	 <p>2. Take bracket apart by loosening bracket screw.</p>	 <p>3. Knock-in the plastic anchors into the hole on ceiling, 70mm of hole distance.</p>	 <p>4. Fix bracket with screws on ceiling.</p>
 <p>5. Feed mains cable "L", "N", "G" to terminal block respectively.</p> <p><small>L: BROWN N: BLUE G: YELLOW-GREEN</small></p>	 <p>6. Fix ceiling spotlight light to bracket on ceiling.</p>	 <p>7. Fasten the bracket screw.</p>	 <p>8. Restore power supply, switch on and test for correct operation. Lamp head adjustable if needed.</p>

# Packaging Information

	SIZE(CM)	N.W/pc (KGS)	G.W.(KGS)	Q'TY(PCS)
Carton	49*35*40	1	7.5	6

	CTNS	Q'TY(PCS)	VOLUME(CBM)
20' standard container	402	2412	28
40' standard container	804	4824	56

