



Technical Application Guide for UP-SHINE LED Spotlight

UP-SP77GU10-6W

Introduction



LED Spotlight adopts COB LED, with high brightness and slight light decay. Excellent heat dissipation with aluminum heatsink and good color rendering index up to 80. MR16, GU10 base available, easy installation, with direct replacement of the traditional halogen. Dimmable version achieves great compatibility to worldwide famous brand dimmers.

- Up to 70% energy saving compared to halogen lamp
- Long lifetime of 40,000 hours
- Dimmable when using triac dimmer
- 38° 60° beam angle
- Standard 50mm diameter
- CCT: 3000K 4000K
5000K 5700K
- No UV/IR light
- Environment friendly, without Mercury or any other hazardous substances

Application notes

- IP20 for indoor use
- Professional electrician for installation only
- Switch off before installation
- Do not touch when in use
- Keep away from hot steam and corrosive gas

Application Areas

Application: It is widely used in residential lighting, such as bedroom, living room dining room, kitchen etc. Also commercial lighting, like hotel, restaurant, bar, shops etc.

Certificates

CE **RoHS**

Product Information

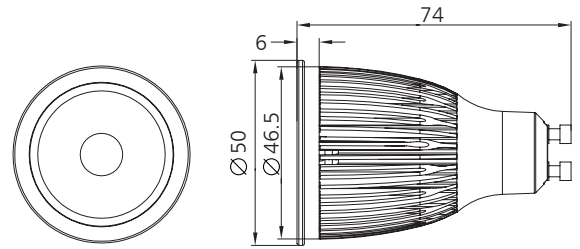

Technical Specifications

Model	Voltage	Power	Power Factor	Lumen (±5%)	Beam angle	CCT	Lifespan	CRI	Dimmable	Dimension
UP-SP77GU10-6W	AC100-240V	6W	≥0.6	400	38°/60°	3000K	40000h	≥80	No	Ø50*74mm
UP-SP77GU10-6W	AC100-240V	6W	≥0.6	430	38°/60°	4000K	40000h	≥80	No	Ø50*74mm
UP-SP77GU10-6W	AC100-240V	6W	≥0.6	450	38°/60°	5000K	40000h	≥80	No	Ø50*74mm
UP-SP77GU10-6W	AC100-240V	6W	≥0.6	460	38°/60°	5700K	40000h	≥80	No	Ø50*74mm
UP-SP77GU10-6WD	AC230V	6W	≥0.9	370	38°/60°	3000K	40000h	≥80	Yes	Ø50*74mm
UP-SP77GU10-6WD	AC230V	6W	≥0.9	400	38°/60°	4000K	40000h	≥80	Yes	Ø50*74mm
UP-SP77GU10-6WD	AC230V	6W	≥0.9	420	38°/60°	5000K	40000h	≥80	Yes	Ø50*74mm
UP-SP77GU10-6WD	AC230V	6W	≥0.9	420	38°/60°	5700K	40000h	≥80	Yes	Ø50*74mm

Driver data Sheet

Driver data	DIM	Non-dim
Input rated Voltage	AC230V	AC100-240V
Frequency	50Hz	50/60Hz
Input Voltage	AC200-240V	AC85-265V
Efficiency	≥75%	≥75%
Total load Wattage	6W±0.5W	6W±0.5W
Power Factor	≥0.9	≥0.6
Rated input current	≤0.04A	≤0.1A
Full load output Voltage	DC9-10V	DC9-10V
Rated output current	430mA	430mA
Output current range	430mA±5%	430mA±5%
Power tolerance	±5%	±5%
Current output tolerance	±5%	±5%
Dimming range	5%-100%	—
DIM	Triac dimmers	—
Short circuit protection	PASS	PASS
Over voltage protection	PASS	PASS
Over temperature protection	PASS	PASS
Withstand voltage	AC3750V	AC3750V

Fixture Compatibility

Rated Wattage	Electrical Classification	Ingress Protection	Operating Temp	Operating Humidity	Storage Temp
6W	II	IP20	-20°C~45°C	0~90%	-20°C~65°C

Spectral Distribution

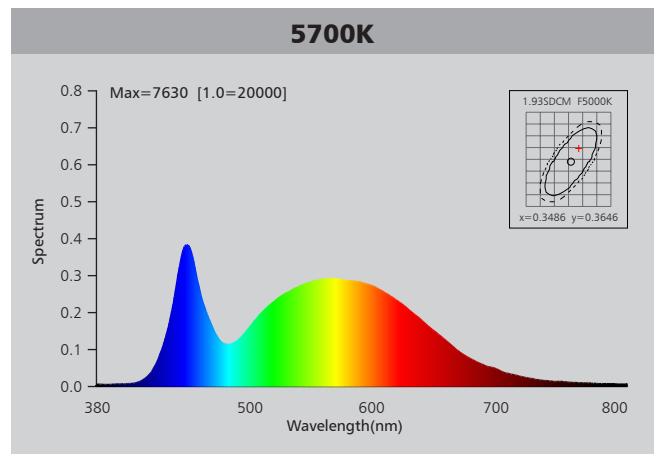
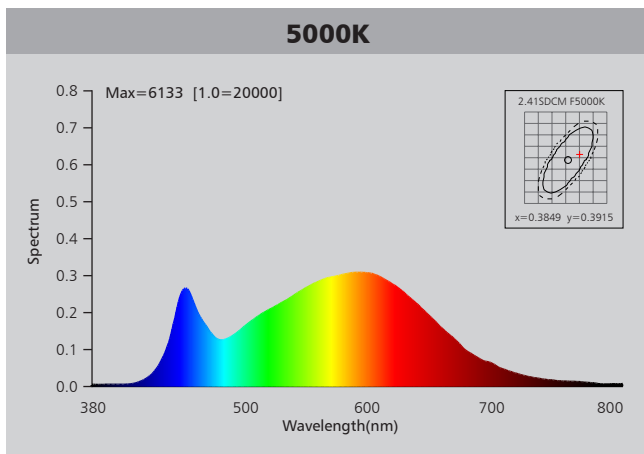
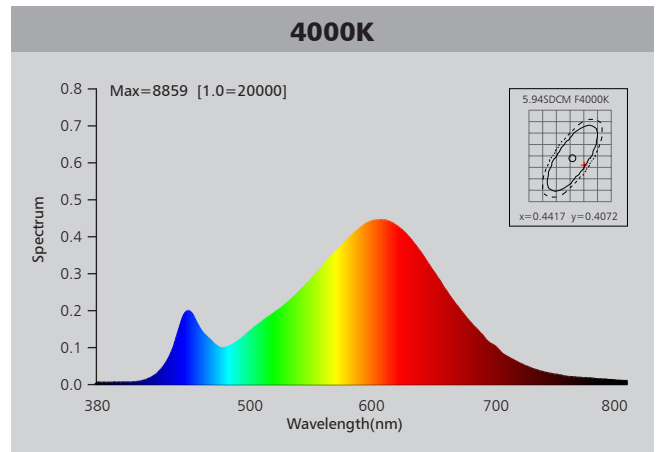
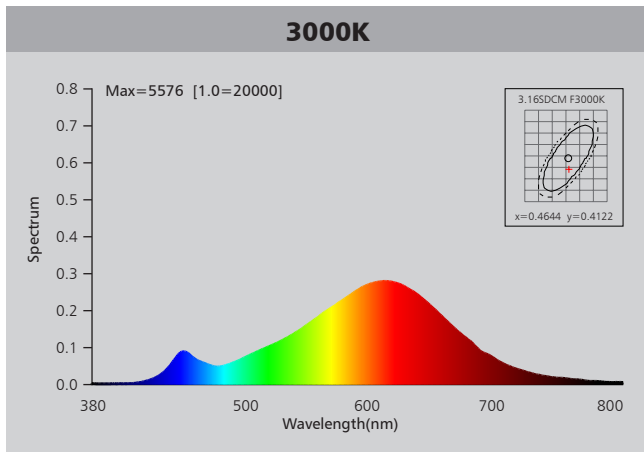

Photometric Diagram

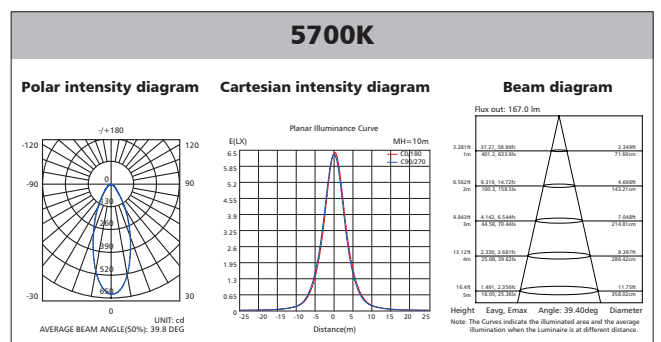
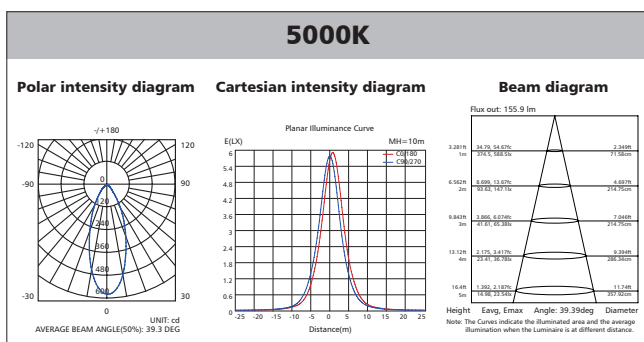
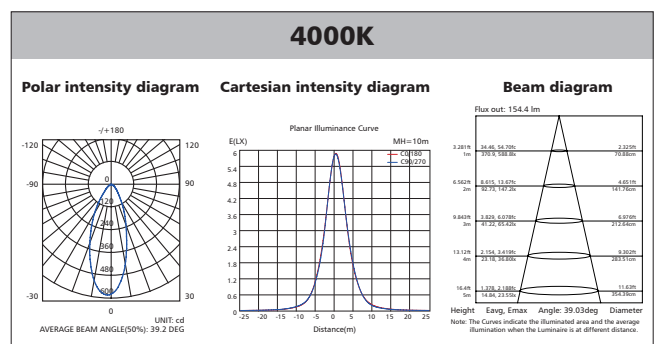
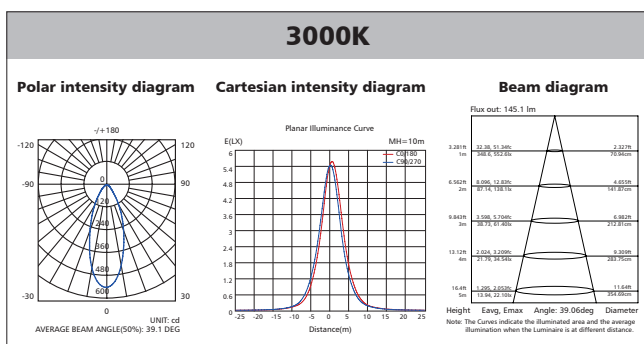

Polar Diagram Comparison

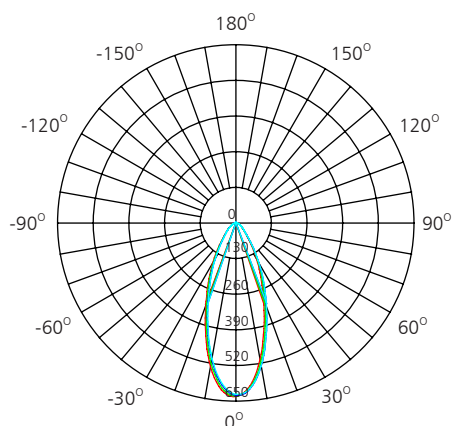

UNIT: cd

- C0/180, 39.4 deg
- C30/210, 39.7 deg
- C60/240, 40.0 deg
- C90/270, 40.0 deg



AVERAGE BEAM ANGLE (50%): 39.8 DEG

Driver lifetime & LED light decay rate

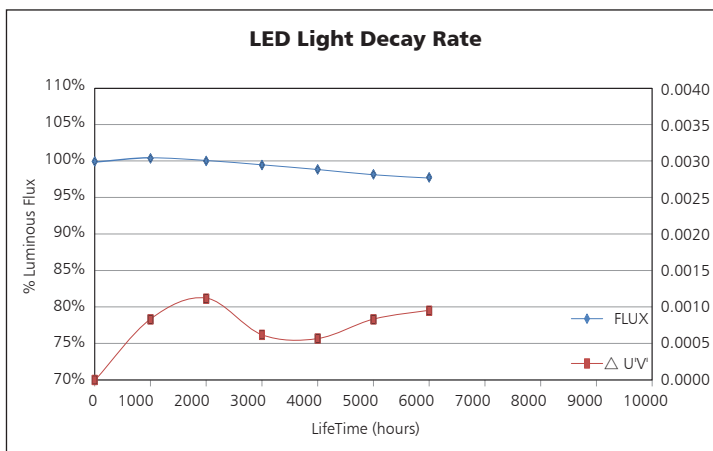
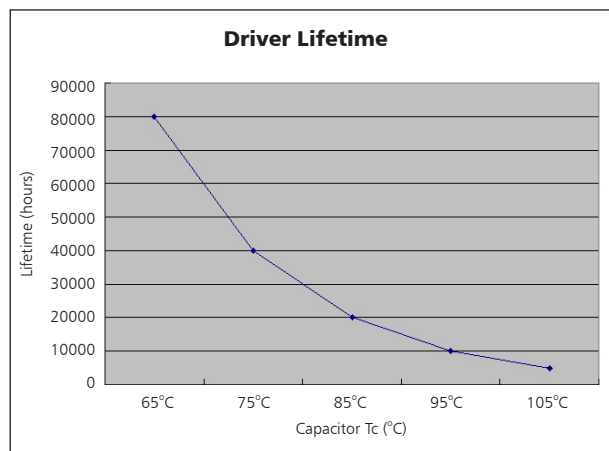

Temperature

- The testing is operated at 25°C
- The lifetime of capacitor, minimum of 5,000 hours if operated at 105°C, will be doubled whenever the temperature drops 10°C
- The highest withstand temperature of IC, MOS could be 120°C
- The highest withstand temperature of LED junction temperature is 150°C

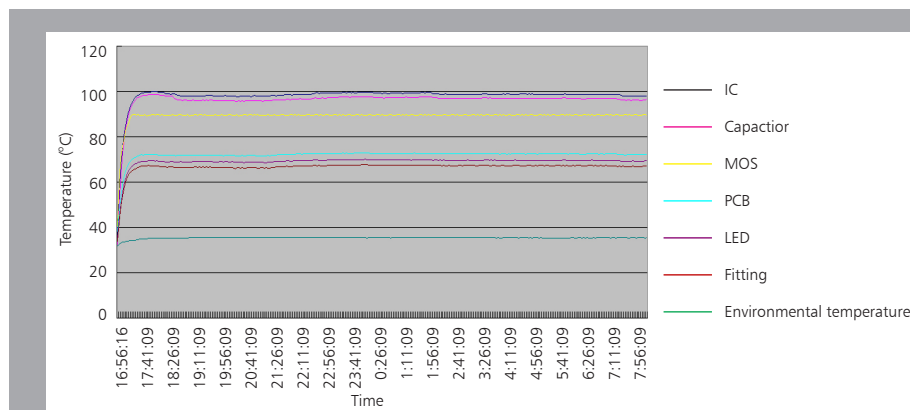

The driver lifespan is based on capacitor working temperature.

Installation

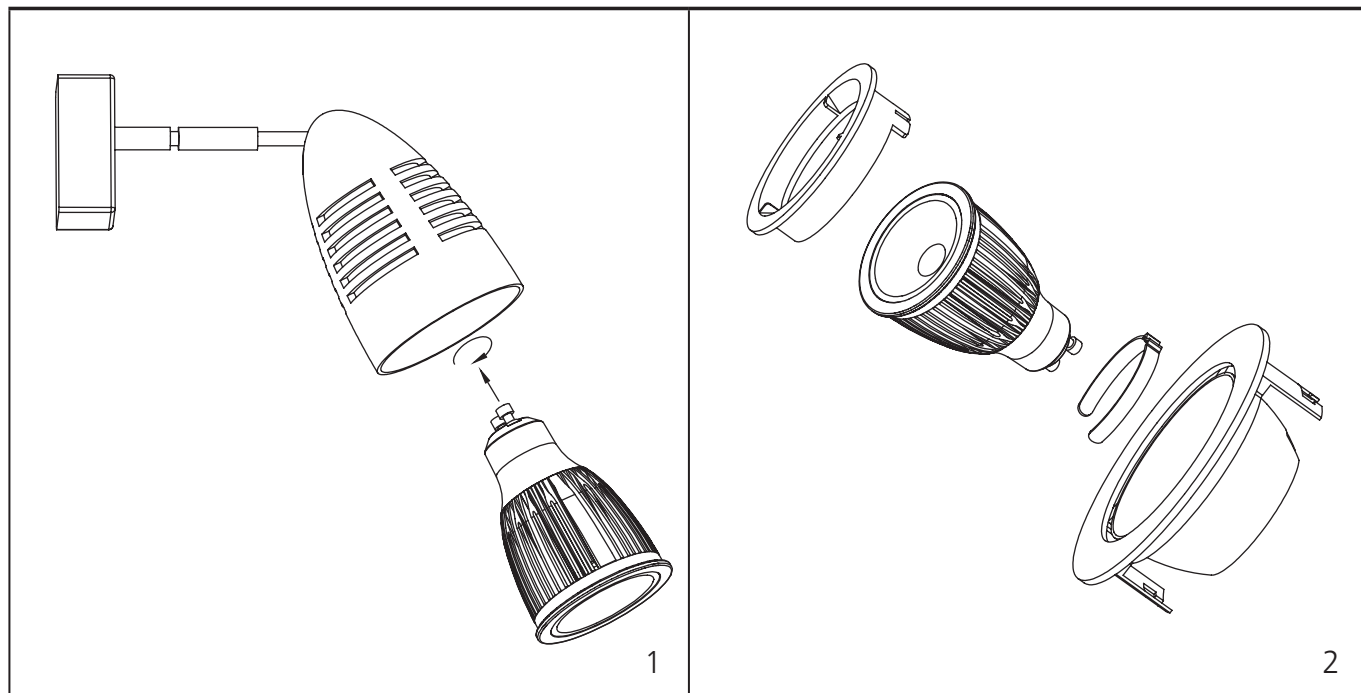

Packaging Information

	SIZE(CM)	N.W/pc (KGS)	G.W.(KGS)	Q'TY(PCS)
Carton	29*29*36.5	0.075	10.56	100

	CTNS	Q'TY(PCS)	VOLUME(CBM)
20" standard container	903	90300	28
40" standard container	1806	180600	56

