



UPSHINE®



Technical Application
Guide for UP-SHINE
LED Panel Light

UP-PL2419-15W

Introduction



Super Slim round panel provided in full diameter, adopting SMD led chip. External driver comes with triac dim, it shares great popularity by perfect dimming range and great compatibility with worldwide dimmers. The ultra slim profile fits perfectly for all working places.

- Up to 80% energy saving compared to standard CFL
- Long lifetime of 40,000 hours
- Triac dim, 0-10V dim
- 120° wide beam angle
- 230mm cutout
- CCT: 3000K 4000K
5000K 5700K
- No UV/IR light
- Environment friendly, without Mercury or any other hazardous substances

Application notes

- IP20 for indoor use only
- Professional electrician for installation only
- Switch off before installation
- Do not touch when in use
- Keep away from hot steam and corrosive gas

Application Areas

Widely used for various commercial lighting and residential lighting applications, such as offices, shopping mall, hotel, restaurant, hospital, home lighting etc.

Certificates

CE RoHS SAA



Product Information

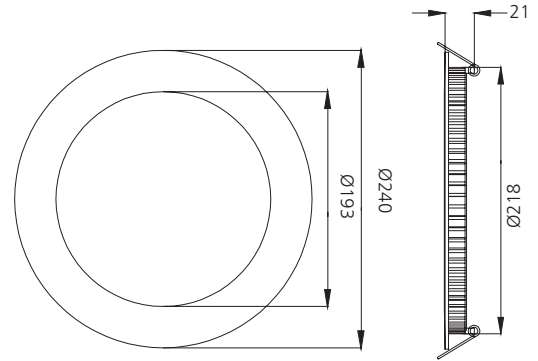

Technical Specifications

Model	Voltage	Power	Power Factor	Lumen (±5%)	Beam angle	CCT	Lifespan	CRI	Dimmable	Dimension
UP-PL2419-15W	AC230V	15W	≥0.9	980	120°	3000K	40000h	≥80	No	Ø240*21mm cutout 230mm
UP-PL2419-15W	AC230V	15W	≥0.9	1050	120°	4000K	40000h	≥80	No	Ø240*21mm cutout 230mm
UP-PL2419-15W	AC230V	15W	≥0.9	1100	120°	5000K	40000h	≥80	No	Ø240*21mm cutout 230mm
UP-PL2419-15W	AC230V	15W	≥0.9	1180	120°	5700K	40000h	≥80	No	Ø240*21mm cutout 230mm
UP-PL2419-15W-D	AC230V	15W	≥0.9	950	120°	3000K	40000h	≥80	Yes	Ø240*21mm cutout 230mm
UP-PL2419-15W-D	AC230V	15W	≥0.9	990	120°	4000K	40000h	≥80	Yes	Ø240*21mm cutout 230mm
UP-PL2419-15W-D	AC230V	15W	≥0.9	1080	120°	5000K	40000h	≥80	Yes	Ø240*21mm cutout 230mm
UP-PL2419-15W-D	AC230V	15W	≥0.9	1130	120°	5700K	40000h	≥80	Yes	Ø240*21mm cutout 230mm

Driver data Sheet

Driver data	DIM	Non-dim
Input rated Voltage	AC230V	AC230V
Frequency	50HZ	50HZ
Input Voltage	AC200-240V	AC200-240V
Efficiency	≥78%	≥82%
Total load Wattage	15W±1W	15W±1W
Power Factor	≥0.9	≥0.9
Rated input current	≤0.08A	≤0.08A
Full load output Voltage	DC33-39V	DC33-39V
Rated output current	330mA	350mA
Output current range	330mA±5%	350mA±5%
Power tolerance	±5%	±5%
Current output tolerance	±5%	±5%
Dimming range	8%-100%	—
Dimmer	Triac dimmers	—
Short circuit protection	PASS	PASS
Over voltage protection	PASS	PASS
Over temperature protection	PASS	PASS
Withstand voltage	AC3750V	AC3750V

Fixture Compatibility

Rated Wattage	Electrical Classification	Ingress Protection	Operating Temp	Operating Humidity	Storage Temp
15W	II	IP20	-20°C~45°C	0~90%	-20°C~65°C

Spectral Distribution

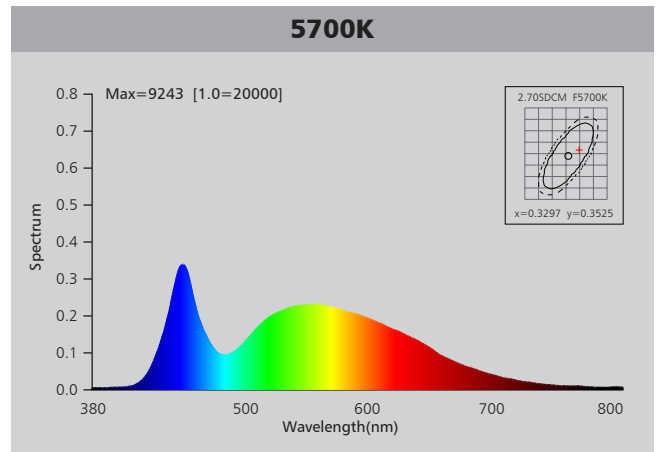
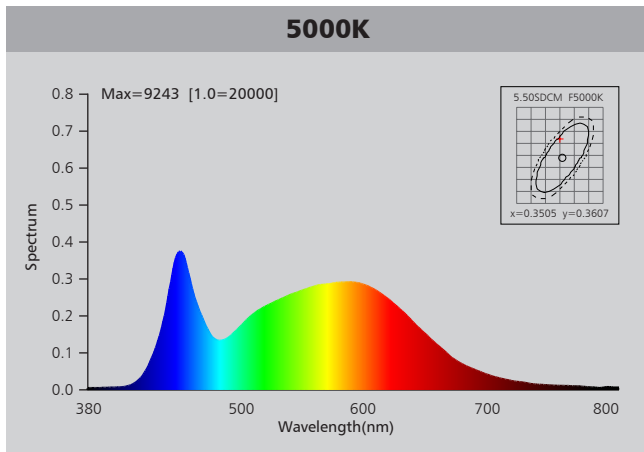
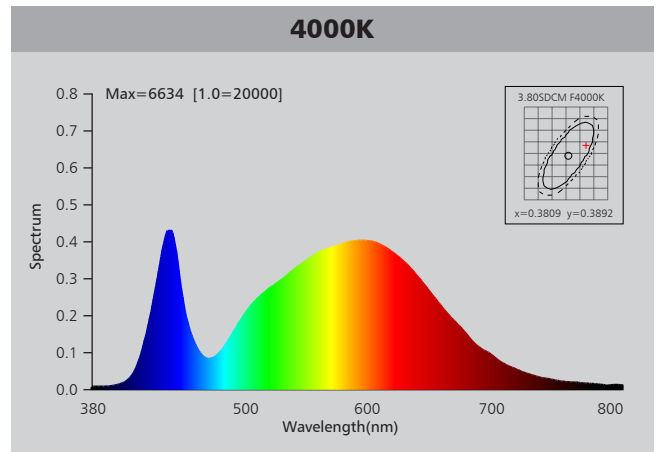
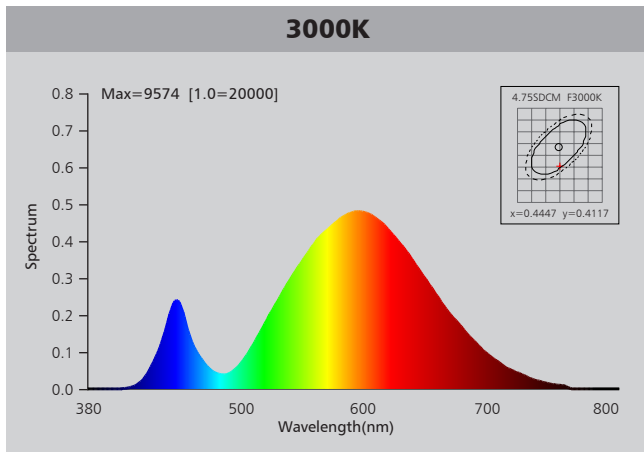

Photometric Diagram

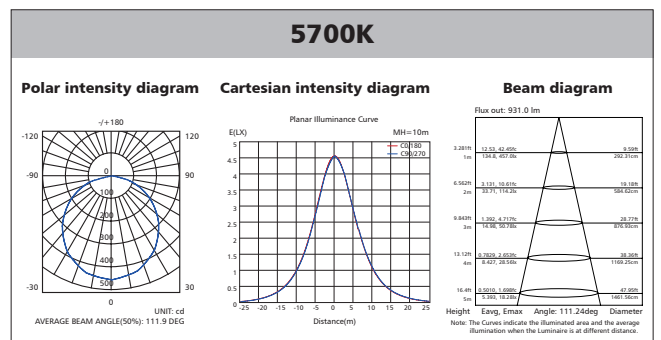
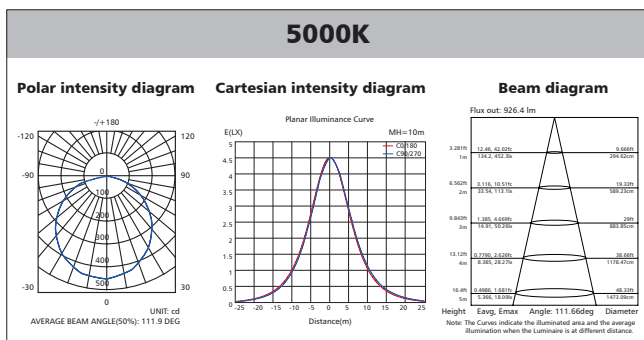
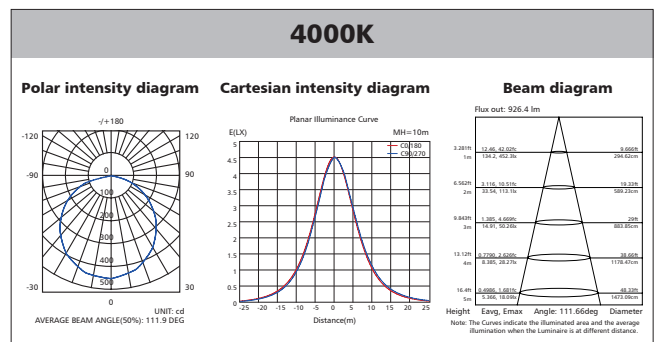
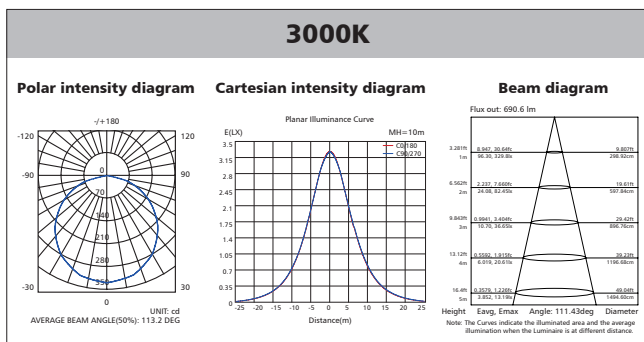

Polar Diagram Comparison

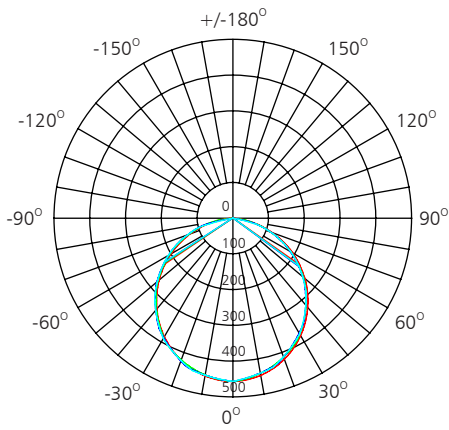

UNIT: cd

- C0/180, 111.2 deg
- C30/210, 110.9 deg
- C60/240, 111.9 deg
- C90/270, 111.3 deg

AVERAGE BEAM ANGLE (50%): 111.1DEG



Driver lifetime & LED light decay rate

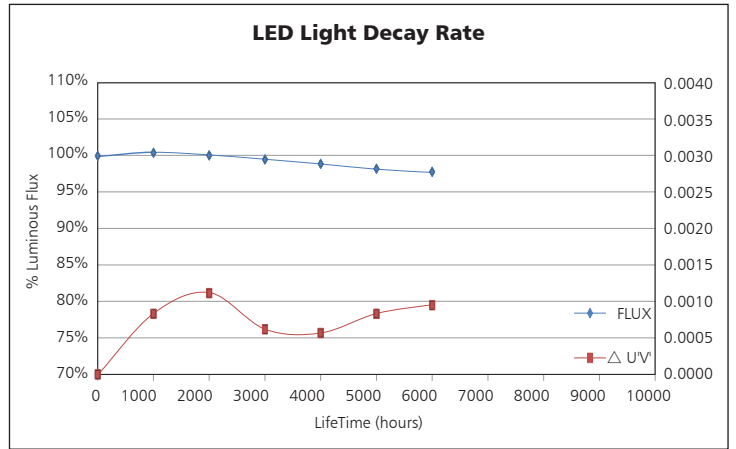
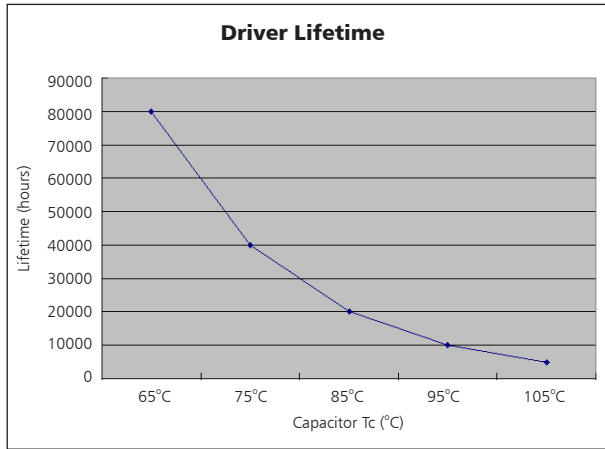

Temperature

- The testing is operated at 25°C
- The lifetime of capacitor, minimum of 5,000 hours if operated at 105°C, will be doubled whenever the temperature drops 10°C
- The highest withstand temperature of IC, MOS could be 120°C
- The highest withstand temperature of LED junction temperature is 150°C

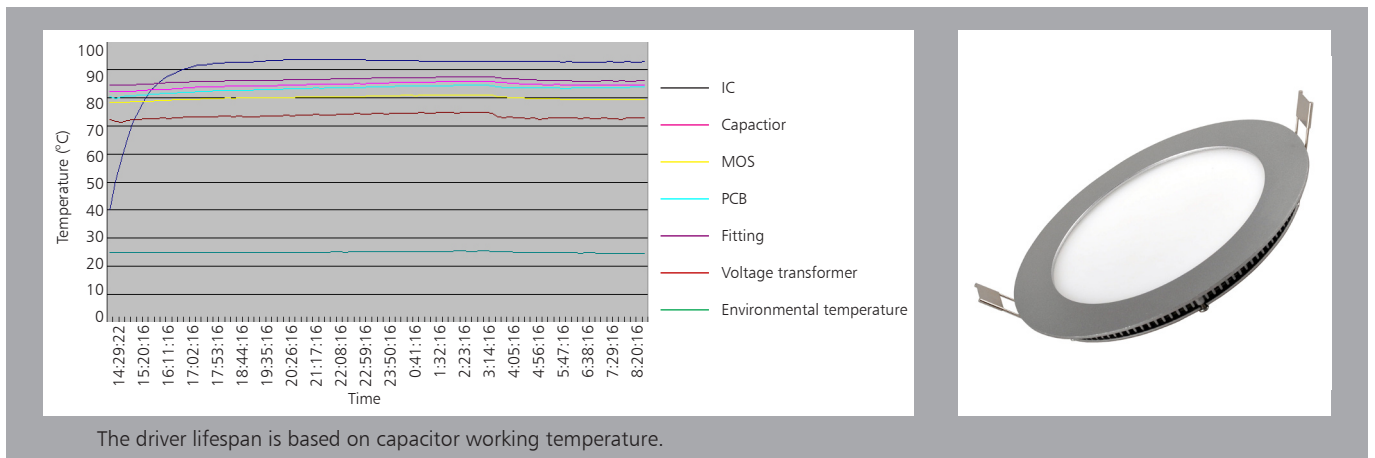

The driver lifespan is based on capacitor working temperature.



Installation

Install requirements	
A-gap above the fitting	25mm
B-gap to the building material	25mm
C-gap to the thermal insulation	25mm

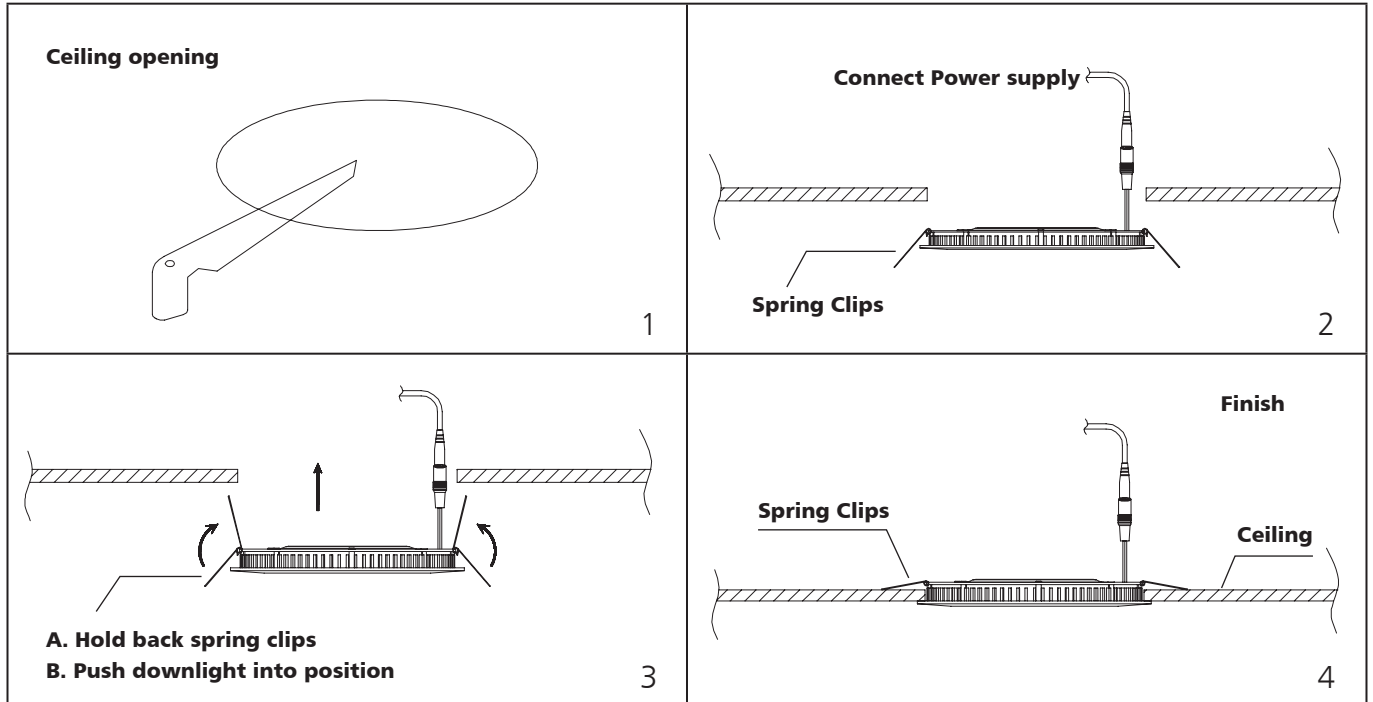
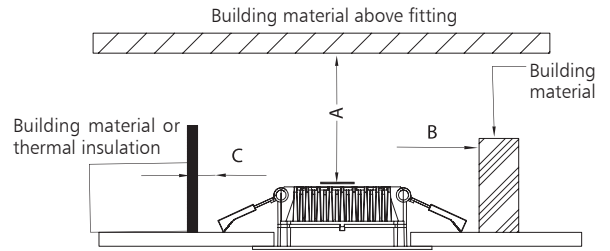

Packaging Information

	SIZE(CM)	N.W/pc (KGS)	G.W.(KGS)	Q'TY(PCS)
Carton	52.5*30*27	0.75	9.7	10

	CTNS	Q'TY(PCS)	VOLUME(CBM)
20" standard container	640	6400	28
40" standard container	1280	12800	56

