

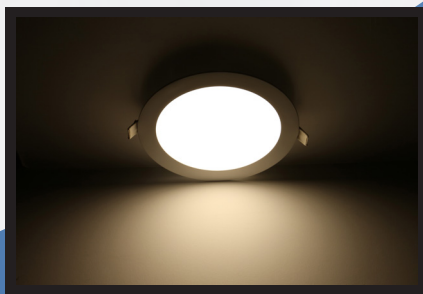

UPSHINE®



Technical Application  
Guide for UP-SHINE  
LED Panel Light  
UP-PL2019-10W-P3



# Introduction

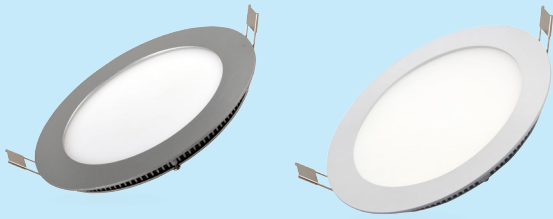

## Slide Switch Function

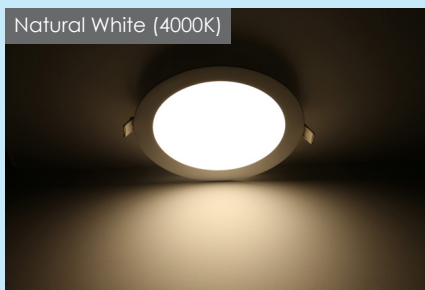
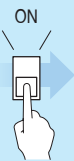

Super Slim round panel provided in full diameter, adopting SMD led chip. External driver comes with triac dim, it shares great popularity by perfect dimming range and great compatibility with worldwide dimmers. The ultra slim profile fits perfectly for all working places.

- Up to 80% energy saving compared to standard CFL
- Long lifetime of 40,000 hours
- Triac dim
- 120° wide beam angle
- 190mm cutout
- CCT: 3000K 4000K 5700K
- No UV/IR light
- Environment friendly, without Mercury or any other hazardous substances

## Application notes

- IP20 for indoor use only
- Professional electrician for installation only
- Switch off before installation
- Do not touch when in use
- Keep away from hot steam and corrosive gas

## Application Areas

Widely used for various commercial lighting and residential lighting applications, such as offices, shopping mall, hotel, restaurant, hospital, home lighting etc.

## Certificates

CE RoHS SAA

# Product Information

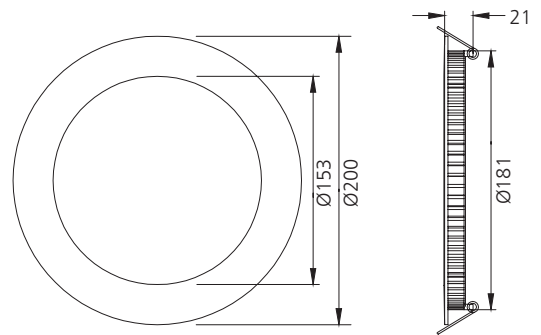

## Technical Specifications

Model	Voltage	Power	Power Factor	Lumen (±5%)	CCT	Beam angle	Lifespan	CRI	Dimmable	Dimension
UP-PL2019-10W-P3	AC230V	10W	≥0.9	620	3000K	120°	40000h	≥80	Yes	Ø200*21mm cutout 190mm
				670	4000K					
				720	5700K					

## Driver data Sheet

Driver data	DIM
Input rated Voltage	AC230V
Frequency	50HZ
Input Voltage	AC200-240V
Efficiency	≥75%
Total load Wattage	10W±1W
Power Factor	≥0.9
Rated input current	≤0.06A
Full load output Voltage	DC29-33V
Rated output current	250mA
Output current range	250mA±5%
Power tolerance	±5%
Current output tolerance	±5%
Dimming range	8%-100%
Dimmer	Triac dimmers
Short circuit protection	PASS
Over voltage protection	PASS
Over temperature protection	PASS
Withstand voltage	AC3750V

## Fixture Compatibility

Rated Wattage	Electrical Classification	Ingress Protection	Operating Temp	Operating Humidity	Storage Temp
10W	II	IP20	-20°C~45°C	0~90%	-20°C~65°C

# Spectral Distribution

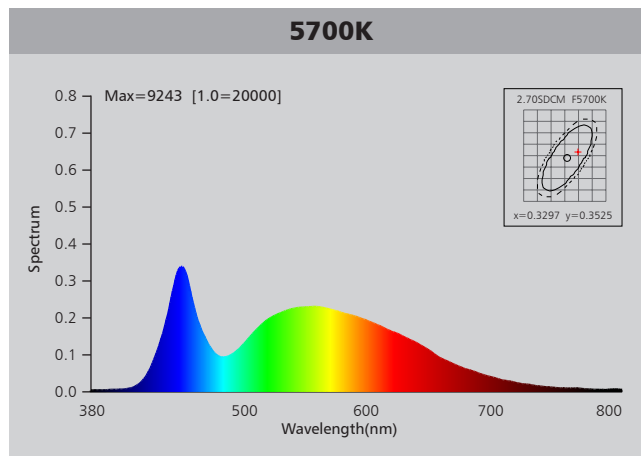
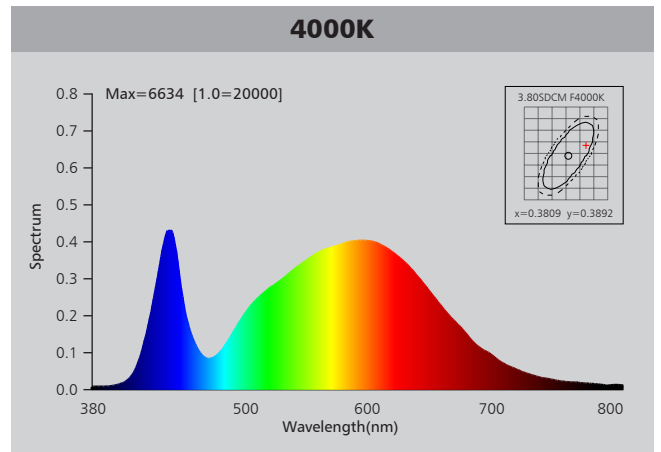
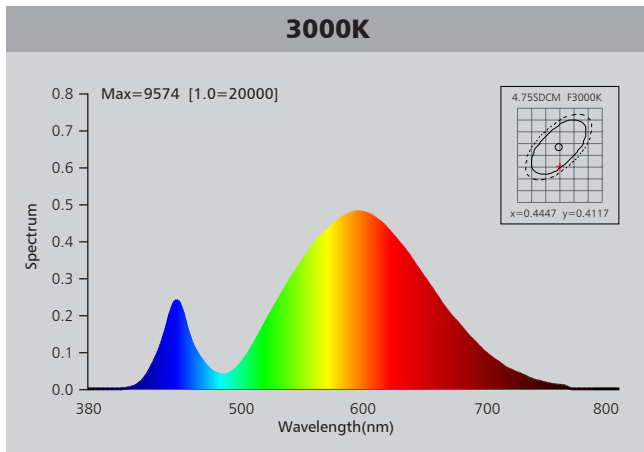

# Photometric Diagram

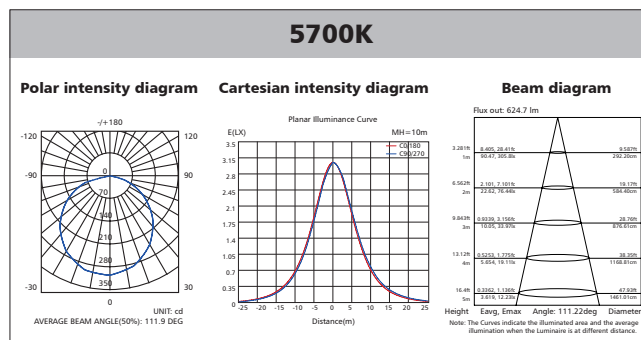
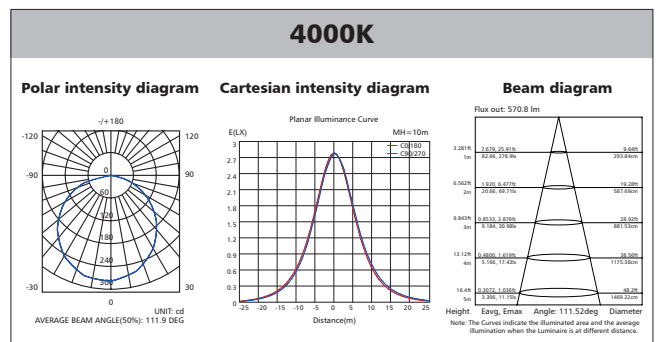
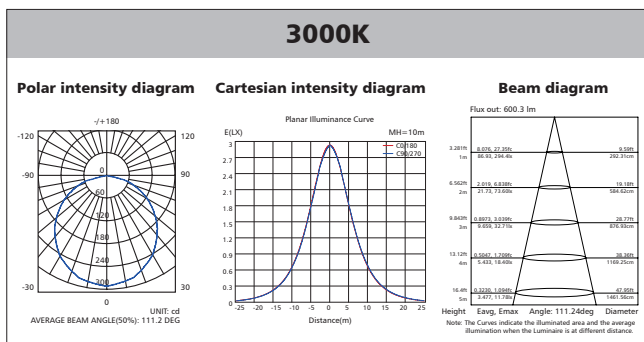

## Polar Diagram Comparison

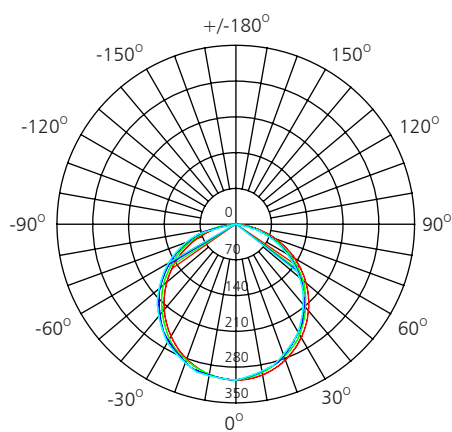

UNIT: cd

- C0/180, 111.2 deg
- C30/210, 111.2 deg
- C60/240, 111.9 deg
- C90/270, 112.3 deg

AVERAGE BEAM ANGLE (50%): 111.6DEG



## Driver lifetime & LED light decay rate

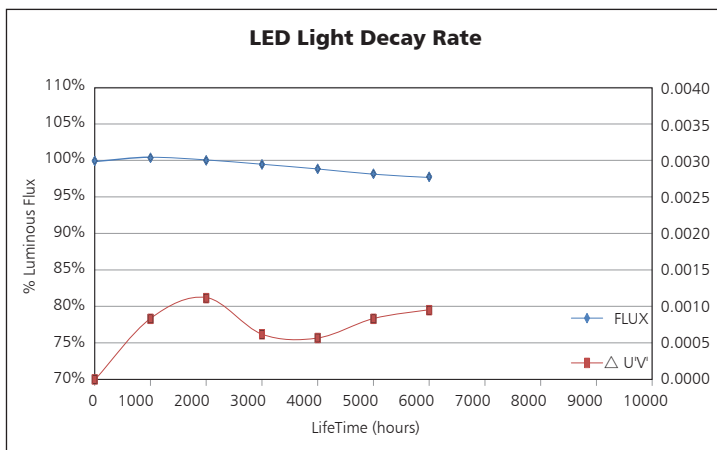
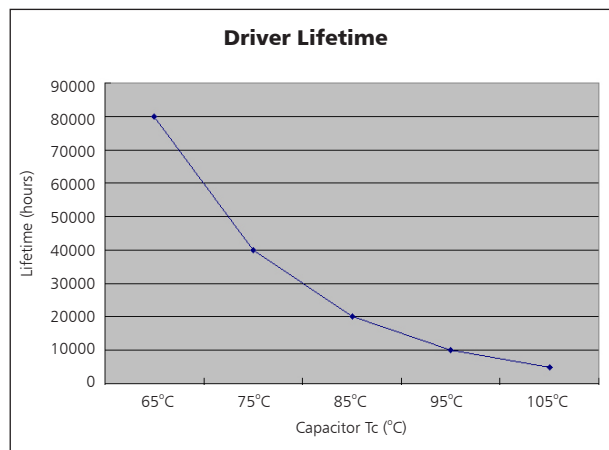

## Temperature

- The testing is operated at 25°C
- The lifetime of capacitor, minimum of 5,000 hours if operated at 105°C, will be doubled whenever the temperature drops 10°C
- The highest withstand temperature of IC, MOS could be 120°C
- The highest withstand temperature of LED junction temperature is 150°C

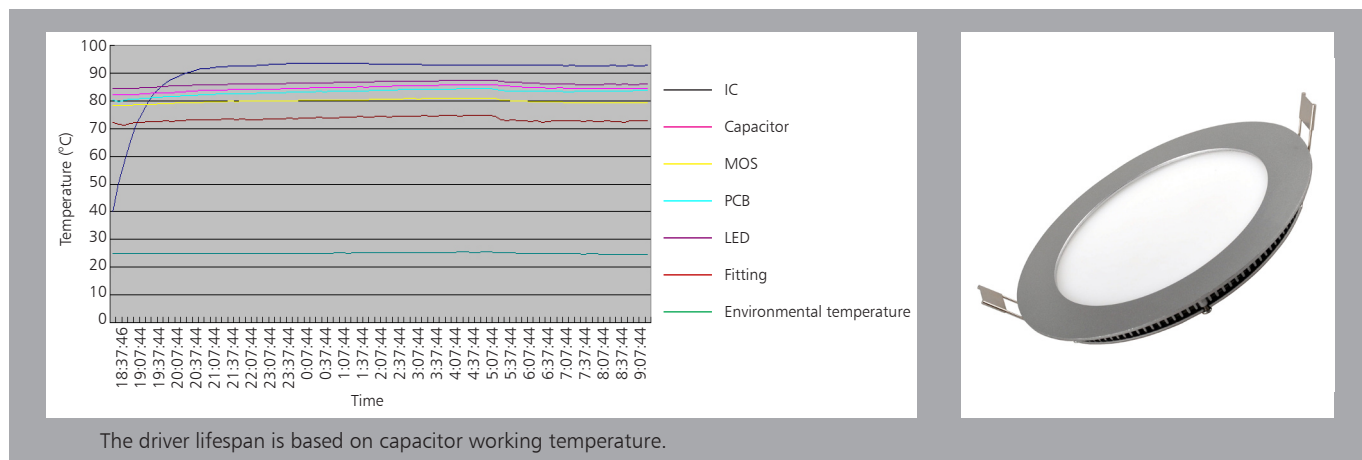

The driver lifespan is based on capacitor working temperature.

# Installation

Install requirements	
A-gap above the fitting	25mm
B-gap to the building material	25mm
C-gap to the thermal insulation	25mm

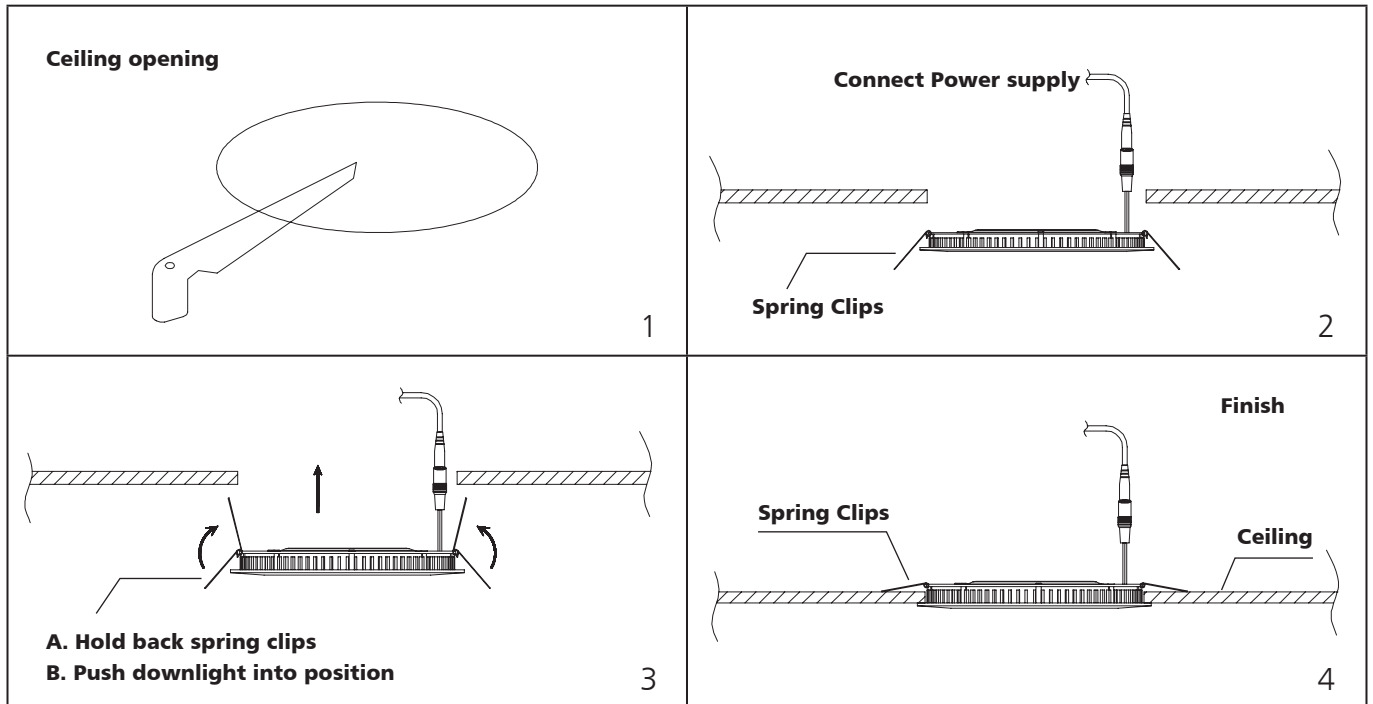
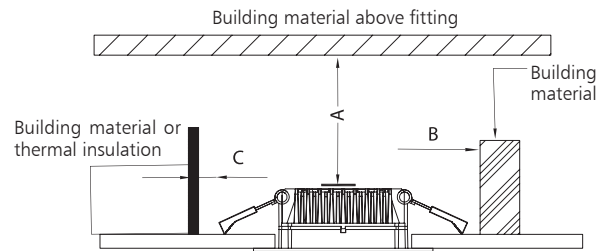

# Packaging Information

	SIZE(CM)	N.W/pc (KGS)	G.W.(KGS)	Q'TY(PCS)
Carton	52.5*25.5*22.5	0.55	7.0	10

	CTNS	Q'TY(PCS)	VOLUME(CBM)
20" standard container	899	9520	28
40" standard container	1798	19040	56

