



UPSHINE®



Technical Application
Guide for UP-SHINE
LED Panel Light
UP-PL30120-45W-L

Introduction

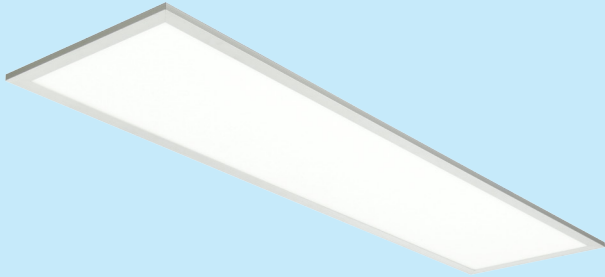

Double-sided panel light is designed for special use with decorative effect. 70% light downward and 30% light upward, it is only suitable for suspended installations. Adopts high lumen SMD, CRI >80, top branded driver comes with dimmable function. High quality LGP creates extremely uniform light. It is an ideal choice for commercial and residential applications.

- Up to 80% energy saving compared to standard CFL
- Long lifetime of 40,000 hours
- Triac dim, 0-10V dim, DALI dim
- 270° wide beam angle
- CCT: 3000K 4000K
5000K 5700K
- No UV/IR light
- Environment friendly, without Mercury or any other hazardous substances

Application notes

- IP40 for indoor use only
- Professional electrician for installation only
- Switch off before installation
- Do not touch when in use
- Keep away from hot steam and corrosive gas

Application Areas

Office & school lighting: office room, meeting room, class room etc.

Commercial lighting: shopping mall, super market, retailer shops etc.

Other situations: hospital, laboratory, dust-free workshop etc.

Certificates

CE RoHS SAA



Product Information

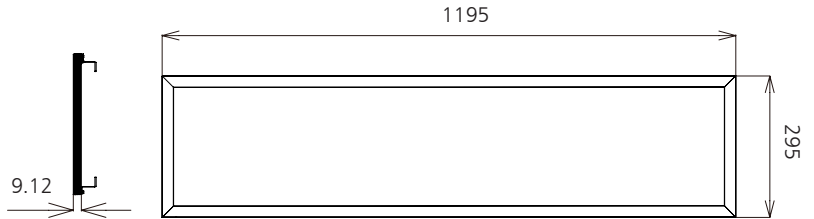
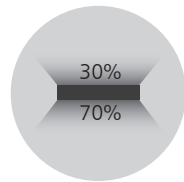

Technical Specifications

Model	Voltage	Power	Power Factor	Lumen (±5%)	Beam angle	CCT	Lifespan	CRI	Dimmable	Dimension
UP-PL30120-45W-L	AC100-240V	45W	≥0.9	2850	270°	3000K	40000h	≥80	No	1195*295*9.12mm
UP-PL30120-45W-L	AC100-240V	45W	≥0.9	3000	270°	4000K	40000h	≥80	No	1195*295*9.12mm
UP-PL30120-45W-L	AC100-240V	45W	≥0.9	3050	270°	5000K	40000h	≥80	No	1195*295*9.12mm
UP-PL30120-45W-L	AC100-240V	45W	≥0.9	3100	270°	5700K	40000h	≥80	No	1195*295*9.12mm
UP-PL30120-45WD-L	AC230V	45W	≥0.9	2700	270°	3000K	40000h	≥80	Yes	1195*295*9.12mm
UP-PL30120-45WD-L	AC230V	45W	≥0.9	2750	270°	4000K	40000h	≥80	Yes	1195*295*9.12mm
UP-PL30120-45WD-L	AC230V	45W	≥0.9	2780	270°	5000K	40000h	≥80	Yes	1195*295*9.12mm
UP-PL30120-45WD-L	AC230V	45W	≥0.9	2790	270°	5700K	40000h	≥80	Yes	1195*295*9.12mm

Driver data Sheet

Driver data	DIM	Non-dim
Input rated Voltage	AC230V	AC100-240V
Frequency	50Hz	50/60Hz
Input Voltage	AC200-240V	AC85-265V
Efficiency	≥83%	≥86%
Total load Wattage	45W±5%	45W±5%
Power Factor	≥0.9	≥0.9
Rated input current	≤0.22A	≤0.5A
Full load output Voltage	DC35-38V	DC35-38V
Rated output current	1000mA	1050mA
Output current range	1000mA±5%	1050mA±5%
Power tolerance	±5%	±5%
Current output tolerance	±5%	±5%
Dimming range	8%-100%	—
Dimmer	Triac dimmers	—
Short circuit protection	PASS	PASS
Over voltage protection	PASS	PASS
Over temperature protection	PASS	PASS
Withstand voltage	AC3750V	AC3750V

Fixture Compatibility

Rated Wattage	Electrical Classification	Ingress Protection	Operating Temp	Operating Humidity	Storage Temp
45W	II	IP40	-20°C~45°C	0~90%	-20°C~65°C

Spectral Distribution

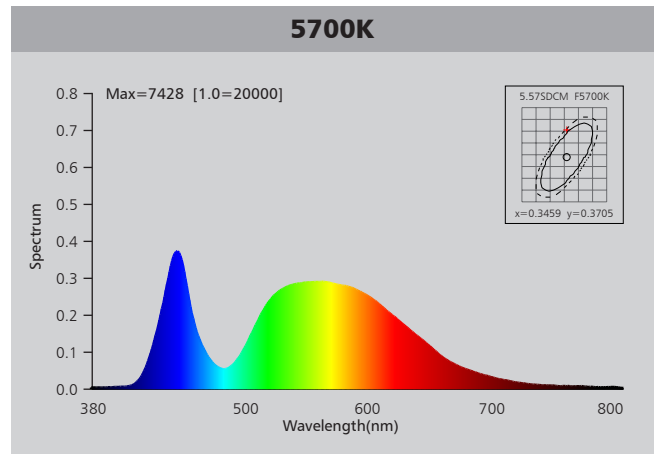
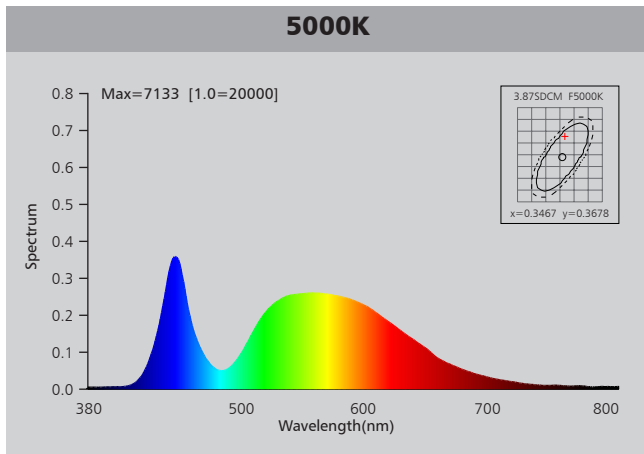
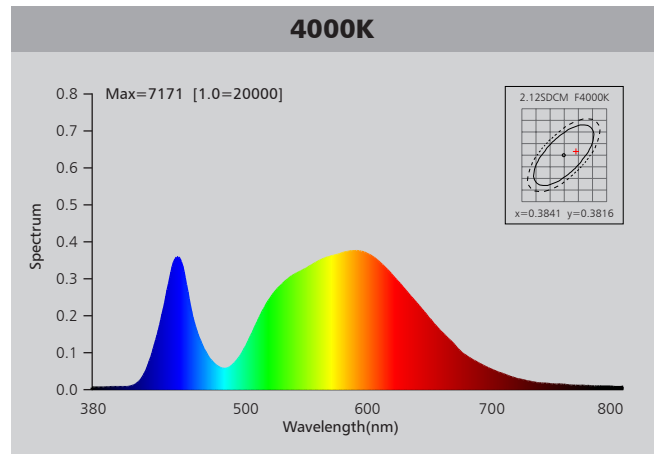
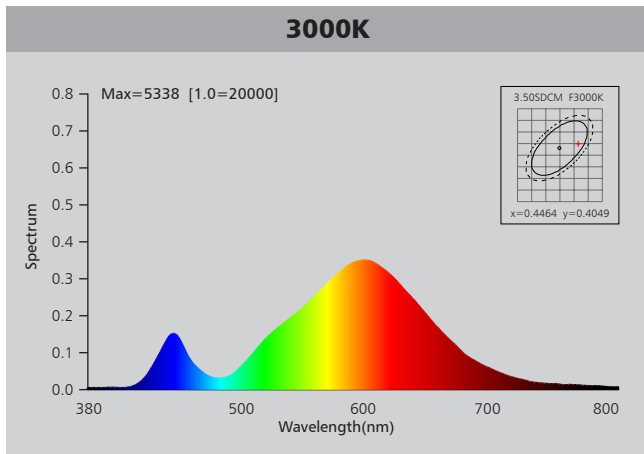

Photometric Diagram

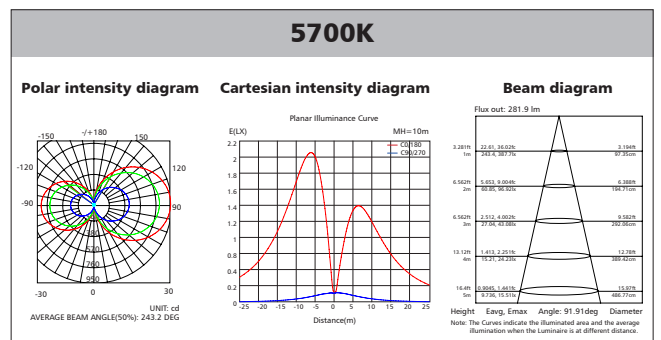
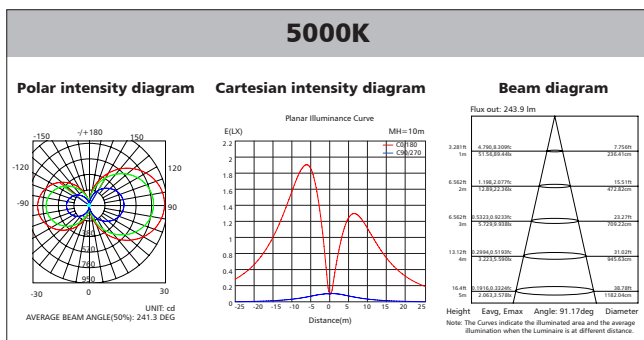
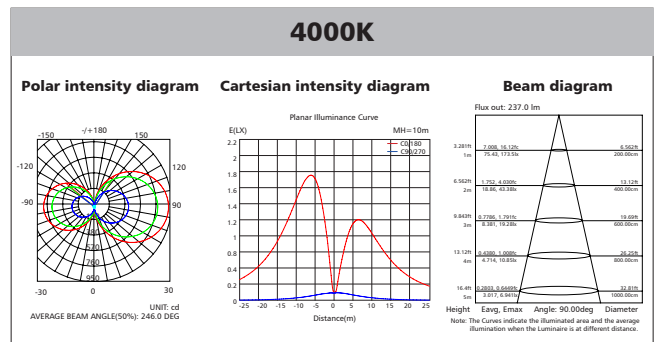
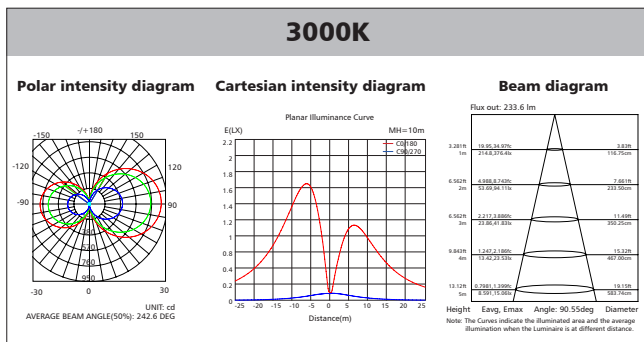

Polar Diagram Comparison

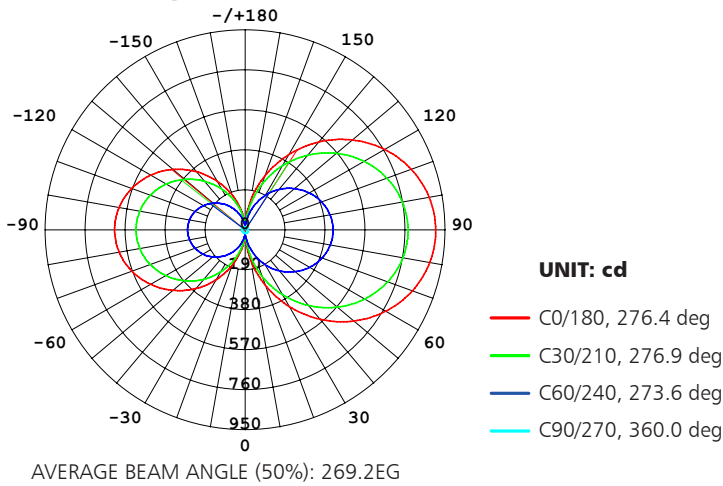

Driver lifetime & LED light decay rate

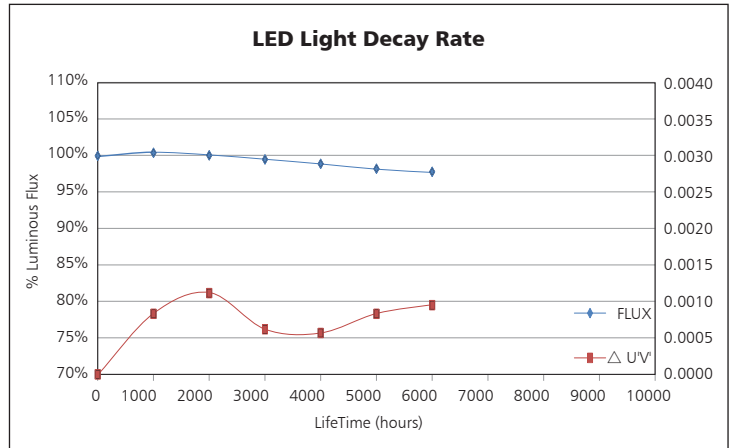
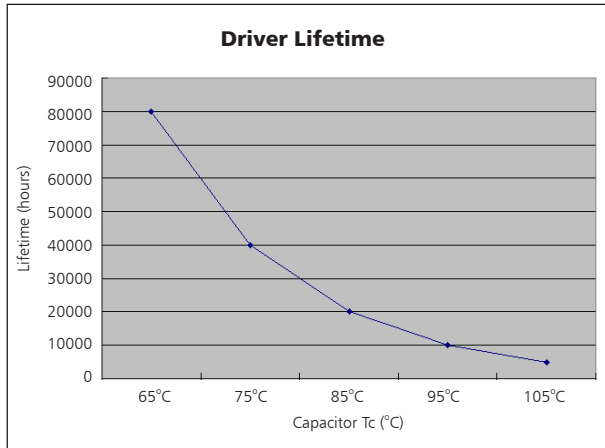

Temperature

- The testing is operated at 25°C
- The lifetime of capacitor, minimum of 5,000 hours if operated at 105°C, will be doubled whenever the temperature drops 10°C
- The highest withstand temperature of IC, MOS could be 120°C
- The highest withstand temperature of LED junction temperature is 150°C

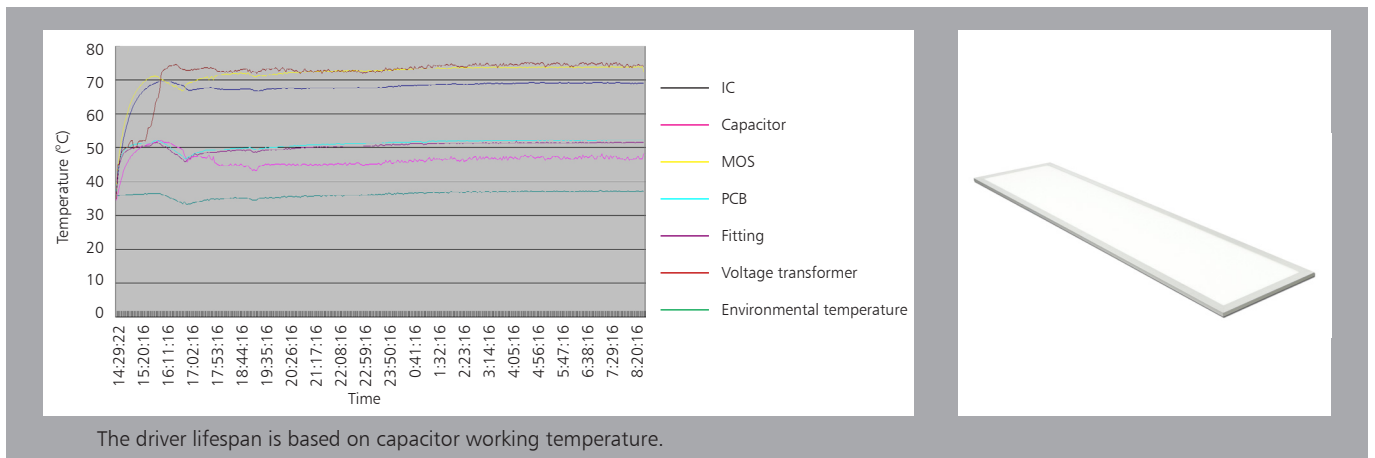

Installation

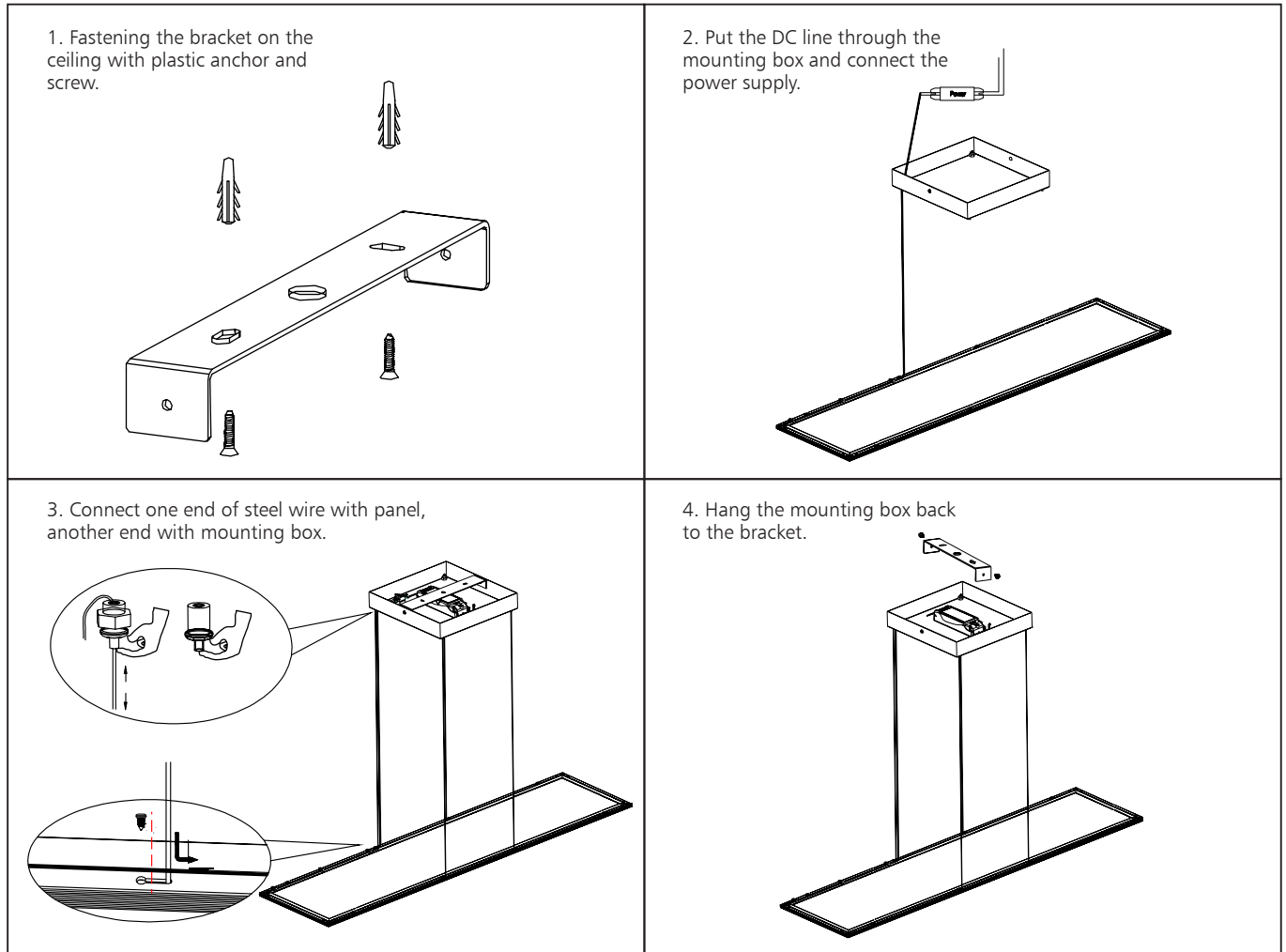

Packaging Information

	SIZE(CM)	N.W/pc (KGS)	G.W.(KGS)	Q'TY(PCs)
Carton	156.5*35*38	4.5	29.5	5

	CTNS	Q'TY(PCs)	VOLUME(CBM)
20" standard container	130	650	28
40" standard container	260	1300	56

