



UPSHINE[®]



Technical Application Guide for UP SHINE LED Panel Light

UP-PL30120-45W-AN-W



Introduction

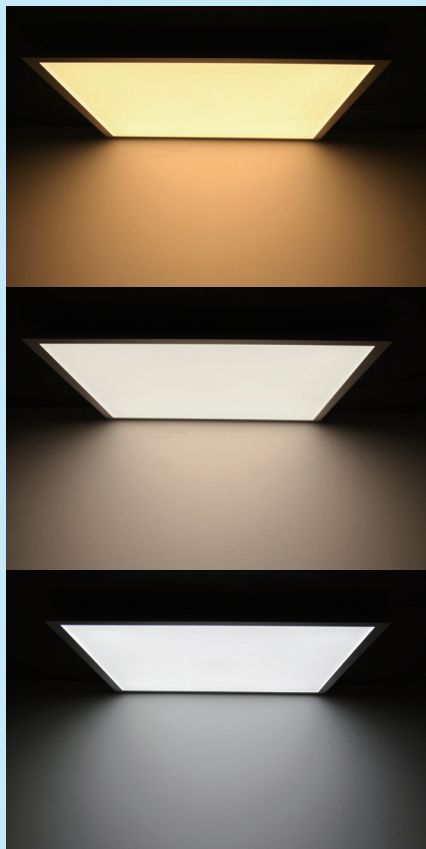

2.4G WiFi wireless led panel light comes with a 2.4G remote controller and it can also be conveniently used to be operated through regular switches or mobile phone. You can have complete home lighting control right in your pocket. After installing the panel light, download a free application to your smart phone and you are ready to control lights with mobile phone. You may change the color to set an appropriate mood and to match the room decor.

- Up to 80% energy saving compared to standard CFL
- Long lifetime of 50,000 hours (25°C)
- WIFI(2.4G)
- No UV/IR light
- Environment friendly, without Mercury or any other hazardous substances

Application notes

- IP40 for indoor use only
- Professional electrician for installation only
- Switch off before installation
- Do not touch when in use
- Keep away from hot steam and corrosive gas

Application Areas

Office & school lighting: office room, meeting room, class room etc.

Commercial lighting: shopping mall, super market, retailer shops etc.

Other situations: hospital, laboratory, dust-free workshop etc.

Certificates

CE **RoHS**



QR code for IOS
(APP STORE)



QR code for Android
(GooglePlay)

2.4G&Wifi Intelligent Control

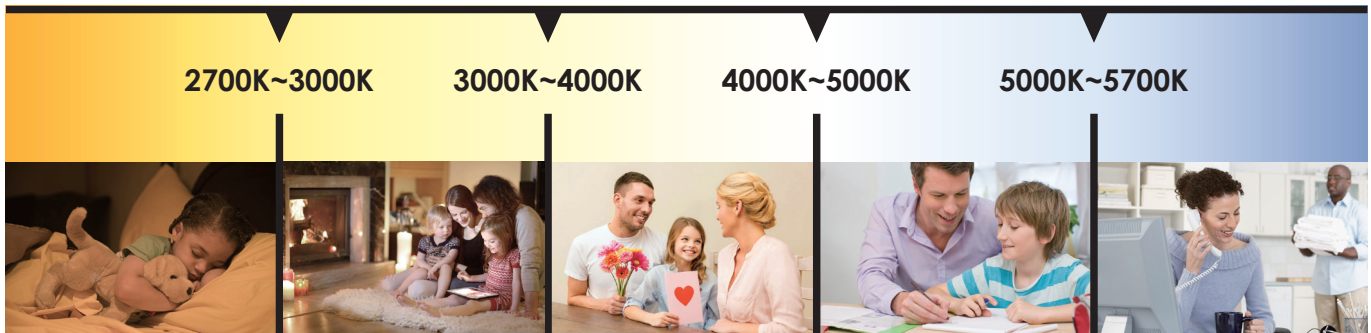

2.4G Remote controller



WiFi Box (Mobile App)



Color Changeable



Dimmable

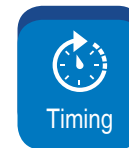

Timing

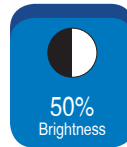

50% Brightness



Night Lamp

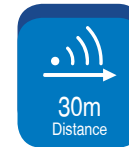

30m Distance



2700K~5700K Changeable

Creating fantastic atmosphere by flexible CCT changing between warm white, natural white and day light, the color changing items are controlled by remote controller, wall touch switch or smart phone APP.



8%~100% Dimmable

Dimmable from 8%~100% brightness with timing and night lamp function, diversified scene setting, creating a humanized smart control system.



Product Information

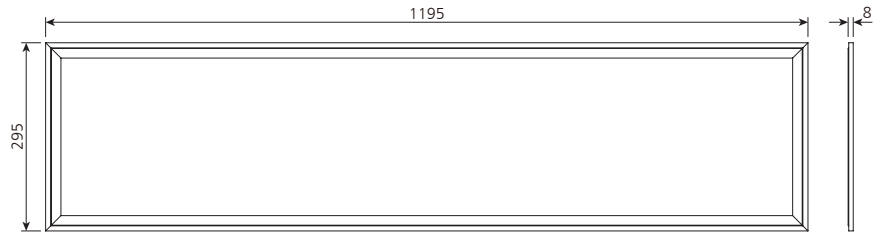

Technical Specifications

Model	Voltage	Power	Power Factor	Lumen (±5%)	Beam angle	CCT	Lifespan	CRI	Dimmable	Dimension
UP-PL30120-45W-AN-W	AC100-240V	45W	≥0.9	3330 ⋮ 4050 ⋮ 3400	120°	2700K ⋮ 4000K ⋮ 5700K	40000h	≥80	Yes	1195*295*8mm

Driver data Sheet

Driver data	DIM
Input rated Voltage	AC100-240V
Frequency	50/60Hz
Input Voltage	AC85-265V
Efficiency	≥85%
Total load Wattage	45W±5%
Power Factor	≥0.95
Rated input current	≤0.6A
Full load output Voltage	DC24-38V
Rated output current	1050mA
Output current range	1050mA±5%
Power tolerance	±5%
Current output tolerance	±3%
Dimming range	8%-100%
Short circuit protection	PASS
Over voltage protection	PASS
Over temperature protection	PASS
Withstand voltage	AC3750V

Fixture Compatibility

Rated Wattage	Electrical Classification	Ingress Protection (IP)	Operating Temp	Operating Humidity	Storage Temp
45W	II	IP40	-20°C~45°C	0~90%	-20°C~65°C

Spectral Distribution

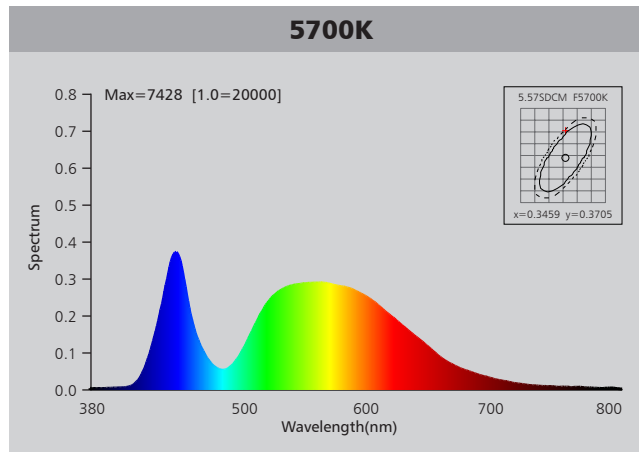
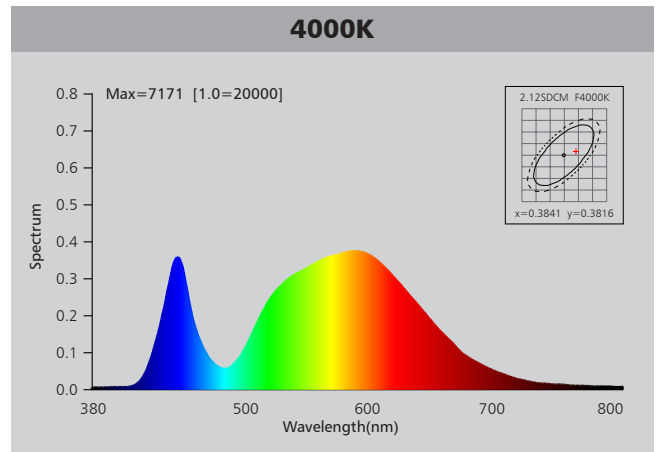
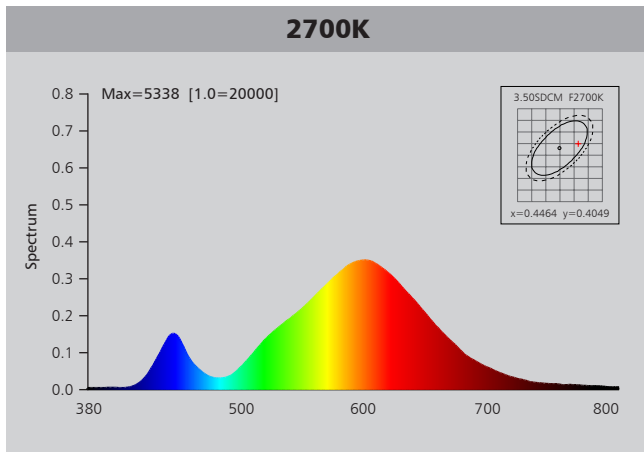

Photometric Diagram

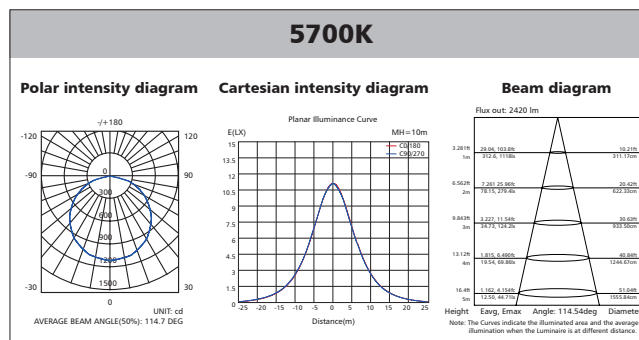
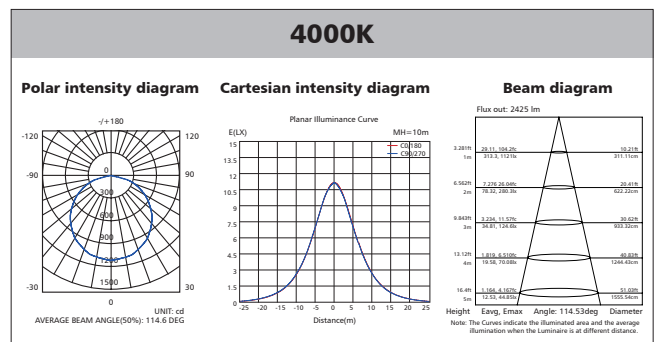
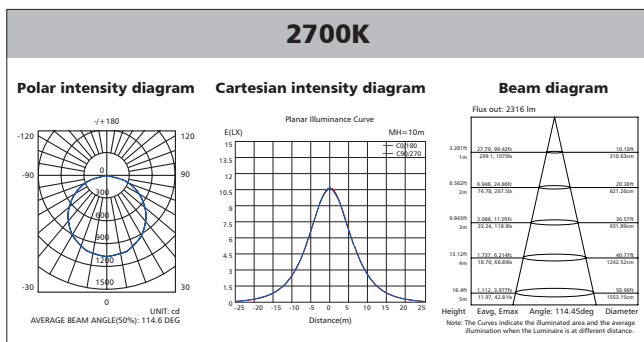

Polar Diagram Comparison

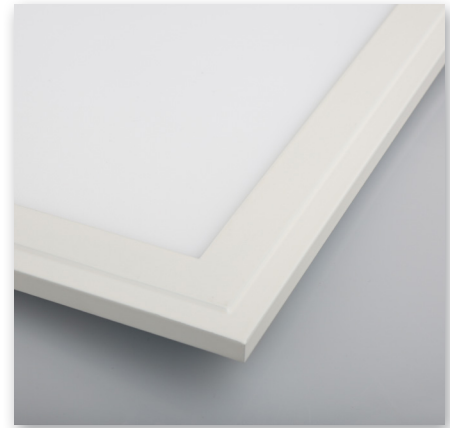
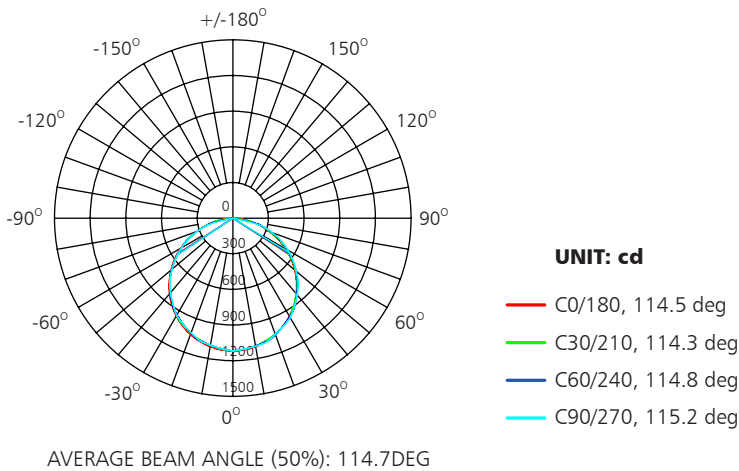

Driver lifetime & LED light decay rate

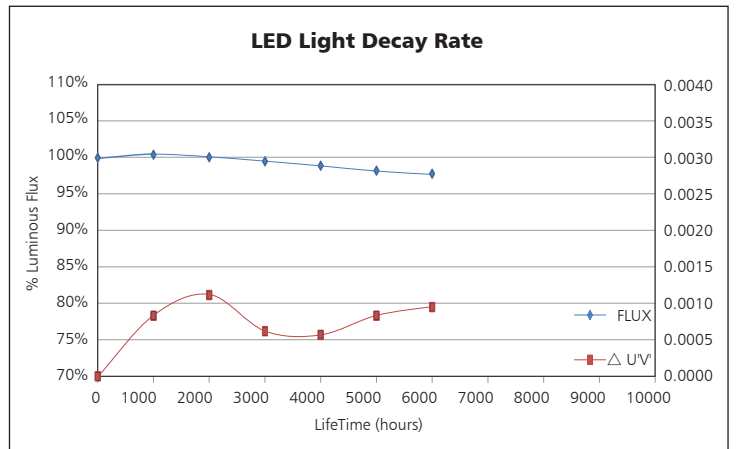
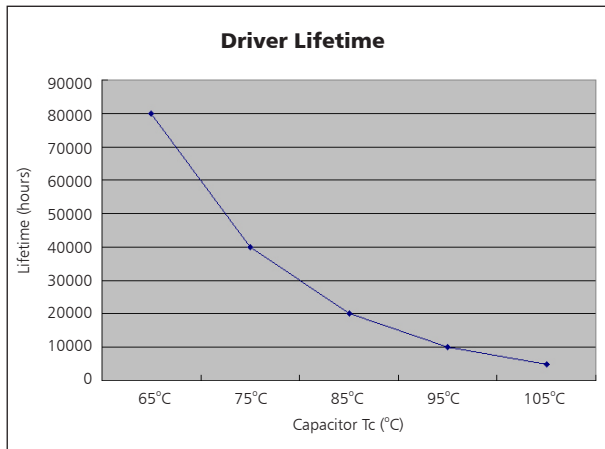

Temperature

- The testing is operated at 25°C
- The lifetime of capacitor, minimum of 5,000 hours if operated at 105°C, will be doubled whenever the temperature drops 10°C
- The highest withstand temperature of IC, MOS could be 120°C
- The highest withstand temperature of LED junction temperature is 150°C

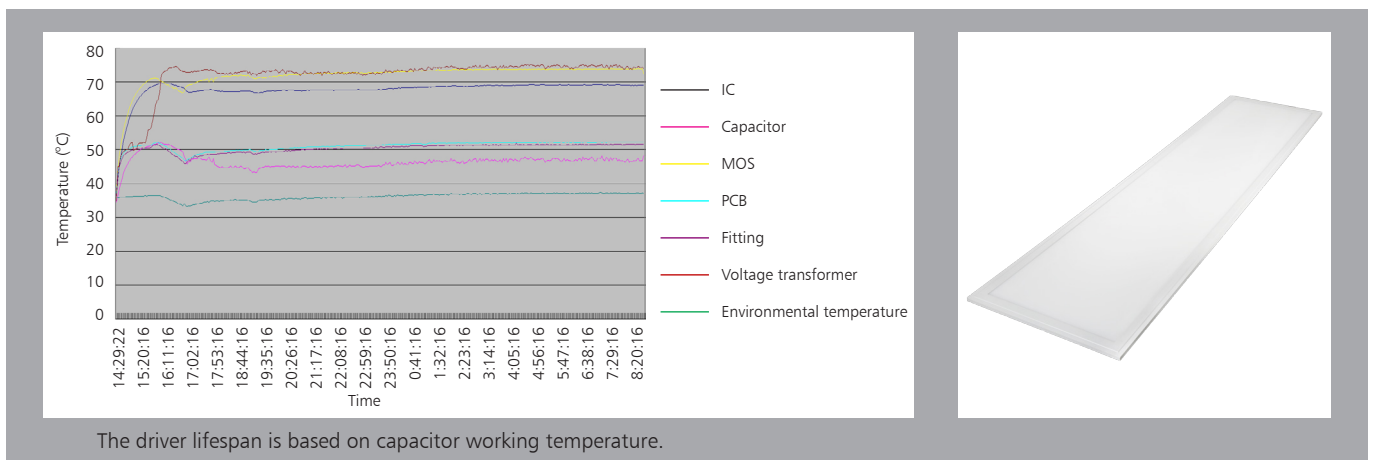

Installation

1. Recessed into ceiling

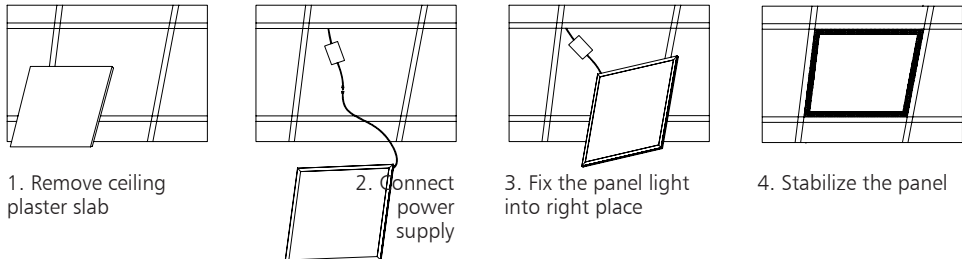

1. Remove ceiling plaster slab
2. Connect power supply
3. Fix the panel light into right place
4. Stabilize the panel

2. Suspending

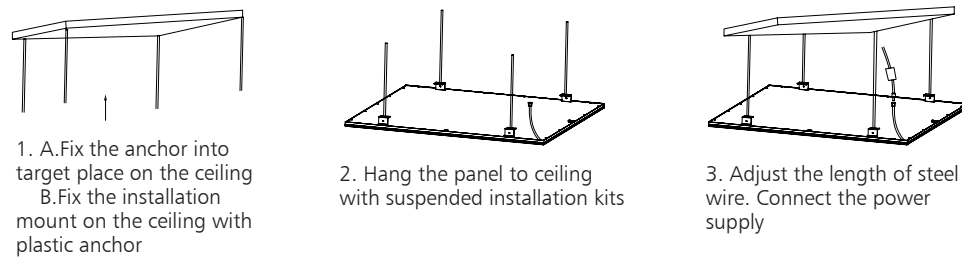

1. A. Fix the anchor into target place on the ceiling
B. Fix the installation mount on the ceiling with plastic anchor
2. Hang the panel to ceiling with suspended installation kits
3. Adjust the length of steel wire. Connect the power supply

3. Surface mounted

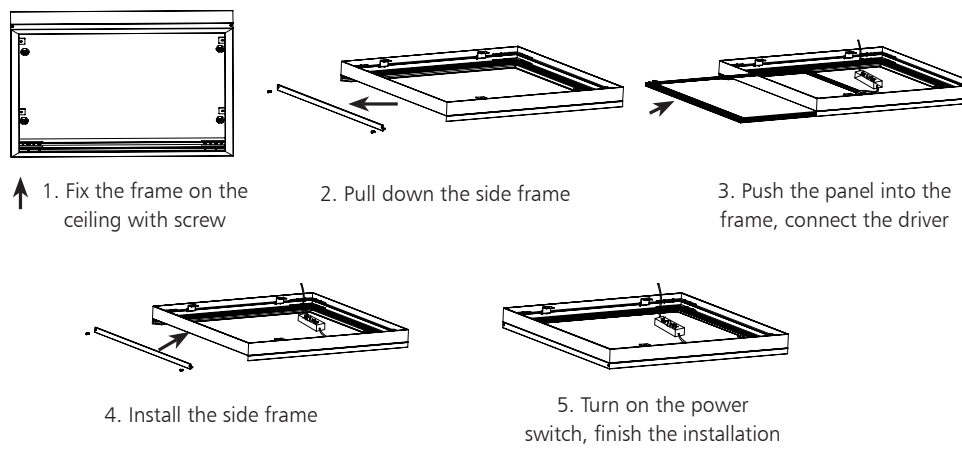

1. Fix the frame on the ceiling with screw
2. Pull down the side frame
3. Push the panel into the frame, connect the driver
4. Install the side frame
5. Turn on the power switch, finish the installation

Packaging Information

	SIZE(CM)	N.W/pc (KGS)	G.W.(KGS)	Q'TY(PCS)
Carton	130*22.5*36	2.7	19.5	5

	CTNS	Q'TY(PCS)	VOLUME(CBM)
20" standard container	260	1300	28
40" standard container	520	2600	56

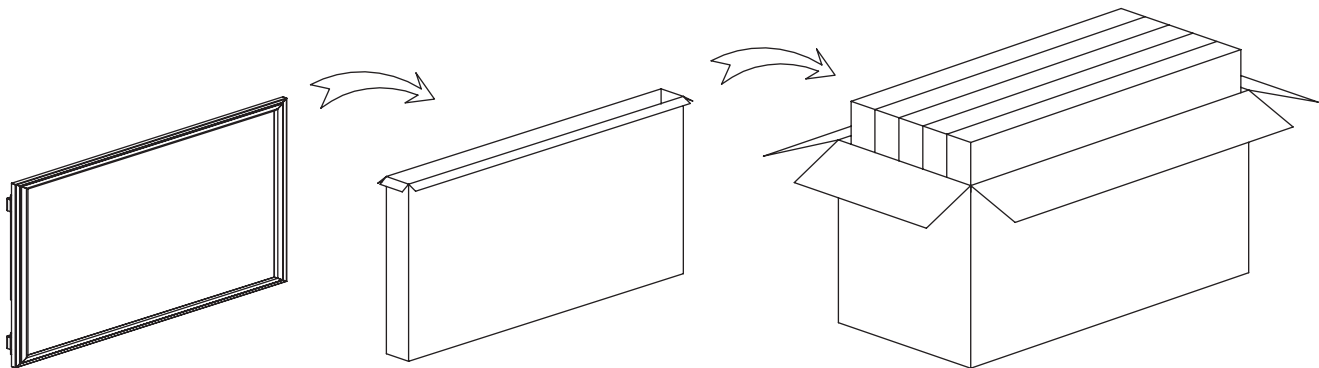

Note: If the diffused material LGP is constructed from quality PS material, while discoloration of LED panel is easily generated with exposure to sunlight/UV. In general installation area, places without sunlight/UV, PS is strong enough to support. However, sunlight/UV can cause discoloration, under this circumstance, we would recommend the use of LED panel made of PMMA material. Please note warranty does not cover discoloration of diffused material.