



UPSHINE®



Technical Application
Guide for UP SHINE
LED Panel Light

UP-PL6262-40W-AN

Introduction



Up-shine LED panel adopts high lumen SMD LED with CRI >80. Top branded driver comes with triac dim, 0-10V dim and DALI dim, it has perfect dimming range and shares great compatibility with worldwide famous brand dimmers.

The ultra slim profile fits seamlessly into any work place. It is available in various installation ways: embedded into ceiling, suspended with hanging wires, surface mounted in a concrete ceiling by using surface mounting frame.

- Up to 80% energy saving compared to standard CFL
- Long lifetime of 40,000 hours
- Triac dim, 0-10V dim, DALI dim
- 120° wide beam angle
- CCT: 3000K 4000K 5000K 5700K
- No UV/IR light
- Environment friendly, without Mercury or any other hazardous substances

Application notes

- IP40 for indoor use only
- Professional electrician for installation only
- Switch off before installation
- Do not touch when in use
- Keep away from hot steam and corrosive gas

Application Areas

Office & school lighting: office room, meeting room, class room etc.

Commercial lighting: shopping mall, super market, retailer shops etc.

Other situations: hospital, laboratory, dust-free workshop etc.

Certificates

CE RoHS SAA



Product Information

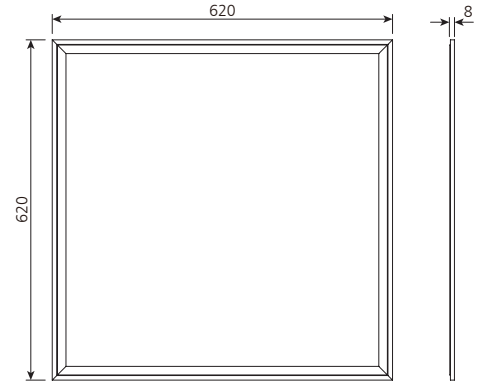

Technical Specifications

Model	Voltage	Power	Power Factor	Lumen (±5%)	CCT	Beam angle	Lifespan	CRI	Dimmable	Dimension
UP-PL6262-40W-AN	AC230V	40W	≥0.9	3650	3000K	120°	40000h	≥80	No	620*620*8mm
				3850	4000K					
				3900	5000K					
				3950	5700K					
UP-PL6262-40W-AN-D	AC230V	40W	≥0.9	3600	3000K	120°	40000h	≥80	Yes	620*620*8mm
				3800	4000K					
				3850	5000K					
				3900	5700K					

Driver data Sheet

Driver data	DIM	Non-dim
Input rated Voltage	AC230V	AC230V
Frequency	50Hz	50Hz
Input Voltage	AC200-240V	AC200-240V
Efficiency	≥83%	≥86%
Total load Wattage	40W±5%	40W±5%
Power Factor	≥0.9	≥0.9
Rated input current	≤0.23A	≤0.23A
Full load output Voltage	DC35-38V	DC35-38V
Rated output current	950mA	950mA
Output current range	950mA±5%	950mA±5%
Power tolerance	±5%	±5%
Current output tolerance	±5%	±5%
Dimming range	8%-100%	—
Dimmer	Triac dimmers	—
Short circuit protection	PASS	PASS
Over voltage protection	PASS	PASS
Over temperature protection	PASS	PASS
Withstand voltage	AC3750V	AC3750V

Fixture Compatibility

Rated Wattage	Electrical Classification	Ingress Protection	Operating Temp	Operating Humidity	Storage Temp
40W	II	IP40	-20°C~45°C	0~90%	-20°C~65°C

Spectral Distribution

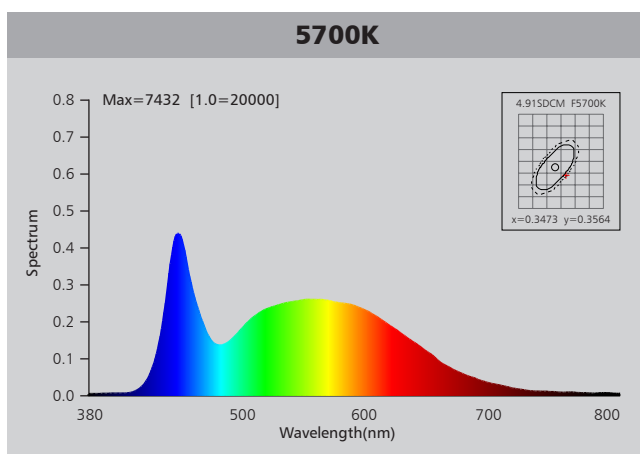
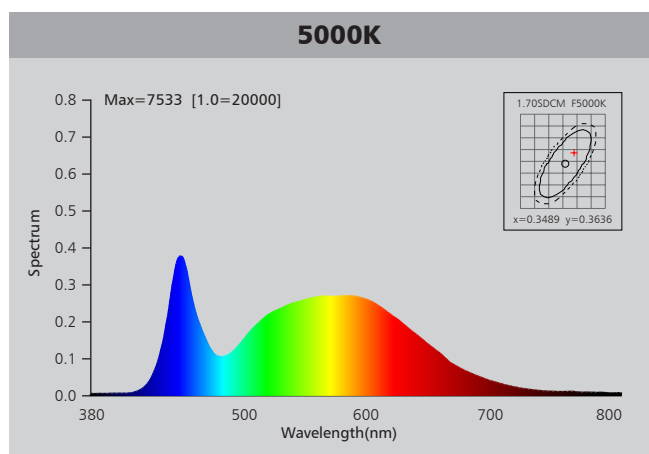
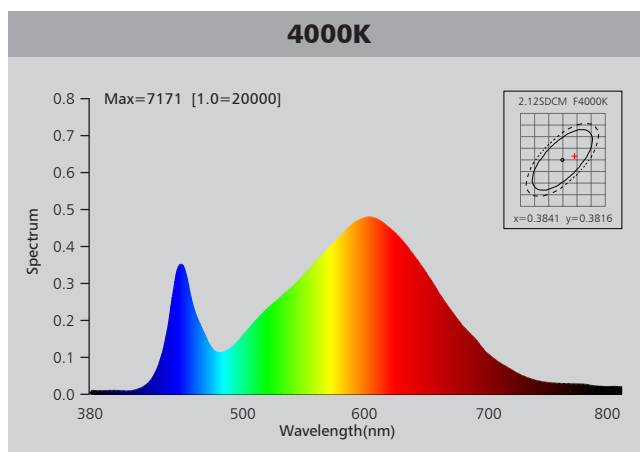
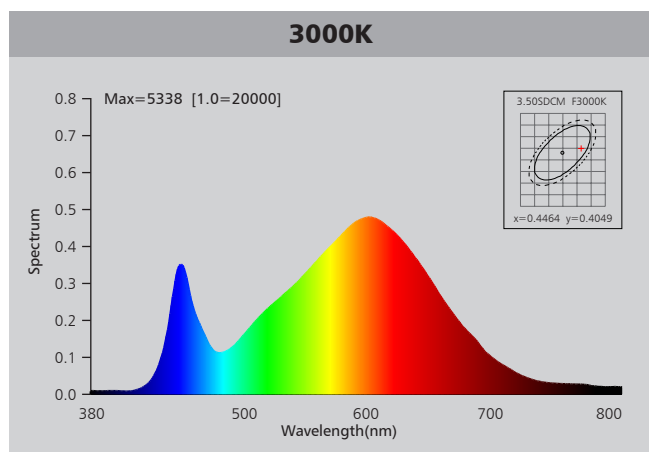

Photometric Diagram

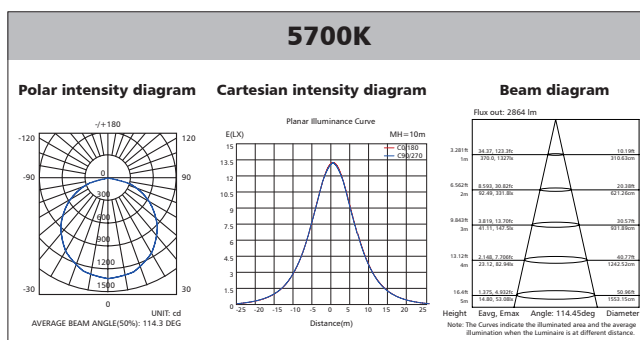
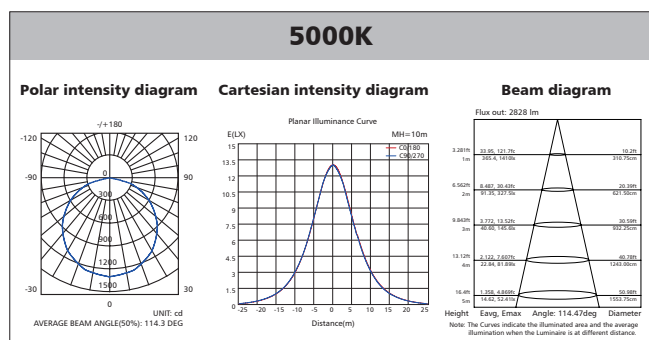
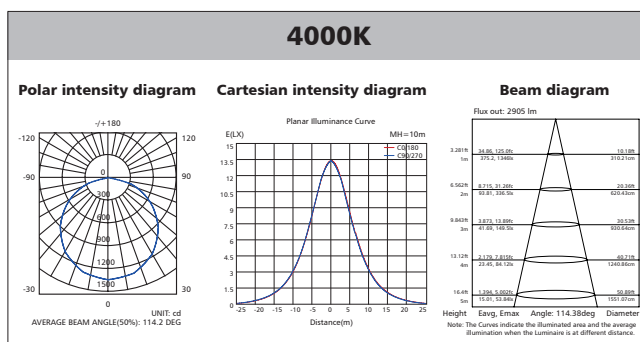
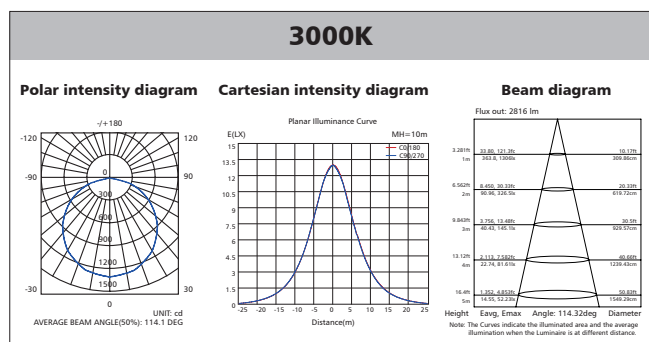

Polar Diagram Comparison

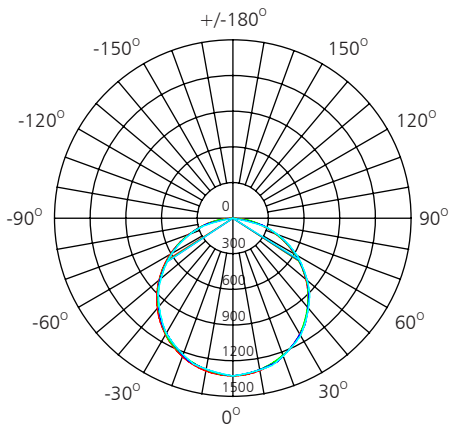

UNIT: cd

- C0/180, 114.5 deg
- C30/210, 114.0 deg
- C60/240, 114.1 deg
- C90/270, 114.4 deg

AVERAGE BEAM ANGLE (50%): 114.2DEG

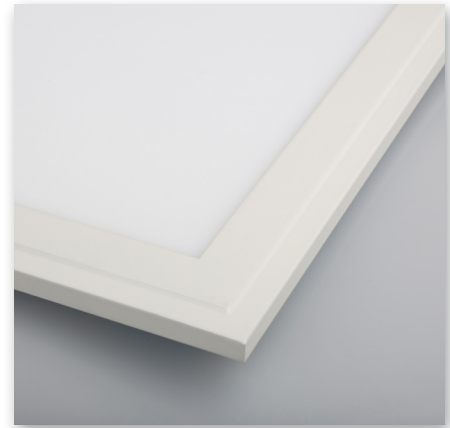

Driver lifetime & LED light decay rate

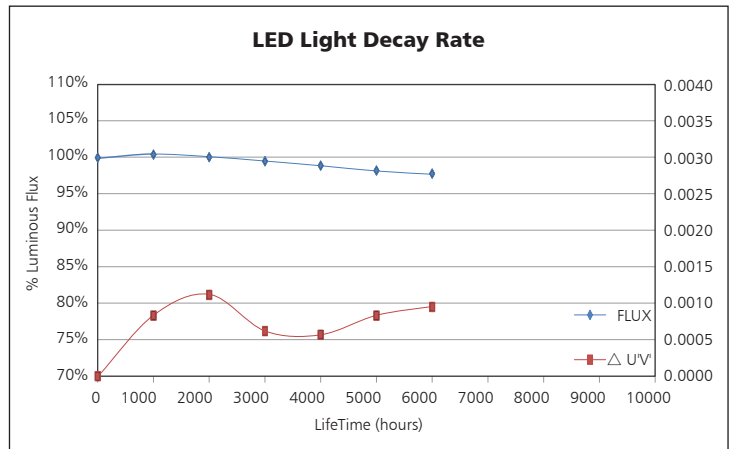
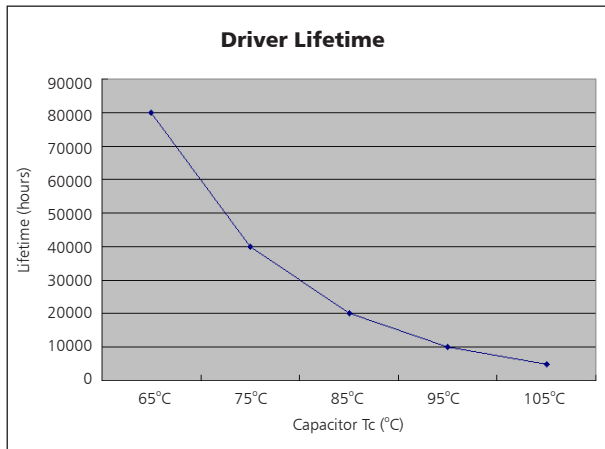

Temperature

- The testing is operated at 25°C
- The lifetime of capacitor, minimum of 5,000 hours if operated at 105°C, will be doubled whenever the temperature drops 10°C
- The highest withstand temperature of IC, MOS could be 120°C
- The highest withstand temperature of LED junction temperature is 150°C

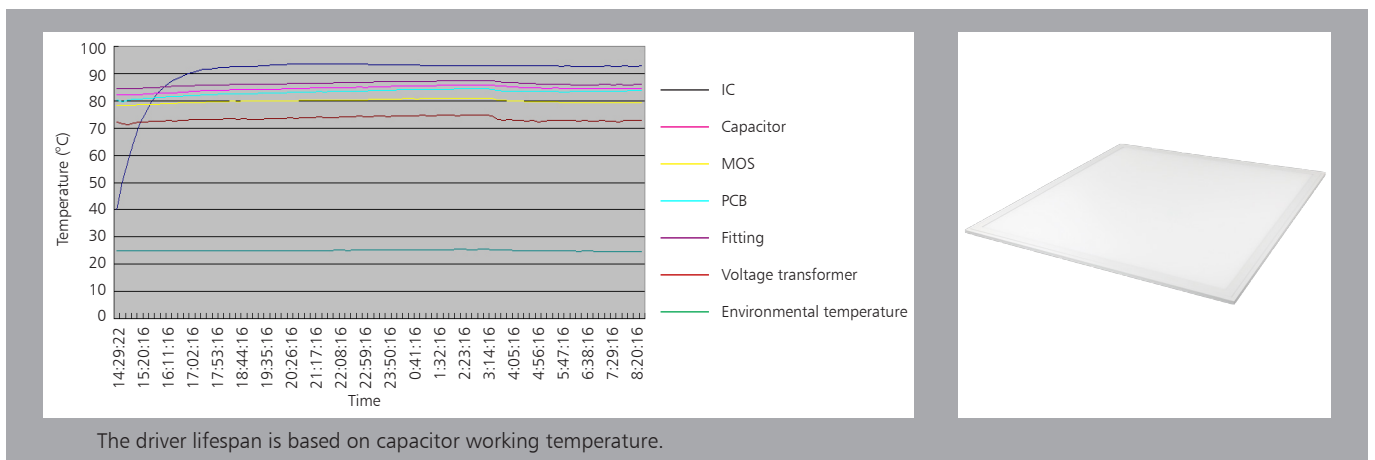

The driver lifespan is based on capacitor working temperature.

Installation

1. Recessed into ceiling

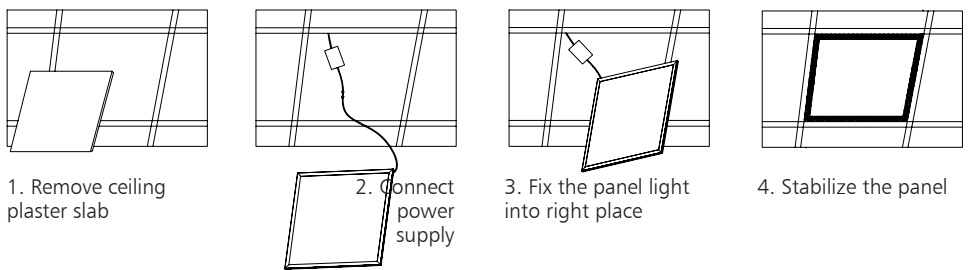

1. Remove ceiling plaster slab
2. Connect power supply
3. Fix the panel light into right place
4. Stabilize the panel

2. Suspending

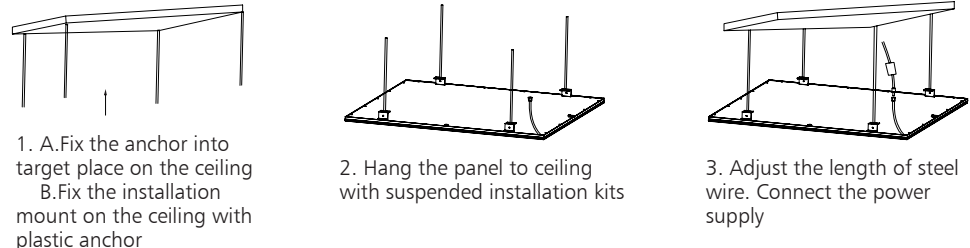

1. A. Fix the anchor into target place on the ceiling
B. Fix the installation mount on the ceiling with plastic anchor
2. Hang the panel to ceiling with suspended installation kits
3. Adjust the length of steel wire. Connect the power supply

3. Surface mounted

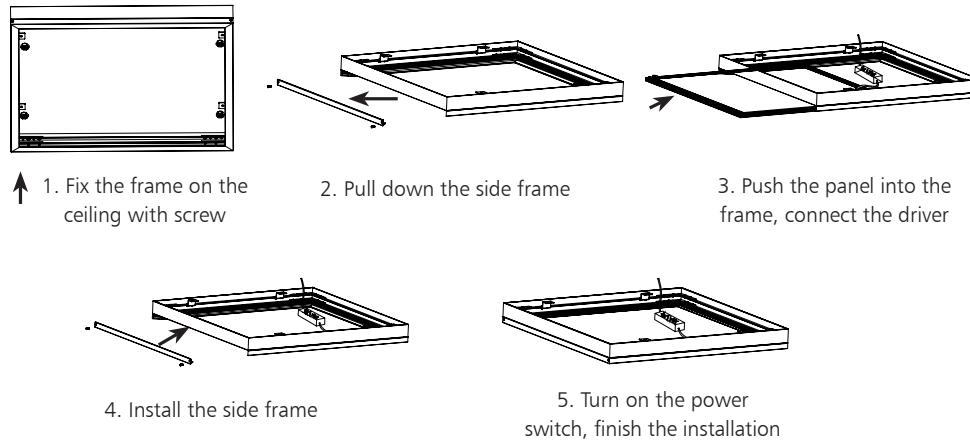

1. Fix the frame on the ceiling with screw
2. Pull down the side frame
3. Push the panel into the frame, connect the driver
4. Install the side frame
5. Turn on the power switch, finish the installation

Packaging Information

	SIZE(CM)	N.W/pc (KGS)	G.W.(KGS)	Q'TY(PCS)
Carton	68.5*25*74.5	3.1	21	5

	CTNS	Q'TY(PCS)	VOLUME(CBM)
20" standard container	215	1075	28
40" standard container	430	2150	56

