



# UPSHINE<sup>®</sup>



## Technical Application Guide for UP SHINE LED Panel Light

UP-PL30120-40W-AN-C3

UP-PL30120-40W-AN-P3



# Introduction



## Slide Switch Function

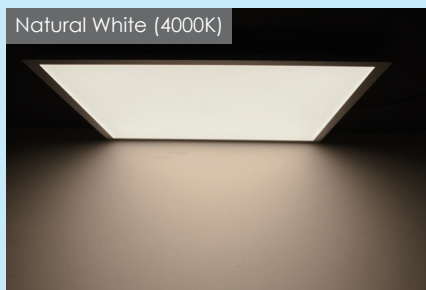
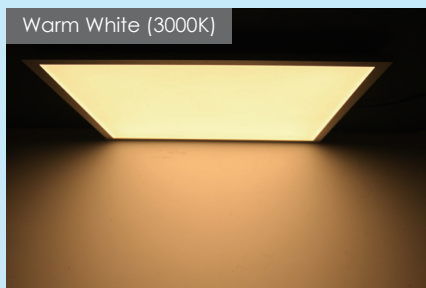
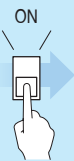

Creating fantastic atmosphere by flexible CCT changing between warm white, natural white and day light, the color changing led panel light are controlled by slide switch, which aims at reducing your stock by different color temperature and enables end users to choose suitable color for different applications freely. Once a color has been selected, you can also dim by triac dimmers, it is compatible with worldwide famous dimmers. 8~100% dimming range, smooth dimming effect and brightness changing, no flickering. Your ideal choice!

- Up to 80% energy saving compared to standard CFL
- Long lifetime of 40,000 hours
- Triac dim
- 120° wide beam angle
- CCT: 3000K 4000K 5700K
- No UV/IR light
- Environment friendly, without Mercury or any other hazardous substances

### Application notes

- IP40 for indoor use only
- Professional electrician for installation only
- Switch off before installation
- Do not touch when in use
- Keep away from hot steam and corrosive gas

### Application Areas

Office & school lighting: office room, meeting room, class room etc.

Commercial lighting: shopping mall, super market, retailer shops etc.

Other situations: hospital, laboratory, dust-free workshop etc.

### Certificates



# Product Information

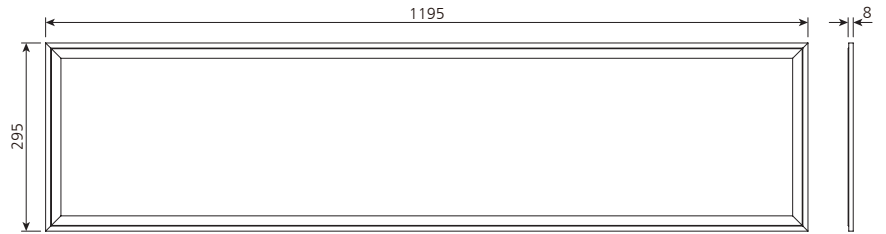

## Technical Specifications

Model	Voltage	Power	Power Factor	Lumen (±5%)	CCT	Beam angle	Lifespan	CRI	Dimmable	Dimension
UP-PL30120-40W-AN-C3	AC230V	40W	≥0.9	3120	3000K	120°	40000h	≥80	No	1195*295*8mm
				3750	4000K					
				3360	5700K					
UP-PL30120-40W-AN-P3	AC230V	40W	≥0.9	3120	3000K	120°	40000h	≥80	Yes	1195*295*8mm
				3750	4000K					
				3360	5700K					

## Driver data Sheet

Driver data	Non-dim	DIM
Input rated Voltage	AC230V	AC230V
Frequency	50Hz	50Hz
Input Voltage	AC200-240V	AC200-240V
Efficiency	≥83%	≥83%
Total load Wattage	40W±5%	40W±5%
Power Factor	≥0.9	≥0.9
Rated input current	≤0.23A	≤0.23A
Full load output Voltage	DC24-38V	DC24-38V
Rated output current	950mA	950mA
Output current range	950mA±5%	950mA±5%
Power tolerance	±5%	±5%
Current output tolerance	±5%	±5%
Dimming range	—	8%-100%
Short circuit protection	PASS	PASS
Over voltage protection	PASS	PASS
Over temperature protection	PASS	PASS
Withstand voltage	AC3750V	AC3750V

## Fixture Compatibility

Rated Wattage	Electrical Classification	Ingress Protection (IP)	Operating Temp	Operating Humidity	Storage Temp
40W	II	IP40	-20°C~45°C	0~90%	-20°C~65°C

# Spectral Distribution

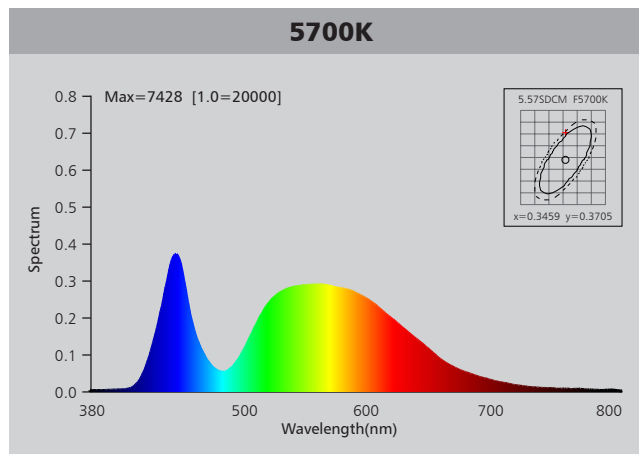
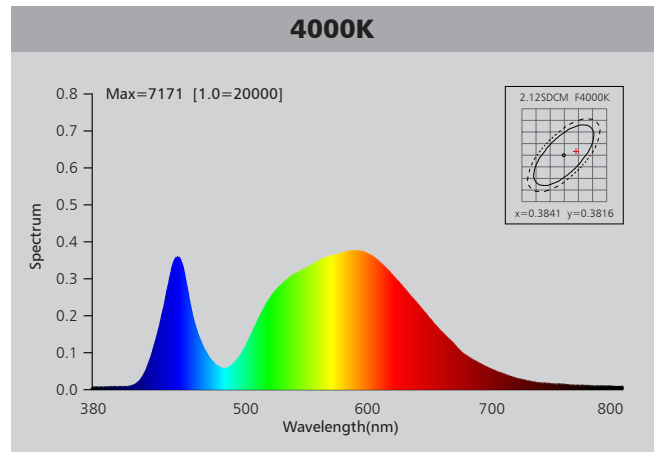
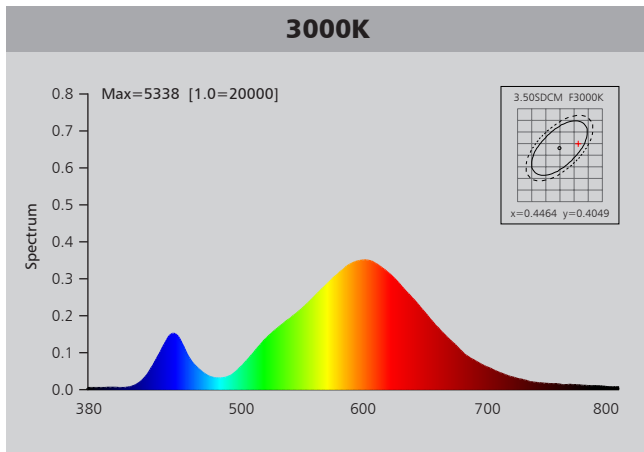

# Photometric Diagram

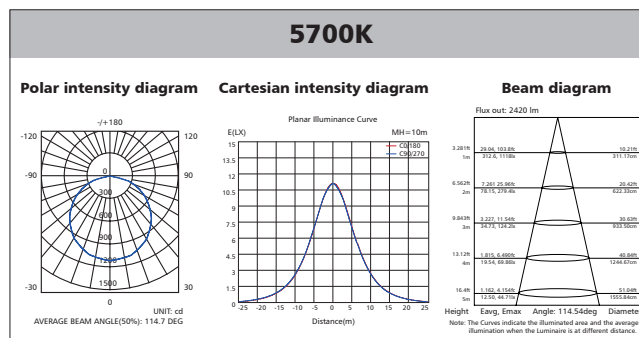
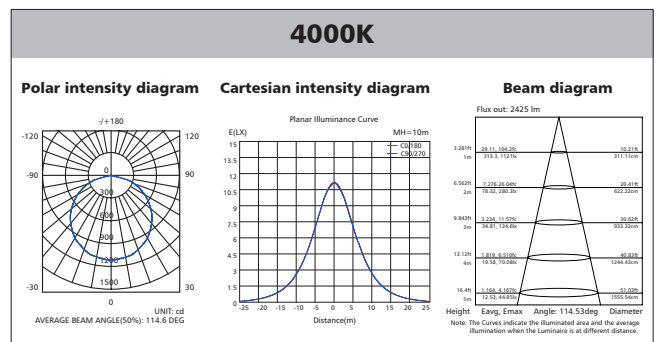
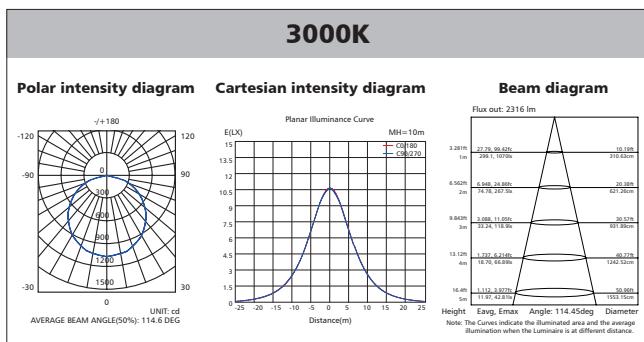

## Polar Diagram Comparison

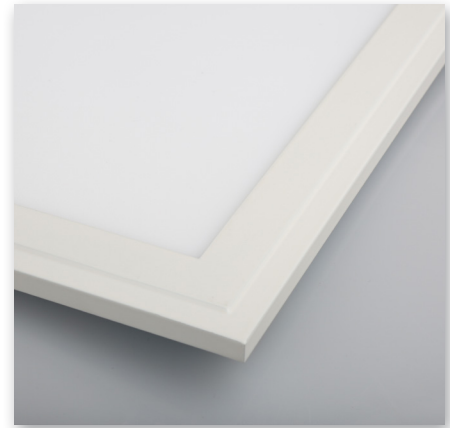
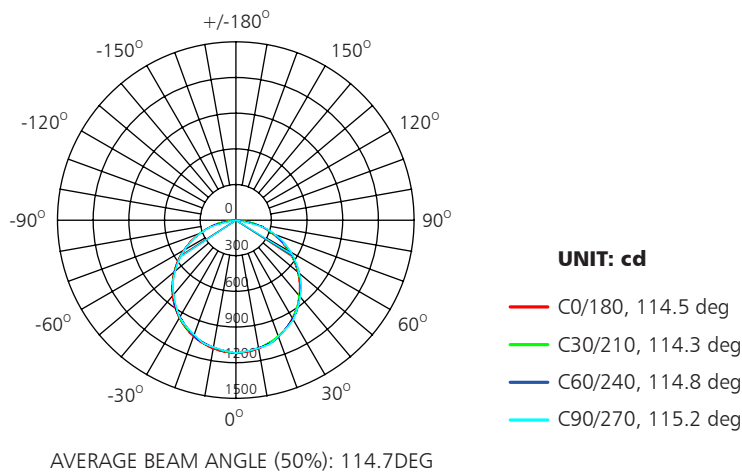

## Driver lifetime & LED light decay rate

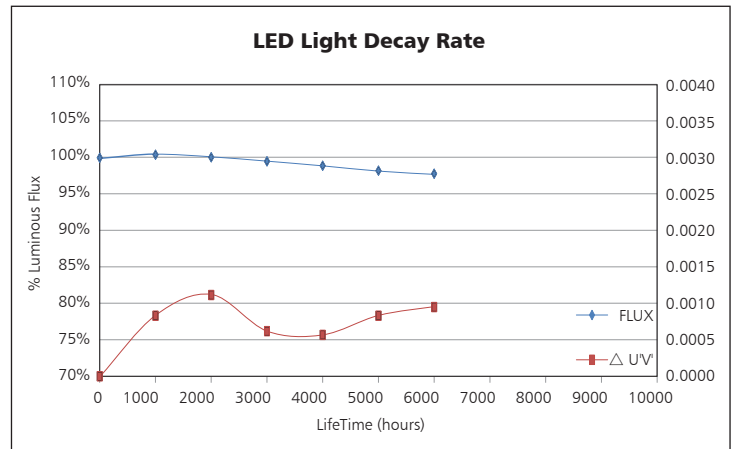
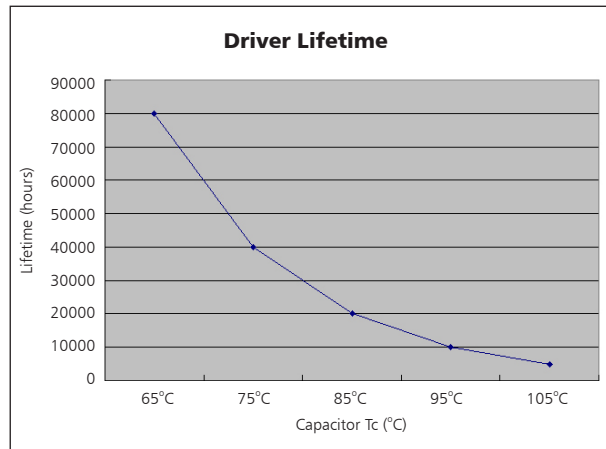

## Temperature

- The testing is operated at 25°C
- The lifetime of capacitor, minimum of 5,000 hours if operated at 105°C, will be doubled whenever the temperature drops 10°C
- The highest withstand temperature of IC, MOS could be 120°C
- The highest withstand temperature of LED junction temperature is 150°C

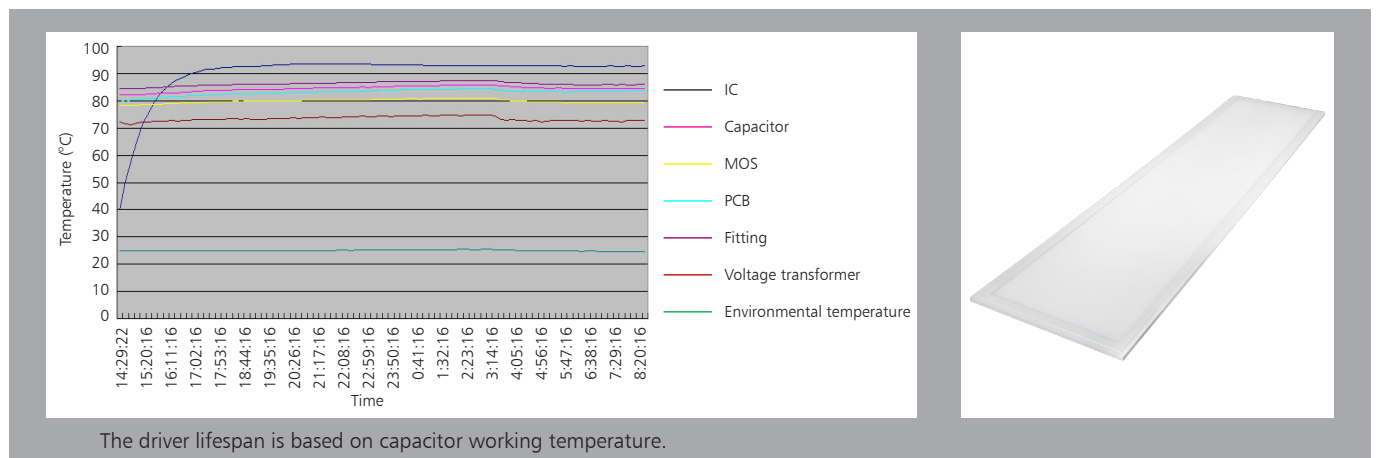

# Installation

**1. Recessed into ceiling**

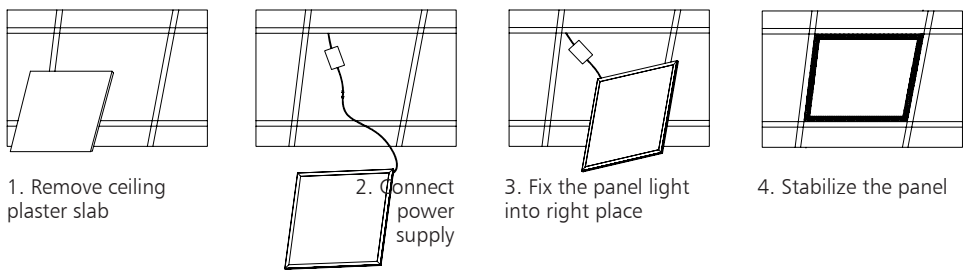

1. Remove ceiling plaster slab
2. Connect power supply
3. Fix the panel light into right place
4. Stabilize the panel

**2. Suspending**

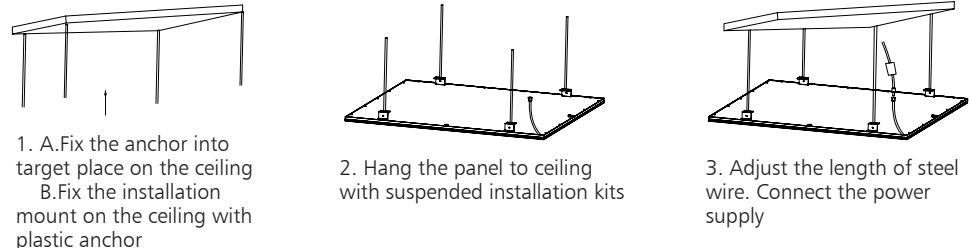

1. A. Fix the anchor into target place on the ceiling  
B. Fix the installation mount on the ceiling with plastic anchor
2. Hang the panel to ceiling with suspended installation kits
3. Adjust the length of steel wire. Connect the power supply

**3. Surface mounted**

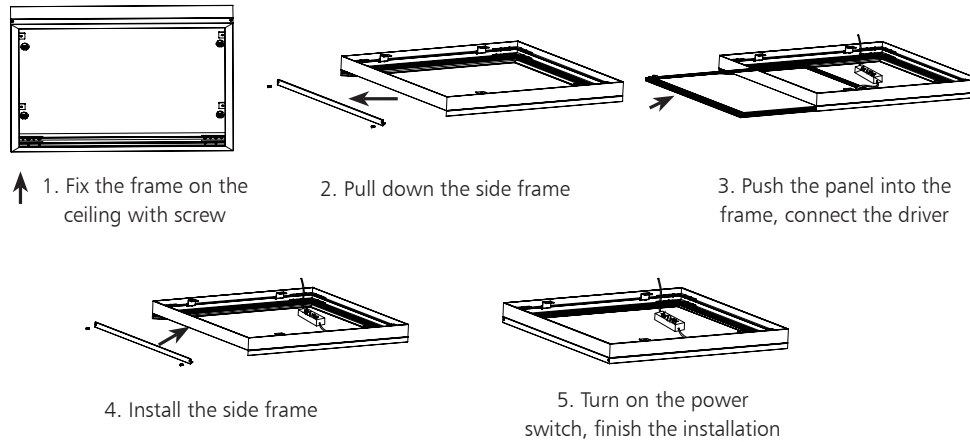

1. Fix the frame on the ceiling with screw
2. Pull down the side frame
3. Push the panel into the frame, connect the driver
4. Install the side frame
5. Turn on the power switch, finish the installation

# Packaging Information

	SIZE(CM)	N.W/pc (KGS)	G.W.(KGS)	Q'TY(PCS)
Carton	130*22.5*36	2.7	19.5	5

	CTNS	Q'TY(PCS)	VOLUME(CBM)
20" standard container	260	1300	28
40" standard container	520	2600	56

