

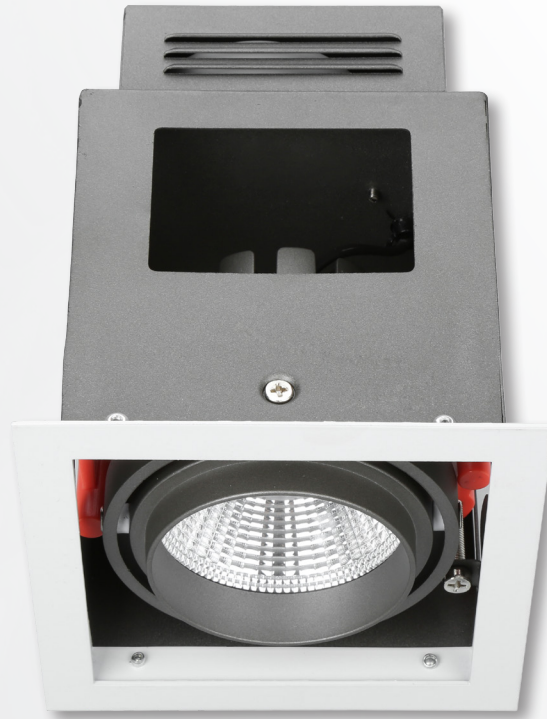

Up-shine® Lighting



Technical Application Guide for UP-SHINE LED Grille Downlight

UP-RD05-12W

Introduction



Up-shine rectangular LED grille downlight is unique designed with COB high power LED chip.

High efficient reflector with COB LED provides high lumen output and wide beam angle. Single head, double head and triple head provided for wide choice. Adjustable lighting direction offers various lighting orientation.

- Up to 70% energy saving compared to standard CFL
- Long lifetime of 40,000 hours
- 24° wide beam angle
- L115*W115mm cutout
- CCT: 2700K 3000K
4000K 5000K
- Adjustable and rotary
- No UV/IR light
- Environment friendly, without Mercury or any other hazardous substances

Application notes

- IP20 for indoor use only
- Professional electrician for installation only
- Switch off before installation
- Do not touch when in use
- Keep away from hot steam and corrosive gas

Application Areas

It is designed for general lighting applications in office, supermarket, shop, school, hotel, etc. It is also widely used for public areas, such as stairway, lobby, reception, corridors etc.

Certificate



Product Information

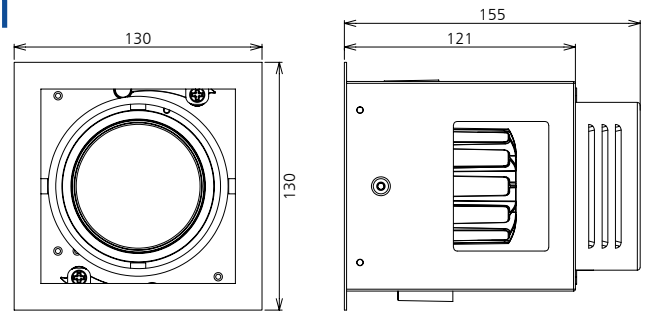

Technical Specifications

Model	Voltage	Power	Power Factor	Lumen (±5%)	Beam angle	CCT	Lifespan	CRI	Dimension
UP-RD05-12W	AC230V	12W	≥0.9	820	24°	2700K	40000h	≥80	L130*W130*H155mm cutout L115*W115mm
UP-RD05-12W	AC230V	12W	≥0.9	900	24°	3000K	40000h	≥80	L130*W130*H155mm cutout L115*W115mm
UP-RD05-12W	AC230V	12W	≥0.9	980	24°	4000K	40000h	≥80	L130*W130*H155mm cutout L115*W115mm
UP-RD05-12W	AC230V	12W	≥0.9	930	24°	5000K	40000h	≥80	L130*W130*H155mm cutout L115*W115mm

Driver data Sheet

Driver data	Non dim
Input rated Voltage	AC230V
Frequency	50Hz
Input Voltage	AC200-240V
Efficiency	≥85%
Total load Wattage	12W±1W
Power Factor	≥0.9
Rated input current	≤0.07A
Full load output Voltage	DC33-38V
Rated output current	300mA
Output current range	300mA±5%
Power tolerance	±5%
Current output tolerance	±5%
Dimming range	—
Dimmer	—
Short circuit protection	PASS
Over voltage protection	PASS
Over temperature protection	PASS
THD	≤20%
Withstand voltage	AC1500V

Fixture Compatibility

Rated Wattage	Electrical Classification	Ingress Protection	Operating Temp	Operating Humidity	Storage Temp
12W	I	IP20	-20°C~45°C	0~90%	-20°C~65°C

Spectral Distribution

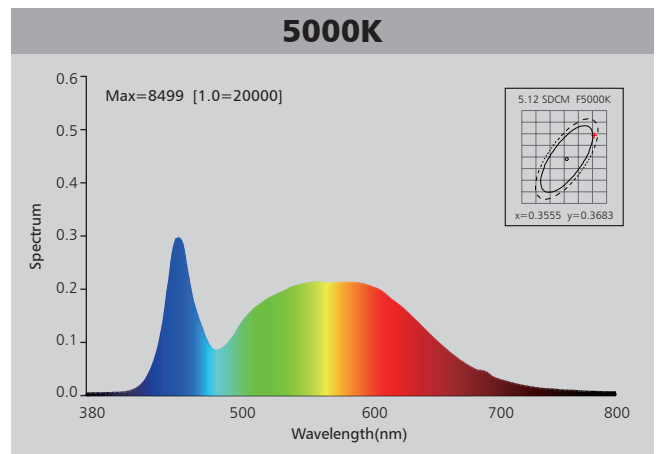
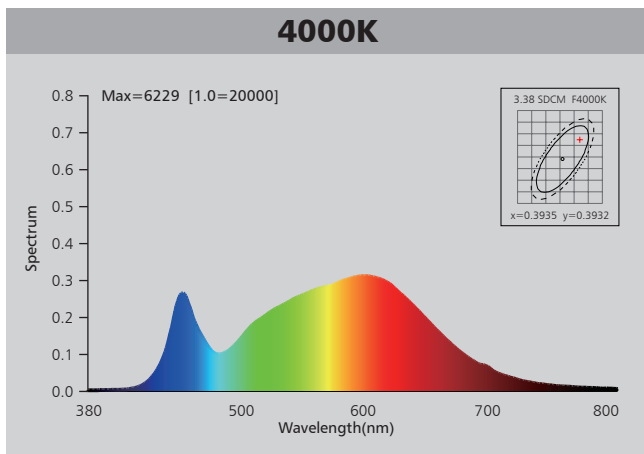
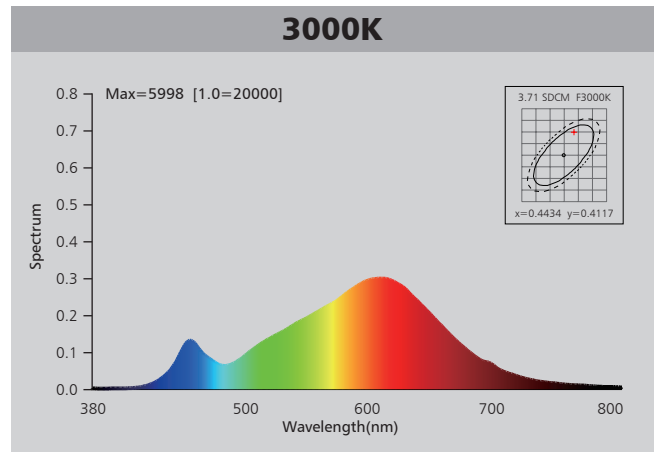
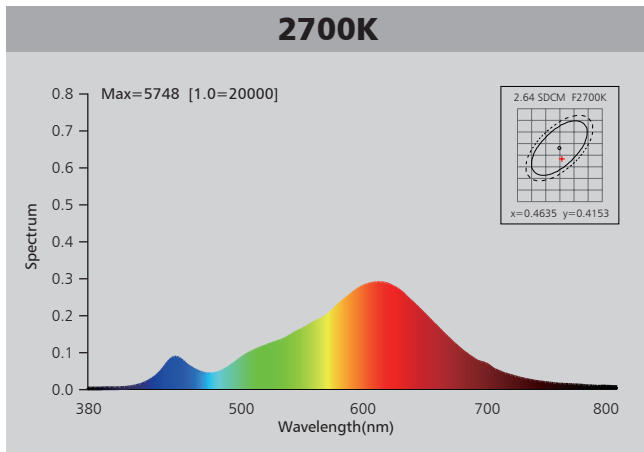

Photometric Diagram

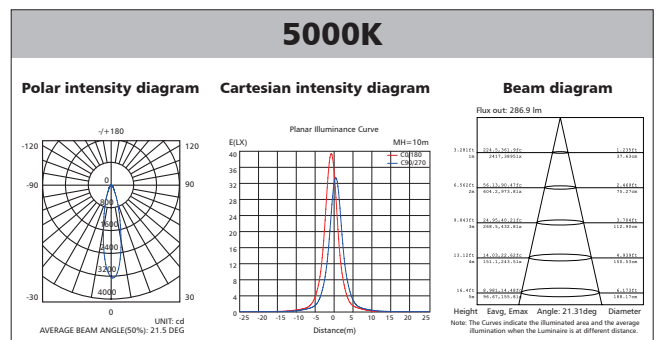
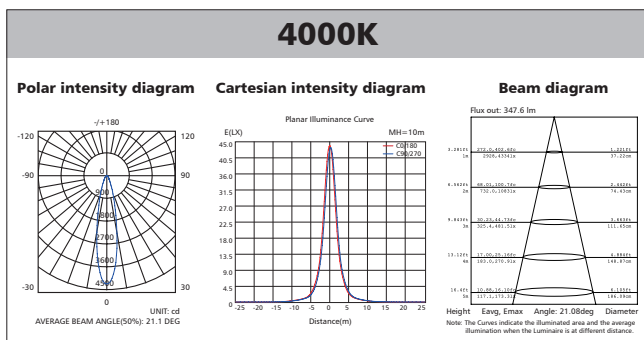
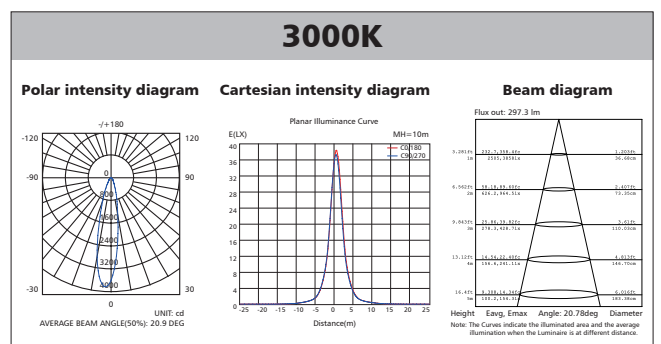
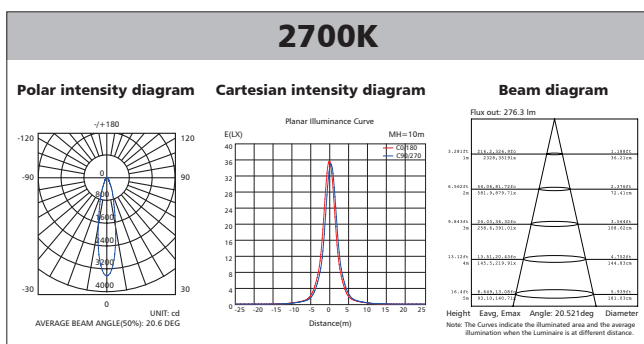

Polar Diagram Comparison

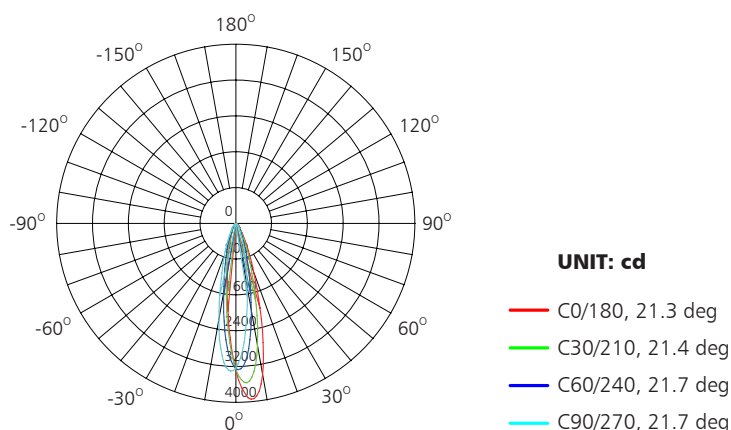

AVERAGE BEAM ANGLE (50%): 21.5DEG



Driver lifetime & LED light decay rate

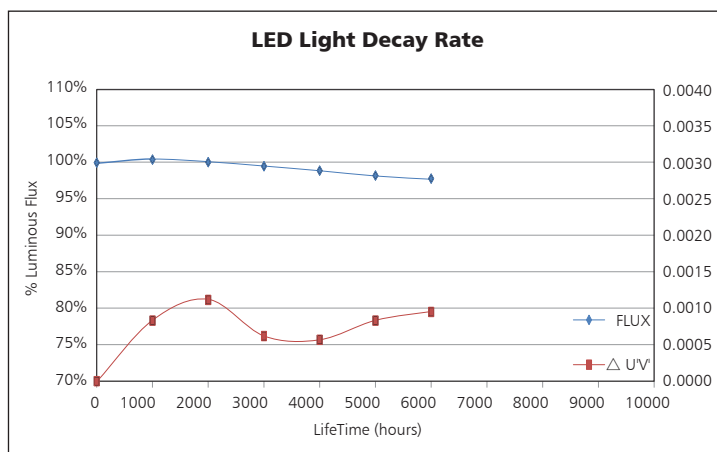
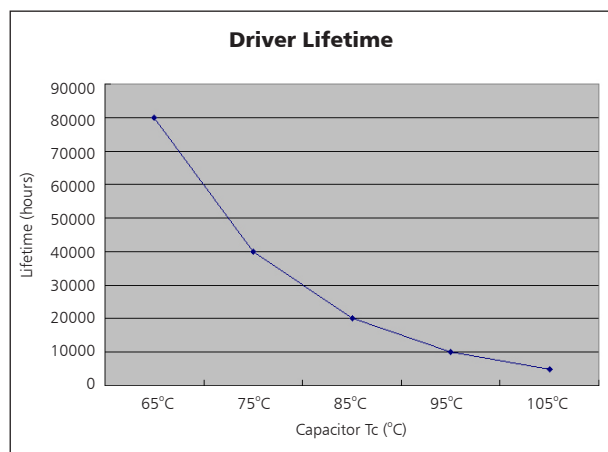

Temperature

- The testing is operated at 25°C
- The lifetime of capacitor, minimum of 5,000 hours if operated at 105°C, will be doubled whenever the temperature drops 10°C
- The highest withstand temperature of IC, MOS could be 120°C
- The highest withstand temperature of LED junction temperature is 150°C

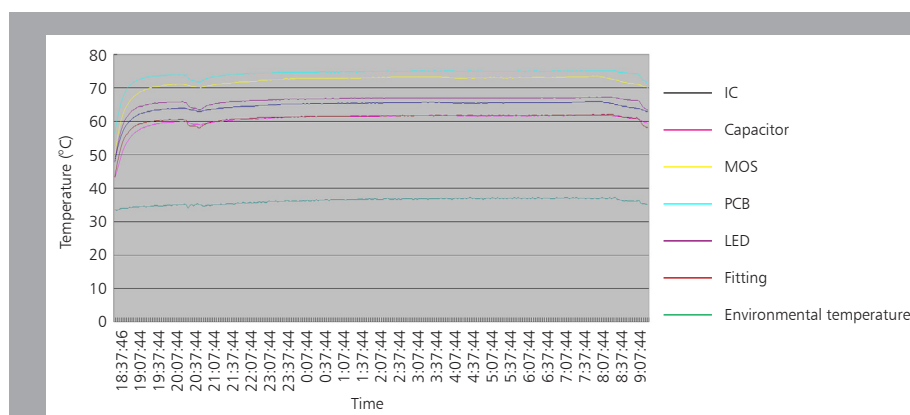

The driver lifespan is based on capacitor working temperature.

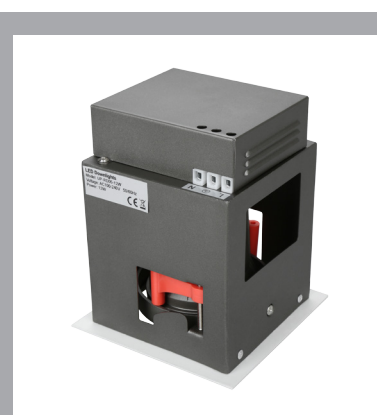

Installation

WARNING

1. Switch off before installation.
2. Switch on only after complete installation and examination of the circuit.
3. Professional electrician for installation and maintenance only.

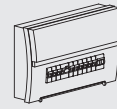

Step 1

Turn Off power supply before starting any installation. Read instructions & check you have all the tools & accessories to complete the installation correctly.

Step 2

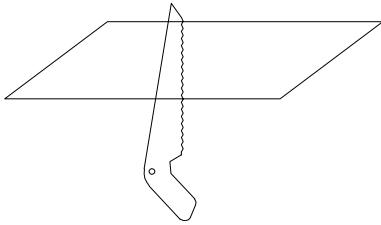

Open a hole on the ceiling according to cutout size of the lamp.

Step 3

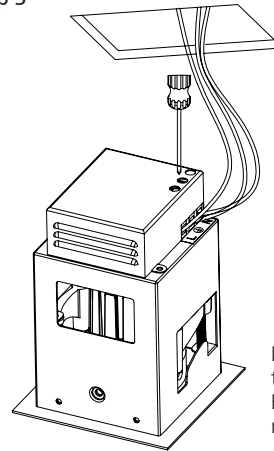

- L = SWITCHED
- EARTH
- N = NEUTRAL

Locking AC-L and AL-N into terminal blocks respectively. Ensure insulation protection measures done well.

Step 4

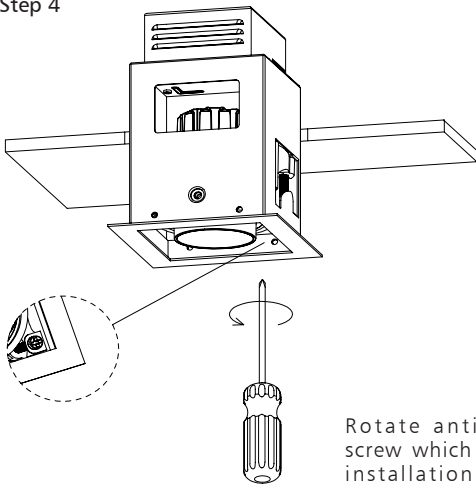

Rotate anticlockwise the screw which connected with installation fastener until fastener shrink back into lamp, then push whole lamp into hole.

Step 5

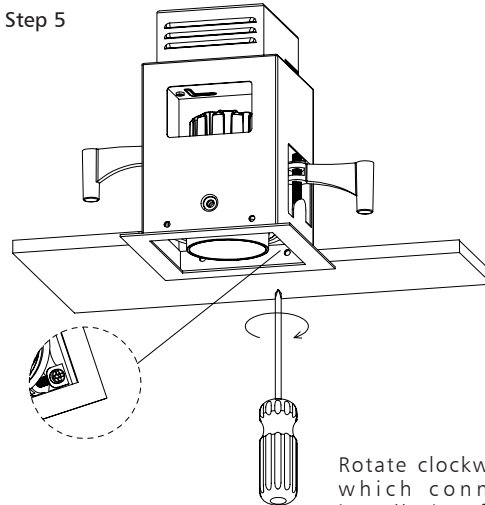

Rotate clockwise the screw which connected with installation fastener until fastener fix the ceiling tightly.

Step 6

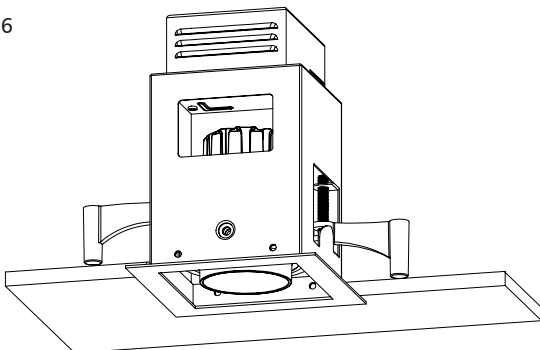

Ensure lamp fixture is securely fixed; install complete, switch on.

Packaging Information

	SIZE(CM)	N.W/pc (KGS)	G.W.(KGS)	Q'TY(PCS)
Carton	51*34.5*39.5	1.6	21.5	12

	CTNS	Q'TY(PCS)	VOLUME(CBM)
20" standard container	397	4764	28
40" standard container	794	9528	56

