



Up-shine[®] Lighting



Technical Application Guide for UP-SHINE LED Downlight

UP-DL98C-6-18W

UP-DL98C-6-18W-D

Introduction



DL98 model is an integrated downlight provides the perfect combination of efficiency, light comfort and design, without compromising on lighting performance (color rendering and color uniformity). It offers a wide choice of options for creating the desired ambience.

Features

1. Integrated SMD LED down lights with diffuser.
2. No external driver required which facilitates easy installation.
3. A perfect alternative to traditional ceiling mounted luminaires.
4. Looping from luminaires to luminaires with mains through-wiring.
5. Triac Dimmable version available.
6. Good heat dissipation to ensure long life.
7. Internal Driver

Application notes

- IP54 only for the LED cover, IP40 for other part
- The lamp must be installed by professional electrician
- Ensure the power supply is switched off before fitting this product
- Do not touch the lamp when in use
- Keep away from hot steam and corrosive gas

Application Areas

It is designed for general lighting applications in office, supermarket, shop, school, hotel, etc. It is also widely used for public areas, such as stairway, lobby, reception, corridors etc.

Certificate

CE RoHS



Product Information

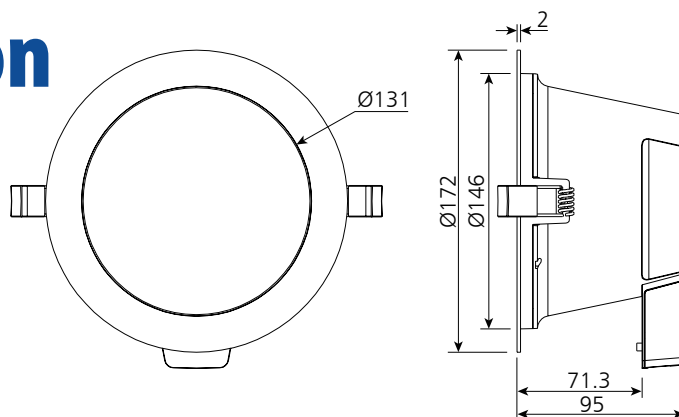

Technical Specifications

Model	Voltage	Power	Power Factor	Beam angle	Dimmable	Lumen (±5%)	CCT	Lifespan	CRI	Dimension
UP-DL98C-6-18W	AC100-277V	18W	≥0.9	90°	No	1730	3000K	50000h	≥80	Ø172*95mm cutout 150-165mm
						1840	4000K			
						1890	5000K			
						1780	5700K			
UP-DL98C-6-18W-D	AC200-240V	18W	≥0.9	90°	Yes	1690	3000K	50000h	≥80	Ø172*95mm cutout 150-165mm
						1800	4000K			
						1850	5000K			
						1730	5700K			

Driver data Sheet

Driver data	Dim	Non dim
Input rated Voltage	AC230V	AC100-277V
Frequency	50Hz	50/60Hz
Input Voltage	AC200-240V	AC90-305V
Efficiency	≥85%	≥86%
Total load Wattage	18W±1W	18W±1W
Power Factor	≥0.9	≥0.9
Rated input current	≤0.1A	≤0.2A
Full load output Voltage	DC65-75V	DC65-75V
Rated output current	220mA	250mA
Output current range	220mA±5%	250mA±5%
Power tolerance	±5%	±5%
Current output tolerance	±5%	±5%
Dimming range	8%-100%	—
Dimmer	Triac dimmers	—
Short circuit protection	PASS	PASS
Over voltage protection	PASS	PASS
Over temperature protection	PASS	PASS
THD	≤20% @ 230V	≤20% @ 230V
Withstand voltage	—	—

Fixture Compatibility

Rated Wattage	Electrical Classification	Ingress Protection	Operating Temp	Operating Humidity	Storage Temp
18W	II	IP40 / IP54	-20°C~45°C	0~90%	-20°C~65°C

Spectral Distribution

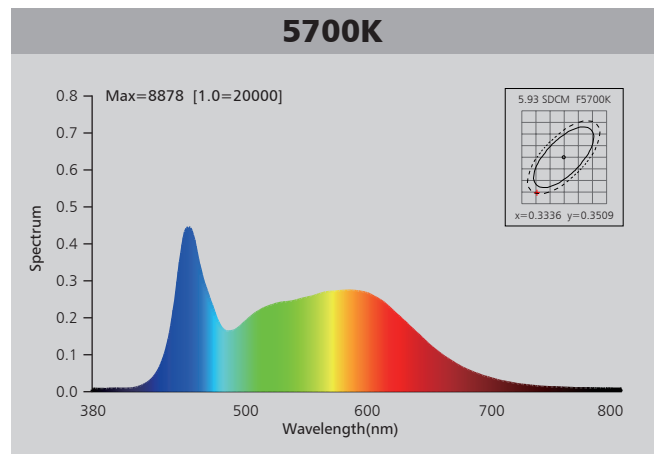
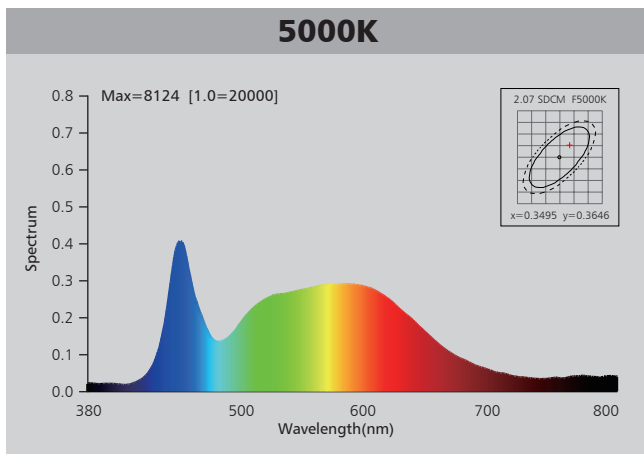
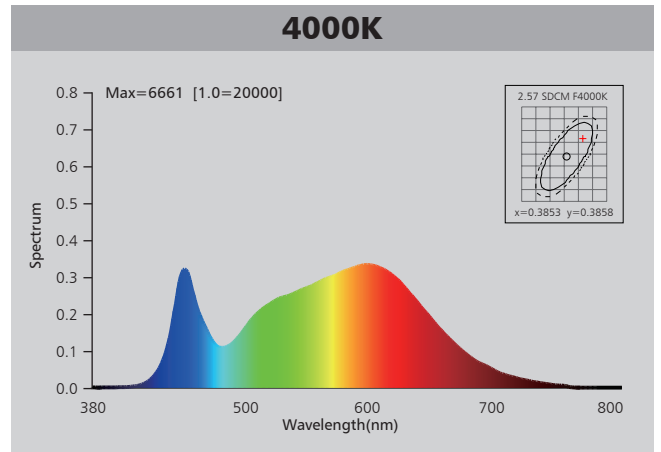
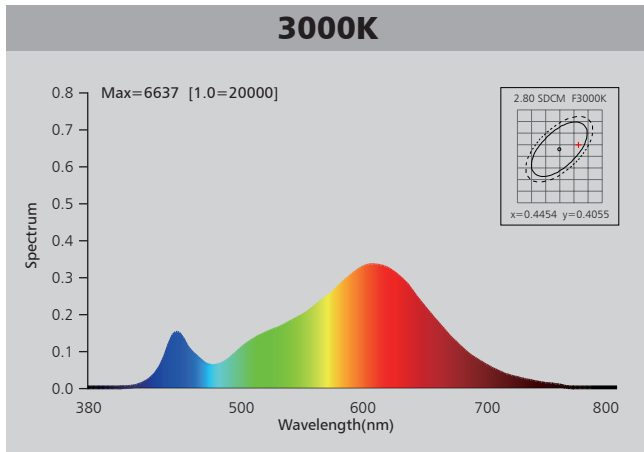

Photometric Diagram

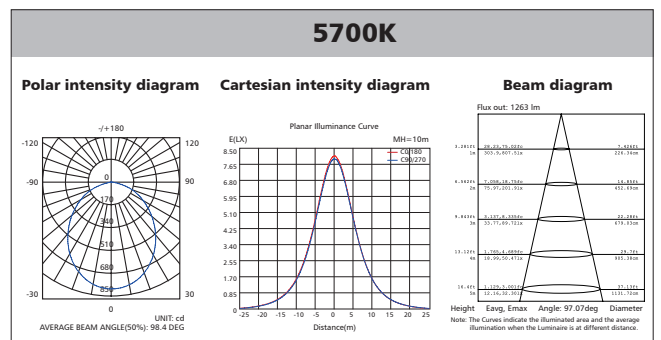
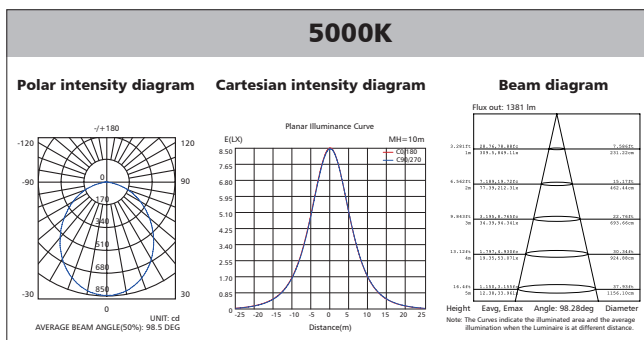
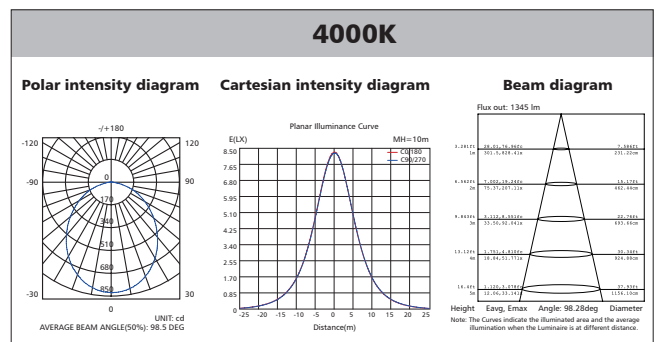
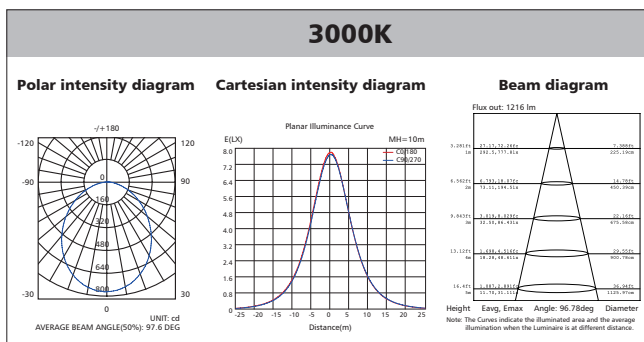

Polar Diagram Comparison

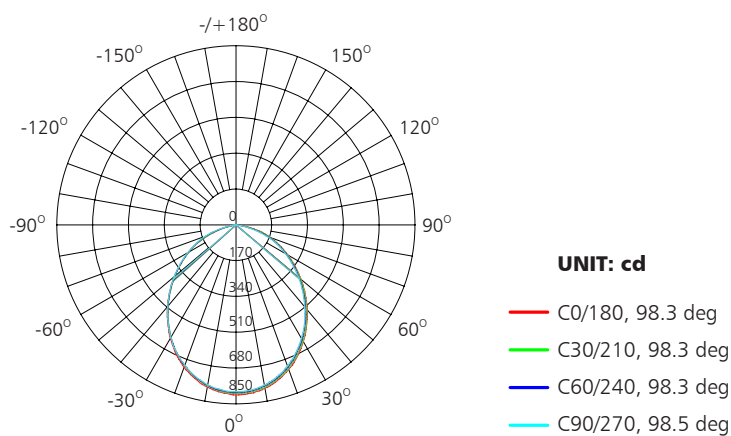

AVERAGE BEAM ANGLE (50%): 98.4DEG



Driver lifetime & LED light decay rate

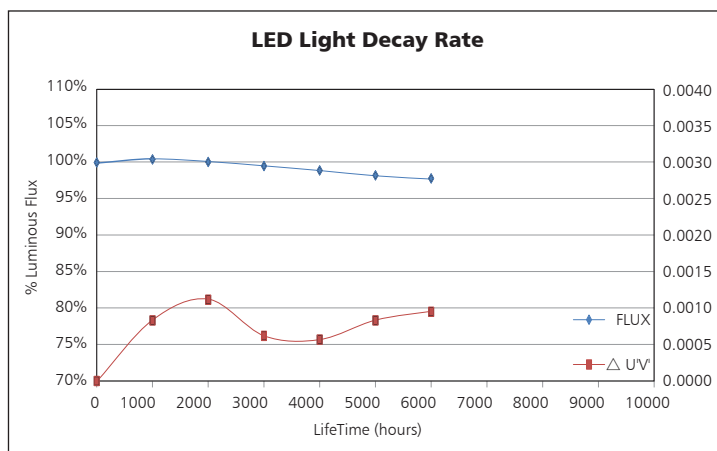
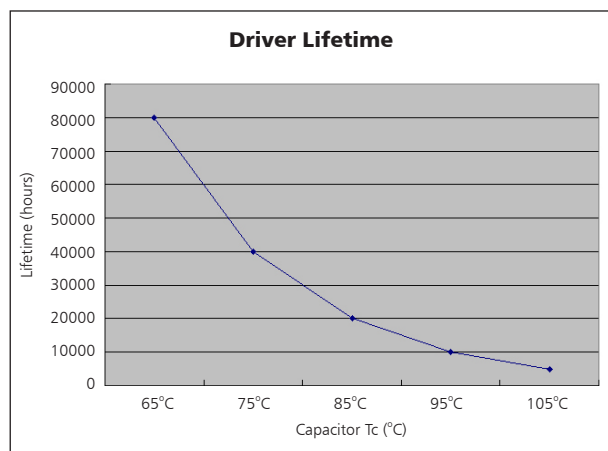

Temperature

- The testing is operated at 25°C
- The lifetime of capacitor, minimum of 5,000 hours if operated at 105°C, will be doubled whenever the temperature drops 10°C
- The highest withstand temperature of IC, MOS could be 120°C
- The highest withstand temperature of LED junction temperature is 150°C

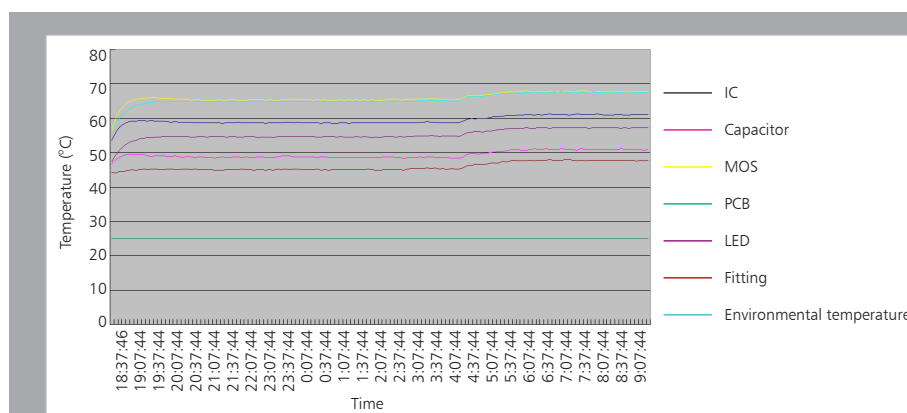

The driver lifespan is based on capacitor working temperature.

Installation

Install requirements	
A-gap above the fitting	25mm
B-gap to the building material	25mm
C-gap to the thermal insulation	25mm

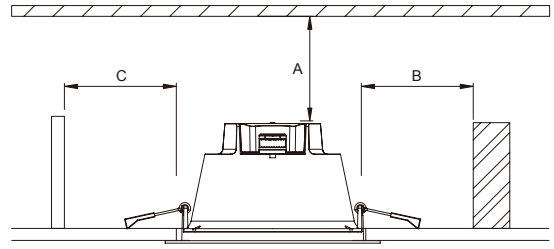

1. Open a hole according to the cutout size of led downlight.

Figure 1

2. Open the line pressing cover, see Figure 1. (Model dependent): Choose the CCT by slide switch, see Figure 2.

3. Put the main AC wire through line pressing clip, feed the L.N to the fast connection terminal block respectively then compress the line pressing clip.

L = Brown
N = Blue

4. Close the line pressing cover tightly.

5. Hold back spring clips then push downlight into the hole.

6. Make sure the downlight fixed tightly in ceiling, turn on the power.

Packaging Information

	SIZE(CM)	N.W/pc (KGS)	G.W.(KGS)	Q'TY(PCs)
Carton	41*41*44	0.35	6	12

	CTNS	Q'TY(PCs)	VOLUME(CBM)
20" standard container	372	4464	28
40" standard container	746	8952	56

