



Up-shine[®] Lighting



Technical Application Guide for UP-SHINE LED Downlight

UP-DL97-4-15W

Introduction



Up-shine SMD LED Down light adopts high lumen SMD LED, PC diffuser with even light output. White, silver, chrome surface treatment are available for customer's preference.

Triac dimmable, 0-10V dimmable and DALI dimmable version share great popularity by excellent dimming effect.

- Up to 70% energy saving compared to standard CFL
- Long lifetime of 40,000 hours
- Dimmable when using triac dimmer
- 90° wide beam angle
- Ø120-130mm cutout
- CCT: 3000K 4000K
5000K 5700K
- No UV/IR light
- Environment friendly, without Mercury or any other hazardous substances

Application notes

- IP54 for indoor use
- Professional electrician for installation only
- Switch off before installation
- Do not touch when in use
- Keep away from hot steam and corrosive gas

Application Areas

It is designed for general lighting applications in office, supermarket, shop, school, hotel, etc. It is also widely used for public areas, such as stairway, lobby, reception, corridors etc.

Certificate

CE RoHS



Product Information

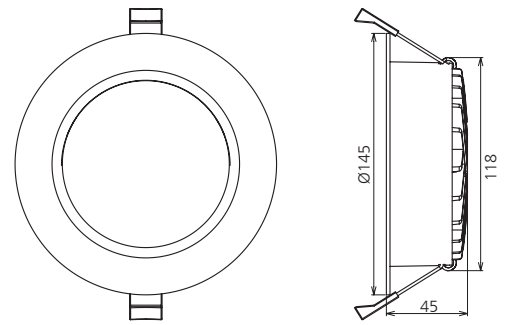

Technical Specifications

Model	Voltage	Power	Power Factor	Lumen (±5%)	Beam angle	CCT	Lifespan	CRI	Dimmable	Dimension
UP-DL97-4-15W	AC230V	15W	≥0.9	1450	90°	3000K	40000h	≥80	No	Ø145*45mm cutout 120-130mm
UP-DL97-4-15W	AC230V	15W	≥0.9	1500	90°	4000K	40000h	≥80	No	Ø145*45mm cutout 120-130mm
UP-DL97-4-15W	AC230V	15W	≥0.9	1530	90°	5000K	40000h	≥80	No	Ø145*45mm cutout 120-130mm
UP-DL97-4-15W	AC230V	15W	≥0.9	1560	90°	5700K	40000h	≥80	No	Ø145*45mm cutout 120-130mm
UP-DL97-4-15W-D	AC230V	15W	≥0.9	1420	90°	3000K	40000h	≥80	Yes	Ø145*45mm cutout 120-130mm
UP-DL97-4-15W-D	AC230V	15W	≥0.9	1470	90°	4000K	40000h	≥80	Yes	Ø145*45mm cutout 120-130mm
UP-DL97-4-15W-D	AC230V	15W	≥0.9	1500	90°	5000K	40000h	≥80	Yes	Ø145*45mm cutout 120-130mm
UP-DL97-4-15W-D	AC230V	15W	≥0.9	1530	90°	5700K	40000h	≥80	Yes	Ø145*45mm cutout 120-130mm

Driver data Sheet

Driver data	DIM	Non dim
Input rated Voltage	AC230V	AC230V
Frequency	50Hz	50/60Hz
Input Voltage	AC200-240V	AC200-240V
Efficiency	≥83%	≥84%
Total load Wattage	15W±1W	15W±1W
Power Factor	≥0.9	≥0.9
Rated input current	≤0.09A	≤0.1A
Full load output Voltage	DC23-40V	DC25-42V
Rated output current	350mA	350mA
Output current range	350mA±5%	350mA±5%
Power tolerance	±5%	±5%
Current output tolerance	±5%	±5%
Dimming range	8%-100%	—
Dimmer	Triac dimmers	—
Short circuit protection	PASS	PASS
Over voltage protection	PASS	PASS
Over temperature protection	PASS	PASS
THD	≤18%	≤18%
Withstand voltage	AC3750V	AC3750V

Fixture Compatibility

Rated Wattage	Electrical Classification	Ingress Protection	Operating Temp	Operating Humidity	Storage Temp
15W	II	IP54	-20°C~45°C	0~90%	-20°C~65°C

Spectral Distribution

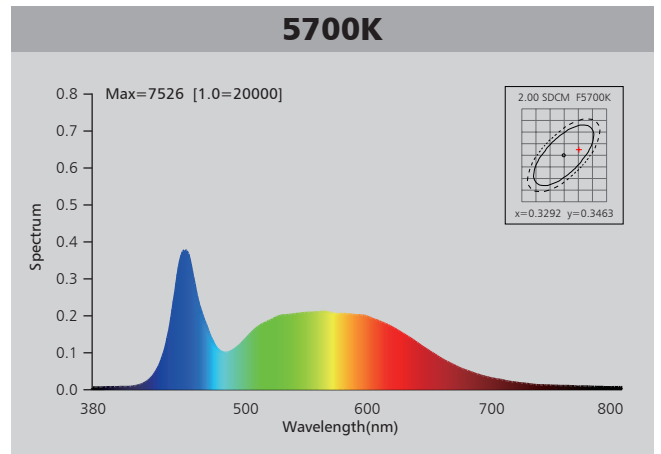
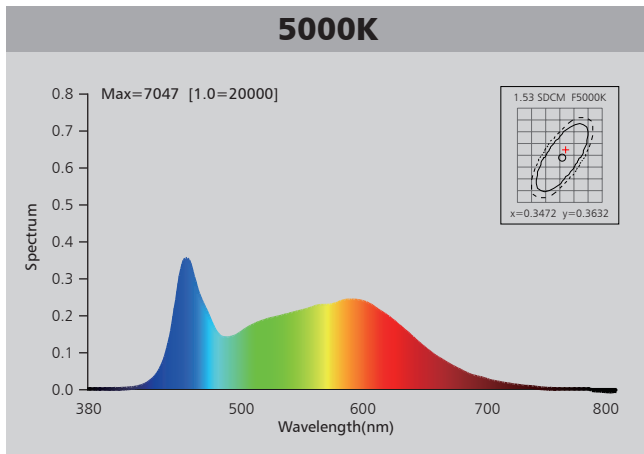
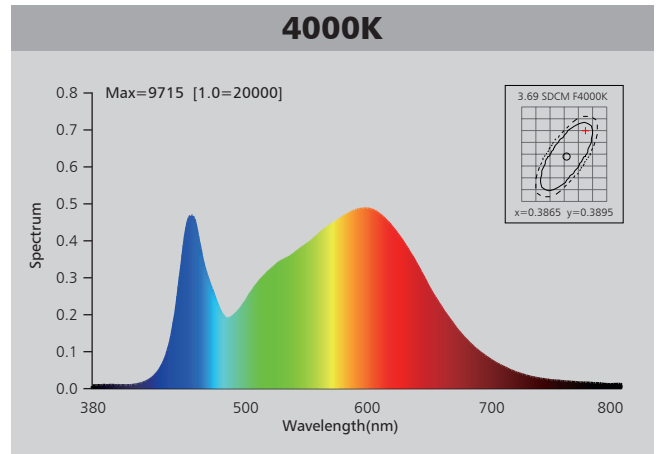
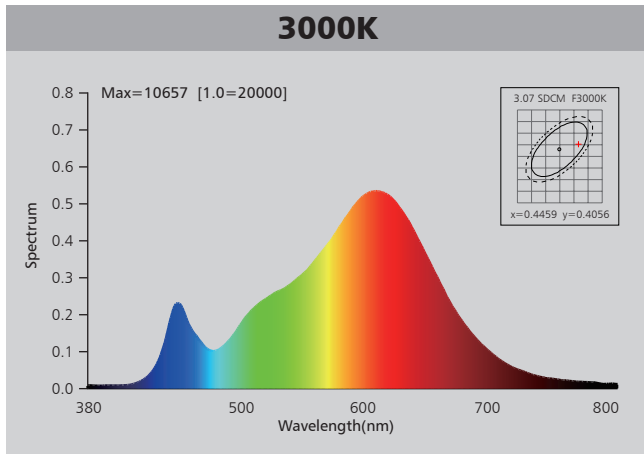

Photometric Diagram

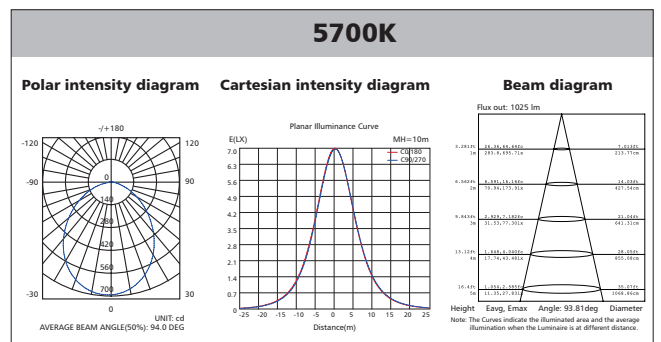
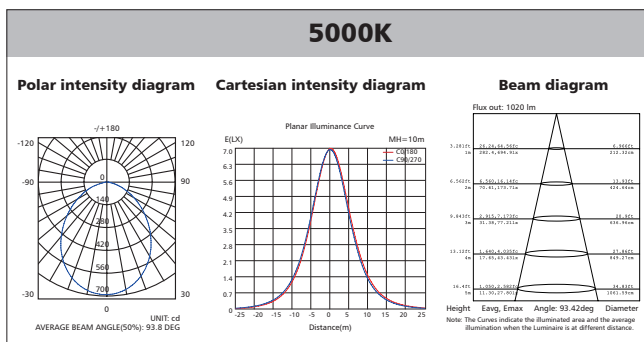
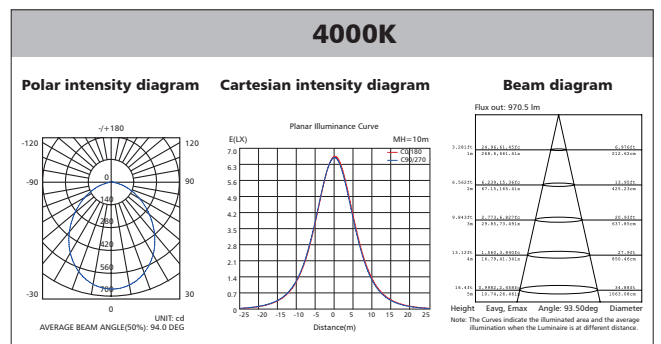
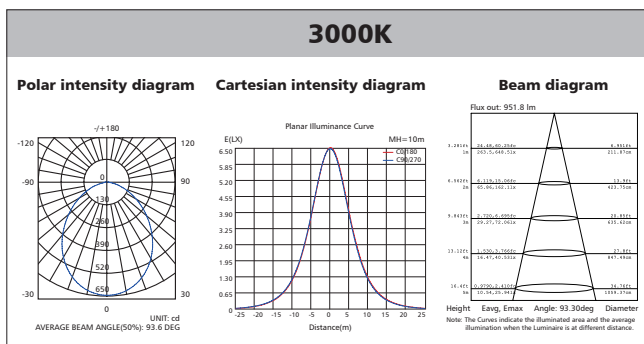

Polar Diagram Comparison

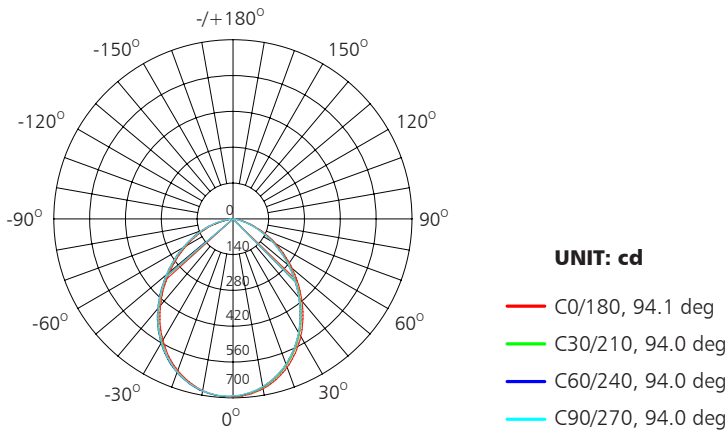

AVERAGE BEAM ANGLE (50%): 94.0DEG



Driver lifetime & LED light decay rate

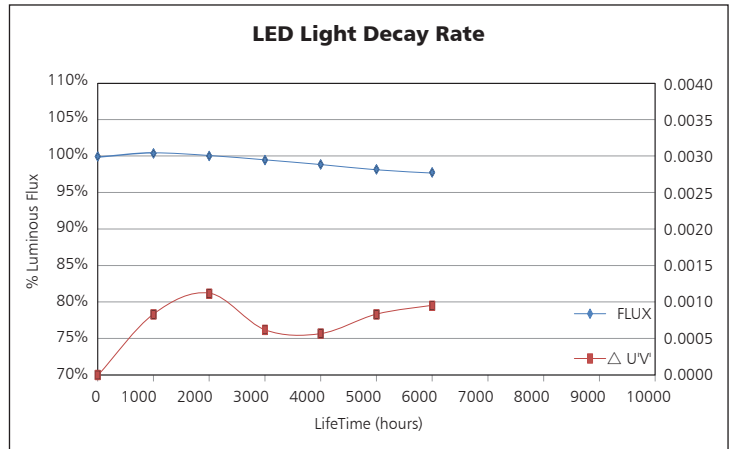
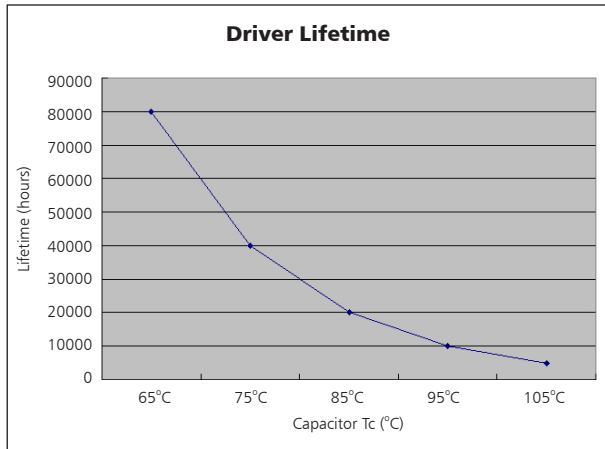

Temperature

- The testing is operated at 25°C
- The lifetime of capacitor, minimum of 5,000 hours if operated at 105°C, will be doubled whenever the temperature drops 10°C
- The highest withstand temperature of IC, MOS could be 120°C
- The highest withstand temperature of LED junction temperature is 150°C

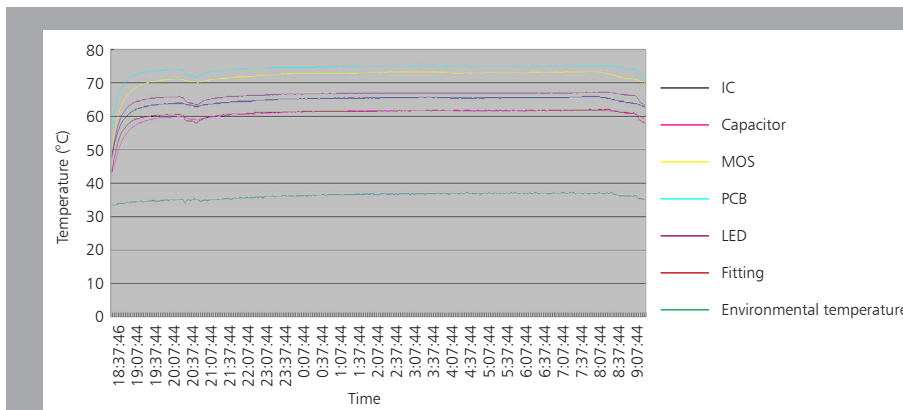

The driver lifespan is based on capacitor working temperature.

Installation

Install requirements	
A-gap above the fitting	25mm
B-gap to the building material	25mm
C-gap to the thermal insulation	25mm

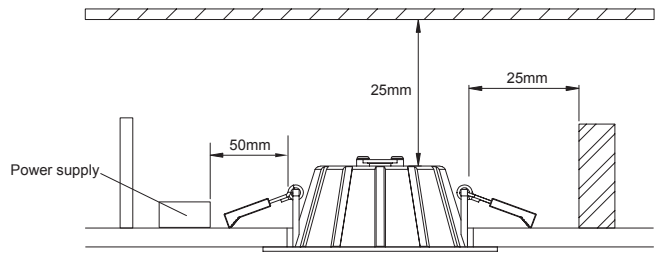

1. Open a hole according to the cutout size of led downlight.

2. Use screw-driver to open the driver terminal cover, feed the main AC wire L. N. in terminal block respectively, then fix the cover back.

3. Connect the downlight with driver, hold back the spring clip then push the downlight into the hole.

4. Make sure the downlight fixed tightly in ceiling, turn on the power (Fig 1).

Packaging Information

	SIZE(CM)	N.W/pc (KGS)	G.W.(KGS)	Q'TY(PCS)
Carton	49*33*48	0.39	15.5	30

	CTNS	Q'TY(PCS)	VOLUME(CBM)
20" standard container	356	10680	28
40" standard container	712	21360	56

