



Up-shine[®] Lighting



Technical Application
Guide for UP-SHINE
LED Downlight
UP-DL97-3-10W-W1



Introduction

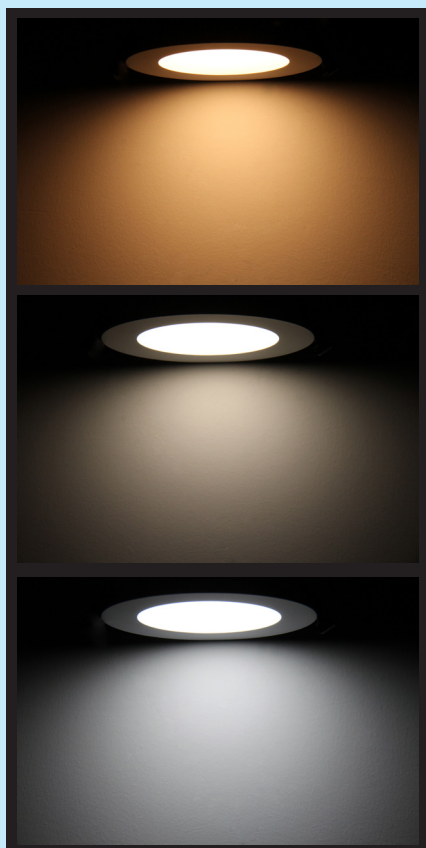

2.4G WiFi wireless led downlight comes with a Wi-Fi remote controller and it can also be conveniently used to be operated through regular switches or mobile phone. You can have complete home lighting control right in your pocket. After installing the downlight, download a free application to your smart phone and you are ready to control lights with mobile phone. You may change the color to set an appropriate mood and to match the room decor.

- Up to 80% energy saving compared to standard CFL
- Long lifetime of 50,000 hours (25°C)
- 90° wide beam angle
- Ø90-95mm cutout
- WIFI(2.4G)
- No UV/IR light
- Environment friendly, without Mercury or any other hazardous substances

Application notes

- IP54 for indoor use
- Professional electrician for installation only
- Switch off before installation
- Do not touch when in use
- Keep away from hot steam and corrosive gas

Application Areas

It is designed for general lighting applications in office, supermarket, shop, school, hotel, etc. It is also widely used for public areas, such as stairway, lobby, reception, corridors etc.

Certificates

CE **RoHS**



QR code for IOS
(APP STORE)



QR code for Android

2.4G&Wifi Intelligent Control

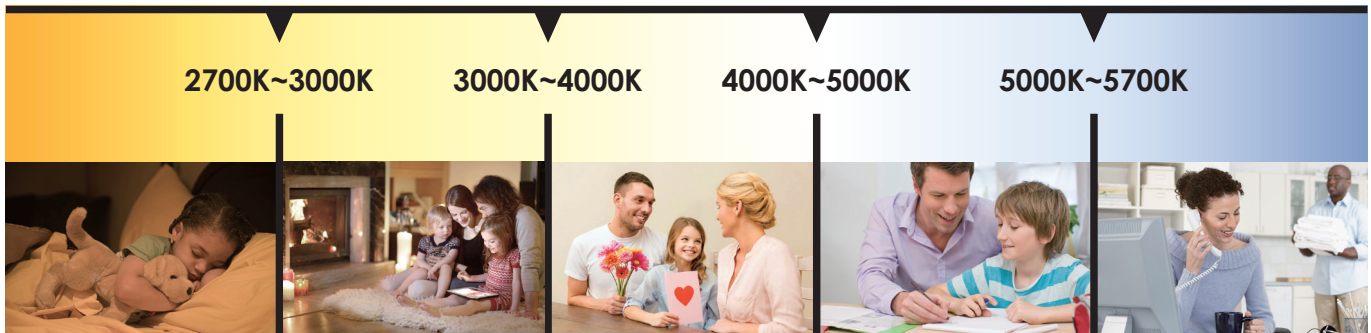

2.4G Remote controller



WiFi Box (Mobile App)



Color Changeable



Dimmable

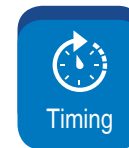

Timing

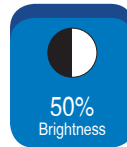

50% Brightness



Night Lamp

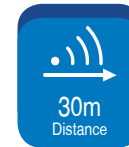

30m Distance



2700K~5700K Changeable

Creating fantastic atmosphere by flexible CCT changing between warm white, natural white and day light, the color changing items are controlled by remote controller, wall touch switch or smart phone APP.



8%~100% Dimmable

Dimmable from 8%~100% brightness with timing and night lamp function, diversified scene setting, creating a humanized smart control system.



Product Information

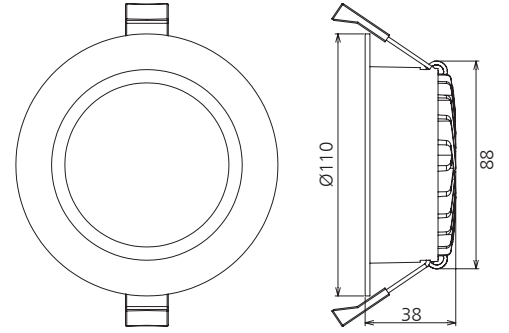

Technical Specifications

Model	Voltage	Power	Power Factor	Lumen (±5%)	Beam angle	CCT	Lifespan	CRI	Dimmable	Dimension
UP-DL97-3-10W-W1	AC230V	10W	≥0.9	800 ⋮ 950 ⋮ 850	90°	2700K ⋮ 4000K ⋮ 5700K	50000h	≥80	Yes	Ø110*38mm cutout 90-95mm

Driver data Sheet

Driver data	DIM
Input rated Voltage	AC230V
Frequency	50Hz
Input Voltage	AC200-240V
Efficiency	≥80%
Total load Wattage	10W±1W
Power Factor	≥0.9
Rated input current	≤0.06A
Full load output Voltage	DC24-38V
Rated output current	230mA
Output current range	230mA±5%
Power tolerance	±5%
Current output tolerance	±5%
Dimming range	8%-100%
Dimmer	Triac dimmers
Short circuit protection	PASS
Over voltage protection	PASS
Over temperature protection	PASS
THD	≤18%
Withstand voltage	AC3750V

Fixture Compatibility

Rated Wattage	Electrical Classification	Ingress Protection	Operating Temp	Operating Humidity	Storage Temp
10W	II	IP54	-20°C~45°C	0~90%	-20°C~65°C

Spectral Distribution

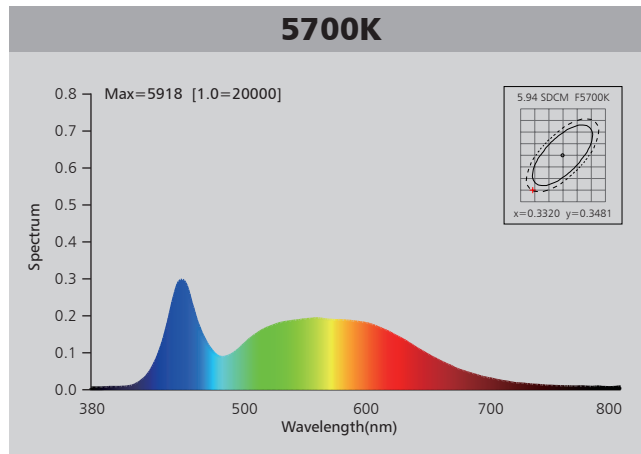
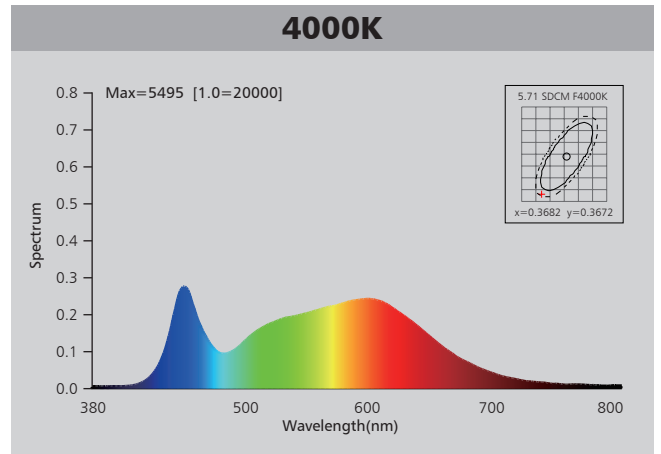
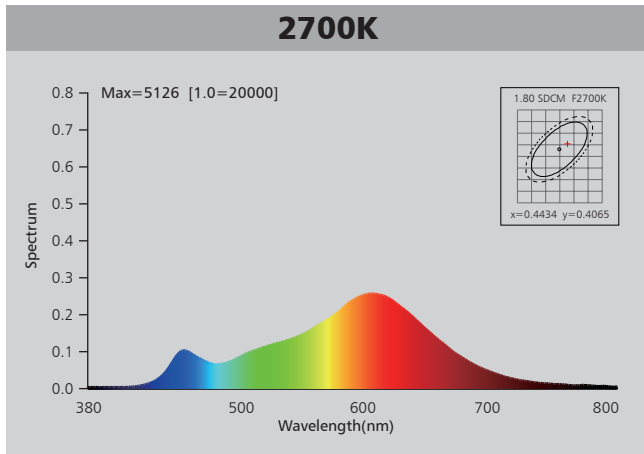

Photometric Diagram

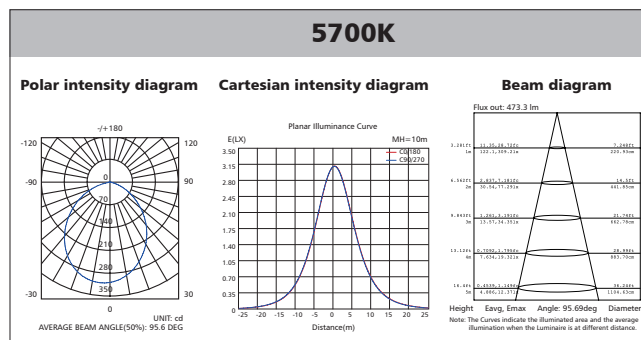
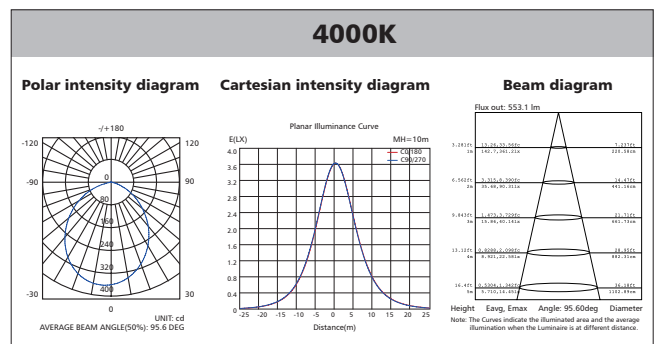
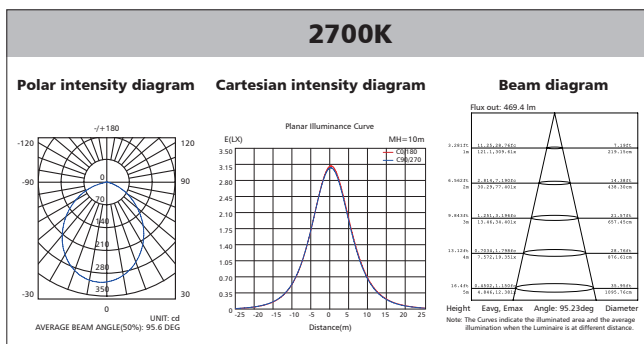

Polar Diagram Comparison

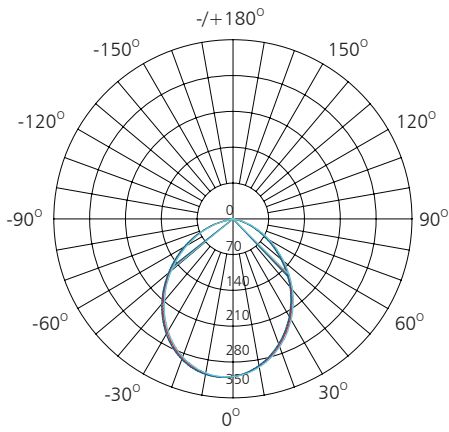

UNIT: cd

- C0/180, 95.7 deg
- C30/210, 95.5 deg
- C60/240, 95.5 deg
- C90/270, 95.8 deg

AVERAGE BEAM ANGLE (50%): 95.6DEG



Driver lifetime & LED light decay rate

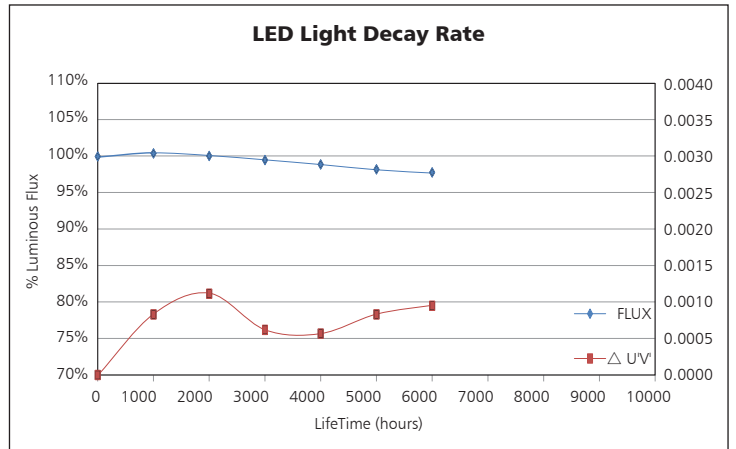
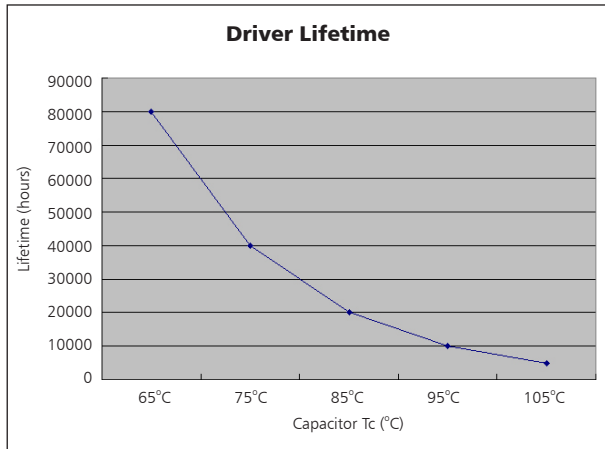

Temperature

- The testing is operated at 25°C
- The lifetime of capacitor, minimum of 5,000 hours if operated at 105°C, will be doubled whenever the temperature drops 10°C
- The highest withstand temperature of IC, MOS could be 120°C
- The highest withstand temperature of LED junction temperature is 150°C

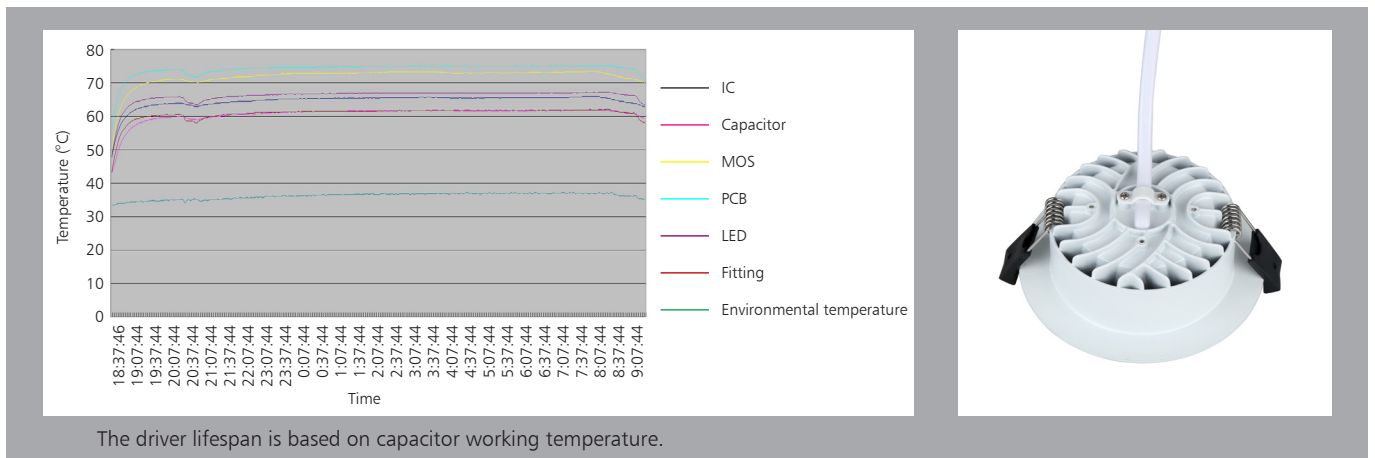

The driver lifespan is based on capacitor working temperature.

Installation

Install requirements	
A-gap above the fitting	25mm
B-gap to the building material	25mm
C-gap to the thermal insulation	25mm

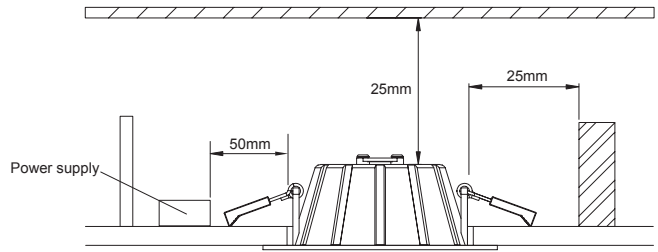

1. Open a hole according to the cutout size of led downlight.

2. Use screw-driver to open the driver terminal cover, feed the main AC wire L, N. in terminal block respectively, then fix the cover back.

3. Connect the downlight with driver, hold back the spring clip then push the downlight into the hole.

4. Make sure the downlight fixed tightly in ceiling, turn on the power (Fig 1).

Packaging Information

	SIZE(CM)	N.W/pc (KGS)	G.W.(KGS)	Q'TY(PCS)
Carton	48.5*37*29.5	0.3	15	36

	CTNS	Q'TY(PCS)	VOLUME(CBM)
20" standard container	519	18684	28
40" standard container	1038	37368	56

