

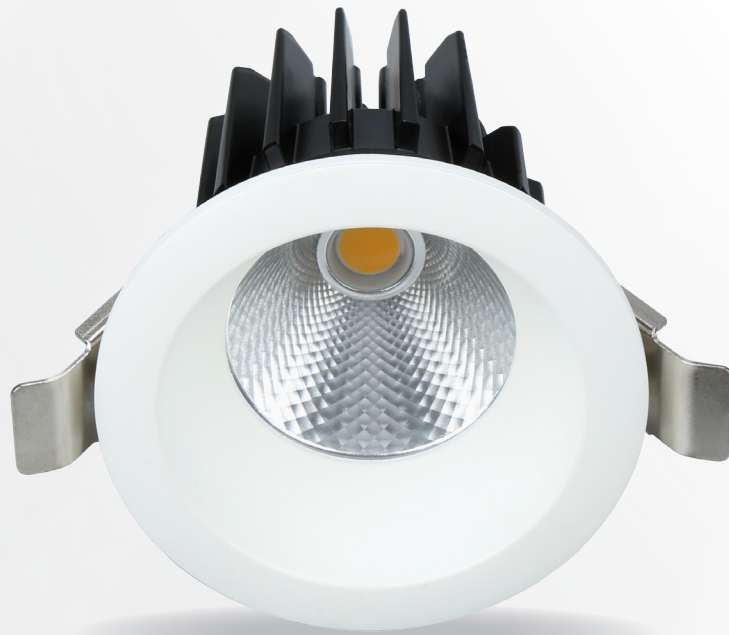

UPSHINE®



# Technical Application Guide for UP-SHINE LED Downlight

UP-DL88-2.5-10W

UP-DL88-2.5-10W-D

# Introduction

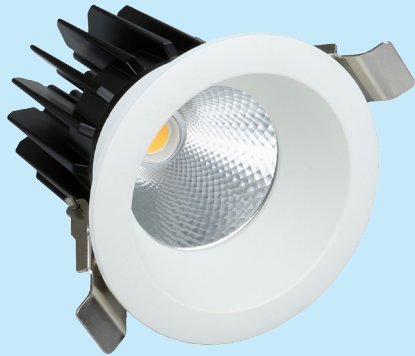

DL88 COB downlight is unique designed with reflector and COB high power LED chip. ADC12 Aluminum profile provides excellent thermal dissipation. Short heatsink designed for any ceiling installations. Isolated driver solution both in dimmable and non-dimmable version achieves great dimming compatibility with worldwide brand dimmers.

- Up to 70% energy saving compared to standard CFL
- Long lifetime of 50,000 hours
- Triac dim, 0-10V dim, DALI dim
- 24°/60° beam angle
- 68-75mm cutout
- CCT: 2700K 3000K 4000K 5000K
- No UV/IR light
- Environment friendly, without Mercury or any other hazardous substances

## Application notes

- IP20 for indoor use only
- Professional electrician for installation only
- Switch off before installation
- Do not touch when in use
- Keep away from hot steam and corrosive gas

## Application Areas

It is designed for general lighting applications in office, supermarket, shop, school, hotel, etc. It is also widely used for public areas, such as stairway, lobby, reception, corridors etc.

## Certificate

CE RoHS SAA



# Product Information

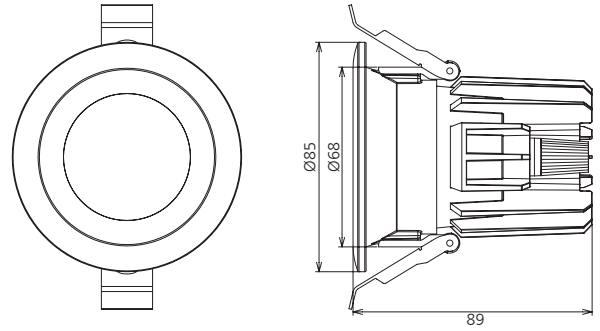

## Technical Specifications

Model	Voltage	Power	Power Factor	Lumen (±5%)	CCT	Beam angle	Lifespan	CRI	Dimmable	Dimension
UP-DL88-2.5-10W	AC230V	10W	≥0.9	750	2700K	24°/60°	50,000h	≥80	No	Ø85*89mm cutout 68-75mm
				820	3000K					
				860	4000K					
				840	5000K					
UP-DL88-2.5-10W-D	AC230V	10W	≥0.9	700	2700K	24°/60°	50,000h	≥80	Yes	Ø85*89mm cutout 68-75mm
				780	3000K					
				820	4000K					
				800	5000K					

## Driver data Sheet

Driver data	DIM	Non dim
Input rated Voltage	AC230V	AC230V
Frequency	50Hz	50/60Hz
Input Voltage	AC200-240V	AC200-240V
Efficiency	≥80%	≥83%
Total load Wattage	10W±1W	10W±1W
Power Factor	≥0.9	≥0.9
Rated input current	≤0.06A	≤0.06A
Full load output Voltage	DC23-40V	DC28-40V
Rated output current	220mA	230mA
Output current range	220mA±5%	230mA±5%
Power tolerance	±5%	±5%
Current output tolerance	±5%	±5%
Dimming range	8%-100%	—
Dimmer	Triac dimmers	—
Short circuit protection	PASS	PASS
Over voltage protection	PASS	PASS
Over temperature protection	PASS	PASS
THD	≤20%	≤20%
Withstand voltage	AC3750V	AC3750V

## Fixture Compatibility

Rated Wattage	Electrical Classification	Ingress Protection	Operating Temp	Operating Humidity	Storage Temp
10W	II	IP20	-20°C~45°C	0~90%	-20°C~65°C

# Spectral Distribution

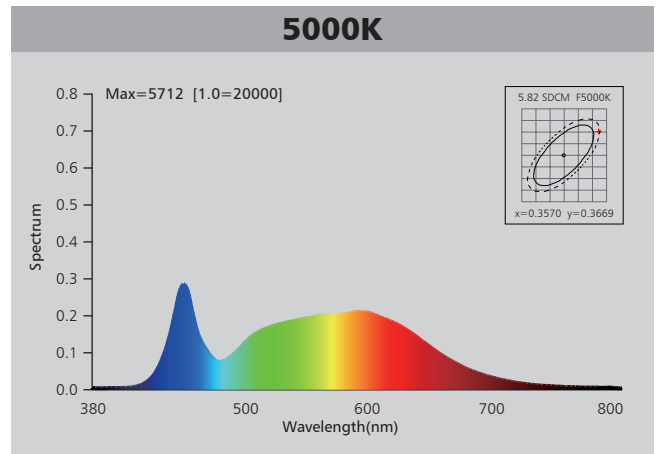
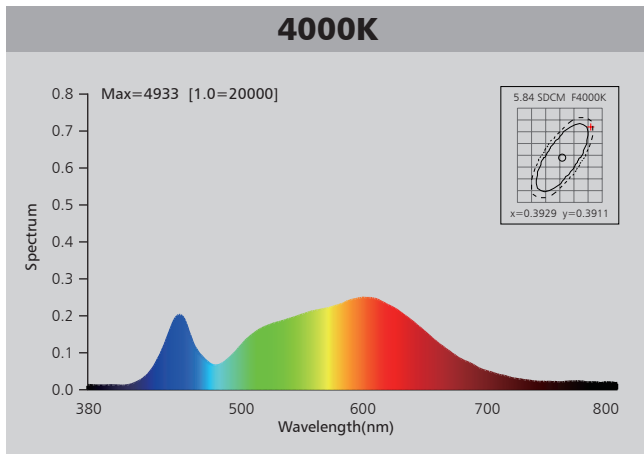
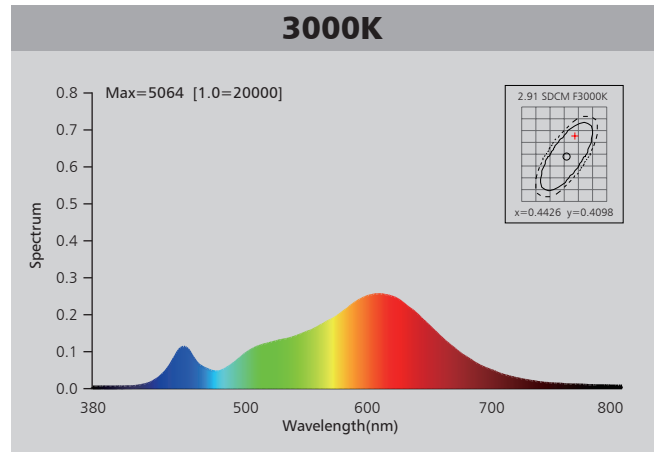
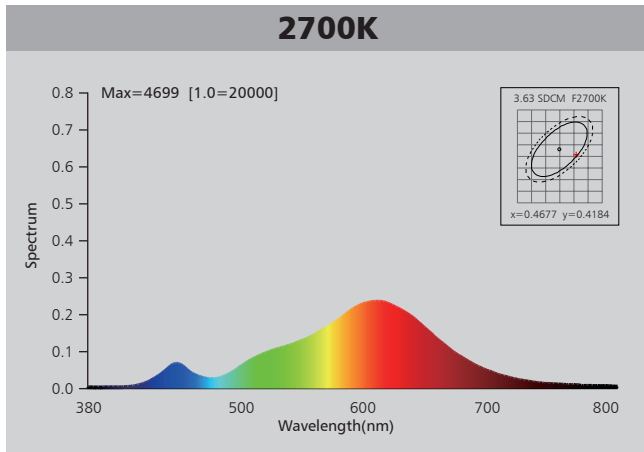

# Photometric Diagram

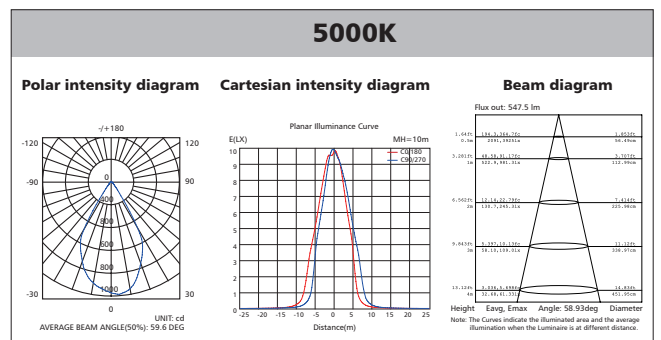
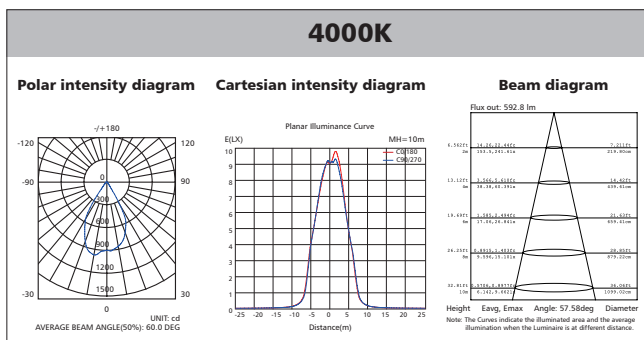
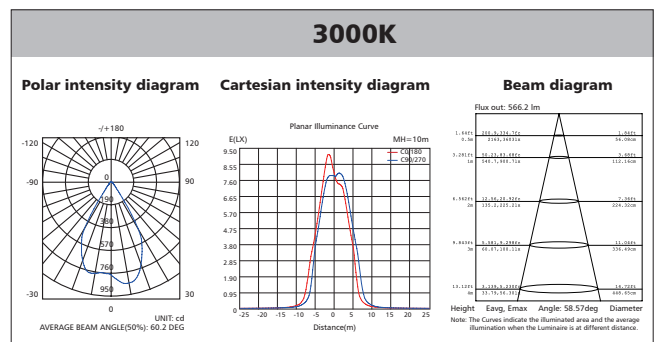
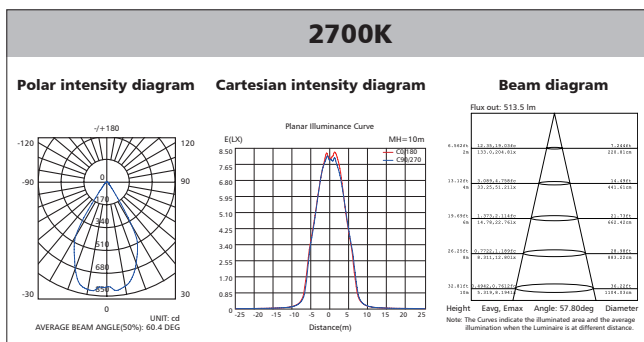

# Polar Diagram Comparison

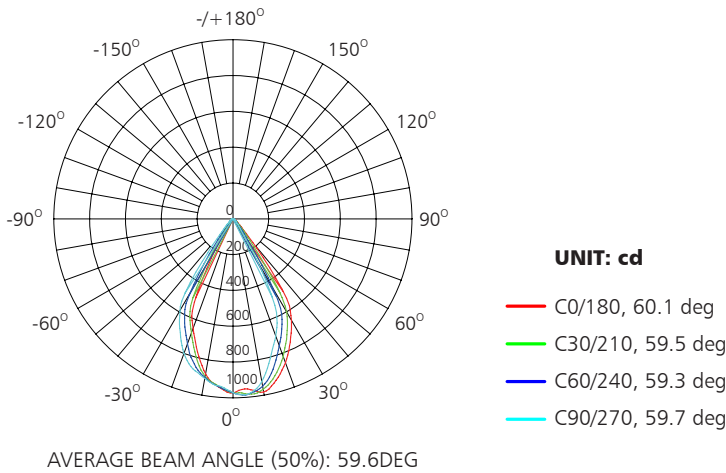

# Driver lifetime & LED light decay rate

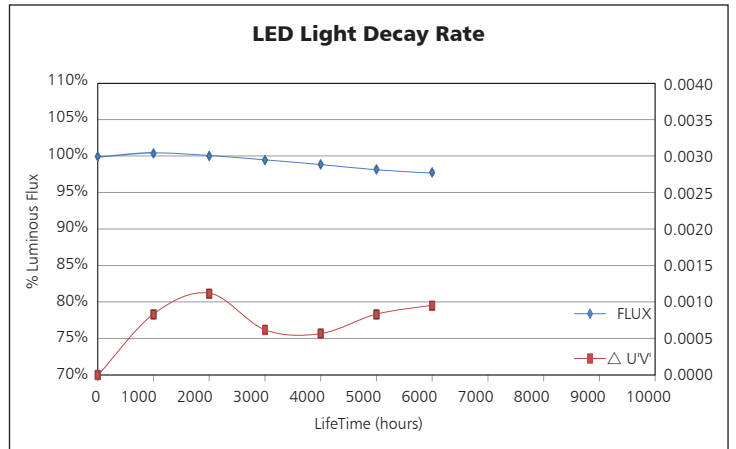
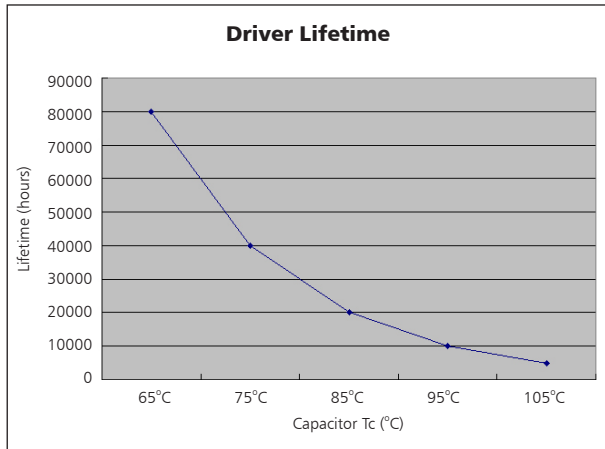

# Temperature

- The testing is operated at 25°C
- The lifetime of capacitor, minimum of 5,000 hours if operated at 105°C, will be doubled whenever the temperature drops 10°C
- The highest withstand temperature of IC, MOS could be 120°C
- The highest withstand temperature of LED junction temperature is 150°C

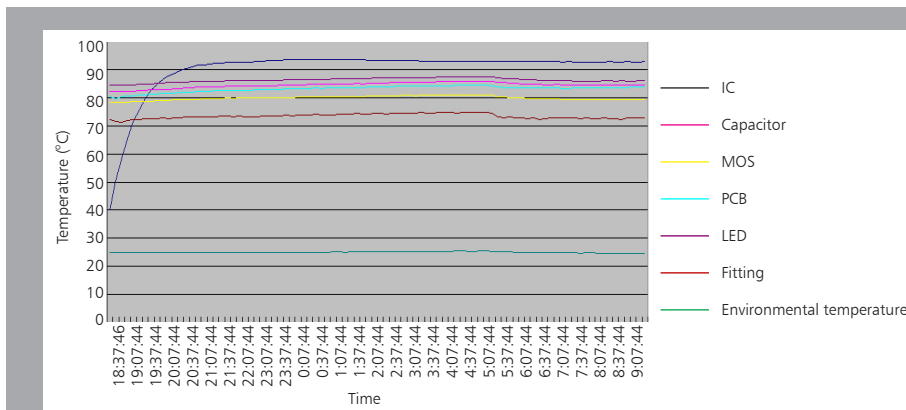

The driver lifespan is based on capacitor working temperature.

# Installation

Install requirements	
A-gap above the fitting	25mm
B-gap to the building material	25mm
C-gap to the thermal insulation	25mm

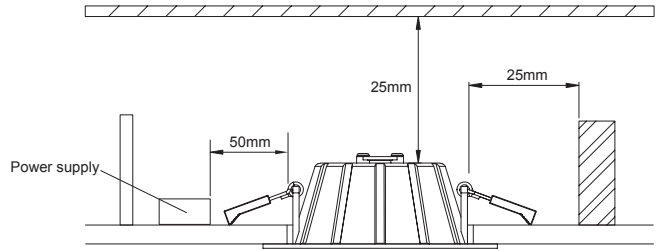

1. Open a hole according to the cutout size of led downlight.

2. Use screw-driver to open the driver terminal cover, feed the main AC wire L. N. in terminal block respectively, then fix the cover back.

3. Connect the downlight with driver, hold back the spring clip then push the downlight into the hole.

4. Make sure the downlight fixed tightly in ceiling, turn on the power (Fig 1).

# Packaging Information

	SIZE(CM)	N.W/pc (KGS)	G.W.(KGS)	Q'TY(PCS)
Carton	48*36.5*27	0.27	10	24

	CTNS	Q'TY(PCS)	VOLUME(CBM)
20" standard container	570	13680	28
40" standard container	1150	27600	56

