



UPSHINE®



Technical Application
Guide for UP SHINE
LED Downlight
UP-DL63-2.5-8W

Introduction

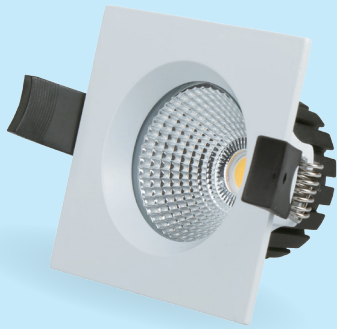

Up-shine Mini downlight is specially designed for European market with standard cutout size of 70mm. 24°/36°/60° beam angle provided, applicable for various lighting effect. Smart optical design with combination of COB LED and PC reflector creates the most comfortable lighting environment. Waterproof structural design, IP54 protection grade, ideally for damp locations.

- Up to 70% energy saving compared to standard CFL
- Long lifetime of 40,000 hours
- Triac dim
- 24°/36°/60° wide beam angle
- 68-74mm cutout
- CCT: 2700K 3000K
4000K 5000K
- No UV/IR light
- Environment friendly, without Mercury or any other hazardous substances

Application notes

- IP54 for indoor use only
- Professional electrician for installation only
- Switch off before installation
- Do not touch when in use
- Keep away from hot steam and corrosive gas

Application Areas

It is designed for general lighting applications in office, supermarket, shop, school, hotel, etc. It is also widely used for public areas, such as stairway, lobby, reception, corridors etc.

Certificate

CE RoHS SAA



Product Information

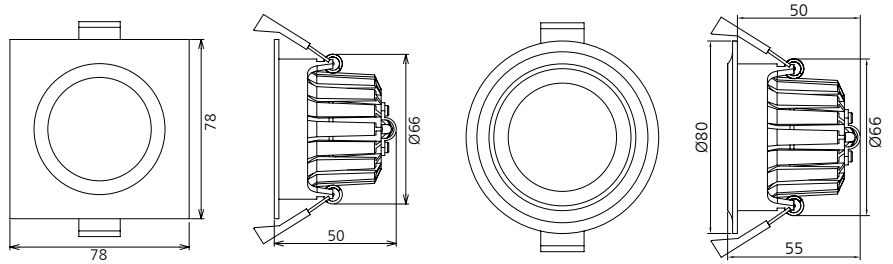

Technical Specifications

Model	Voltage	Power	Power Factor	Lumen (±5%)	Beam angle	CCT	Lifespan	CRI	Dimmable	Dimension
UP-DL63-2.5-8W	230V	8W	≥0.9	530	24°/36°/60°	2700K	40000h	≥80	No	78*78*50mm / Ø80*55mm cutout 68-74mm
UP-DL63-2.5-8W	230V	8W	≥0.9	560	24°/36°/60°	3000K	40000h	≥80	No	78*78*50mm / Ø80*55mm cutout 68-74mm
UP-DL63-2.5-8W	230V	8W	≥0.9	570	24°/36°/60°	4000K	40000h	≥80	No	78*78*50mm / Ø80*55mm cutout 68-74mm
UP-DL63-2.5-8W	230V	8W	≥0.9	590	24°/36°/60°	5000K	40000h	≥80	No	78*78*50mm / Ø80*55mm cutout 68-74mm
UP-DL63-2.5-8W-D	230V	8W	≥0.9	510	24°/36°/60°	2700K	40000h	≥80	Yes	78*78*50mm / Ø80*55mm cutout 68-74mm
UP-DL63-2.5-8W-D	230V	8W	≥0.9	520	24°/36°/60°	3000K	40000h	≥80	Yes	78*78*50mm / Ø80*55mm cutout 68-74mm
UP-DL63-2.5-8W-D	230V	8W	≥0.9	530	24°/36°/60°	4000K	40000h	≥80	Yes	78*78*50mm / Ø80*55mm cutout 68-74mm
UP-DL63-2.5-8W-D	230V	8W	≥0.9	560	24°/36°/60°	5000K	40000h	≥80	Yes	78*78*50mm / Ø80*55mm cutout 68-74mm

Driver data Sheet

Driver data	DIM	Non dim
Input rated Voltage	AC230V	AC230V
Frequency	50Hz	50Hz
Input Voltage	AC200-240V	AC200-240V
Efficiency	≥73%	≥81%
Total load Wattage	8W±0.5W	8W±0.5W
Power Factor	≥0.9	≥0.9
Rated input current	≤0.05A	≤0.05A
Full load output Voltage	DC33-38V	DC33-38V
Rated output current	170mA	190mA
Output current range	170mA±5%	190mA±5%
Power tolerance	±5%	±5%
Current output tolerance	±5%	±5%
Dimming range	8%-100%	—
Dimmer	Triac dimmers	—
Short circuit protection	PASS	PASS
Over voltage protection	PASS	PASS
Over temperature protection	PASS	PASS
Withstand voltage	AC3750V	AC3750V

Fixture Compatibility

Rated Wattage	Electrical Classification	Ingress Protection	Operating Temp	Operating Humidity	Storage Temp
8W	II	IP54	-20°C~45°C	0~90%	-20°C~65°C

Spectral Distribution

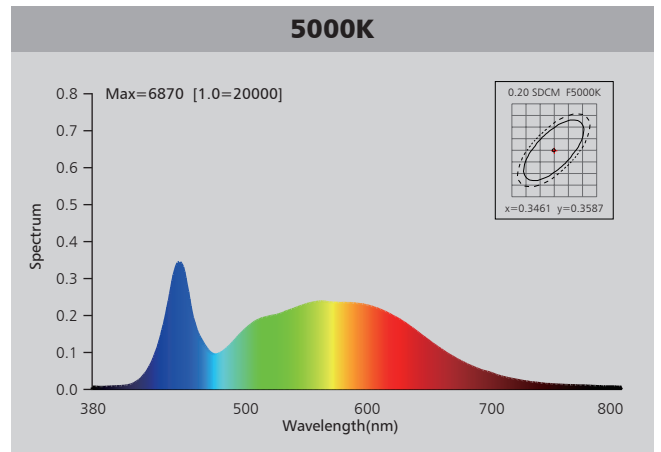
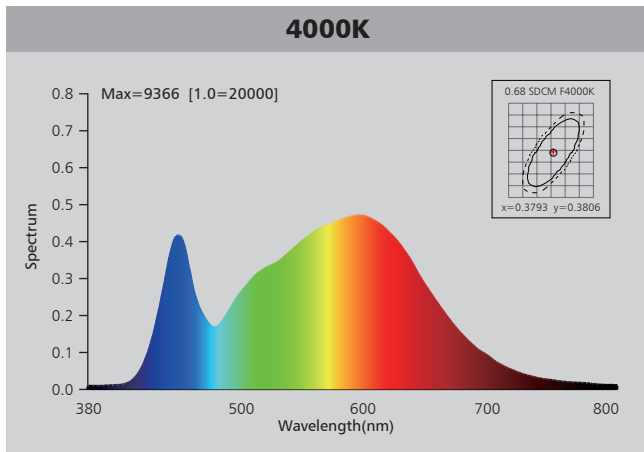
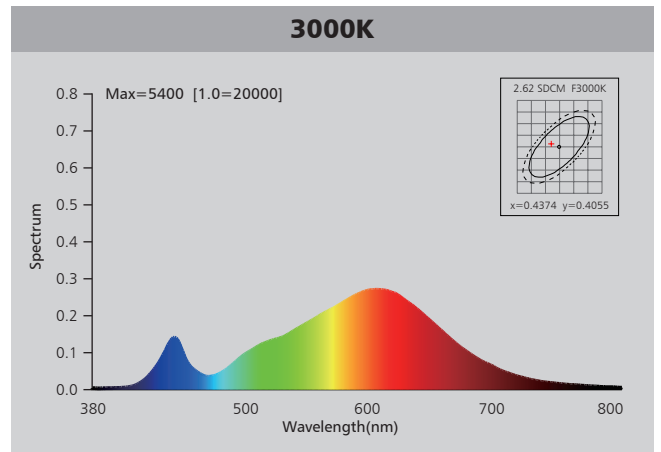
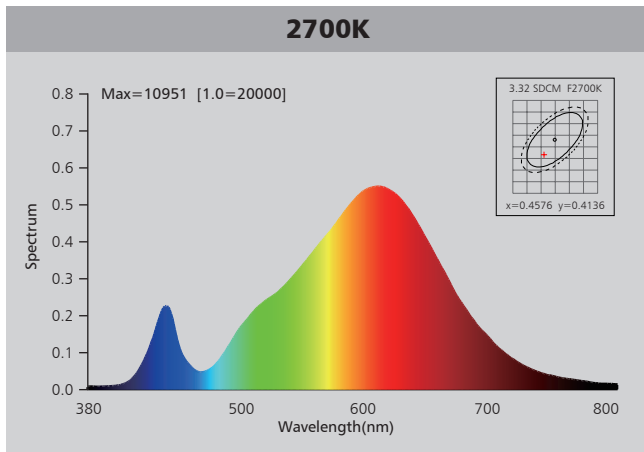

Photometric Diagram

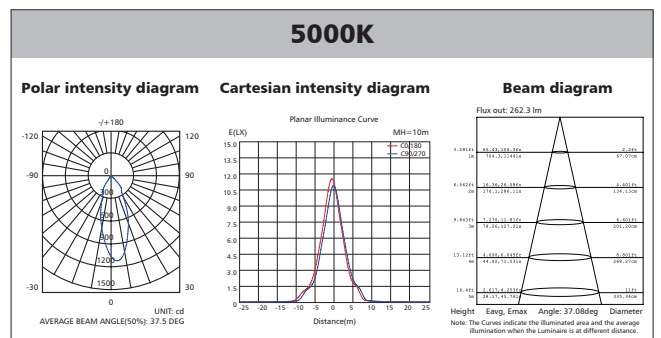
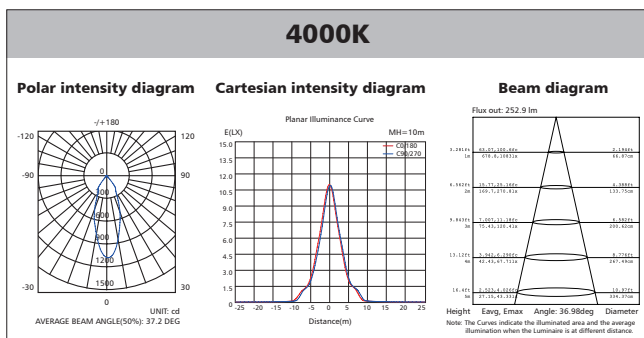
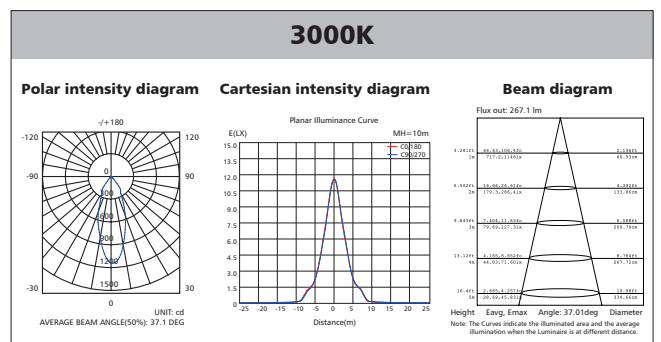
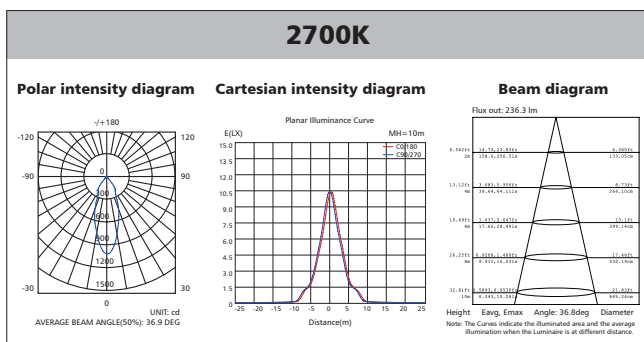

Polar Diagram Comparison

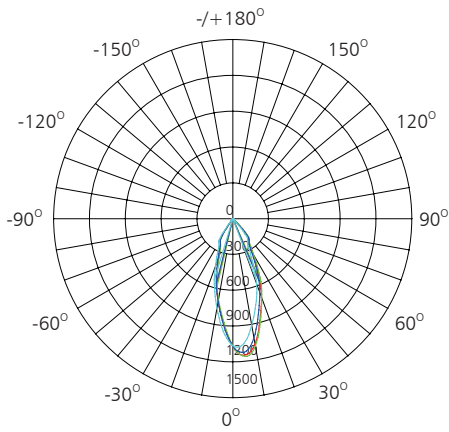

UNIT: cd

- C0/180, 37.5 deg
- C30/210, 37.2 deg
- C60/240, 37.5 deg
- C90/270, 38.0 deg

AVERAGE BEAM ANGLE (50%): 37.5 DEG



Driver lifetime & LED light decay rate

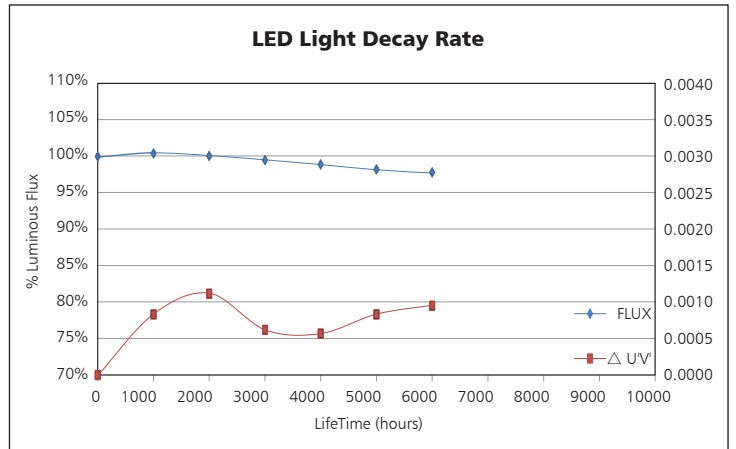
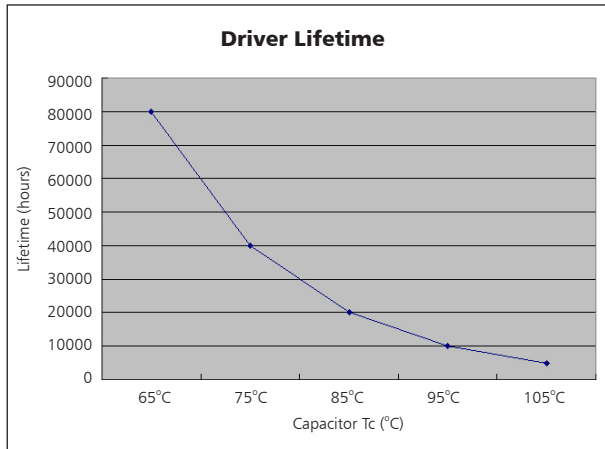

Temperature

- The testing is operated at 25°C
- The lifetime of capacitor, minimum of 5,000 hours if operated at 105°C, will be doubled whenever the temperature drops 10°C
- The highest withstand temperature of IC, MOS could be 120°C
- The highest withstand temperature of LED junction temperature is 150°C

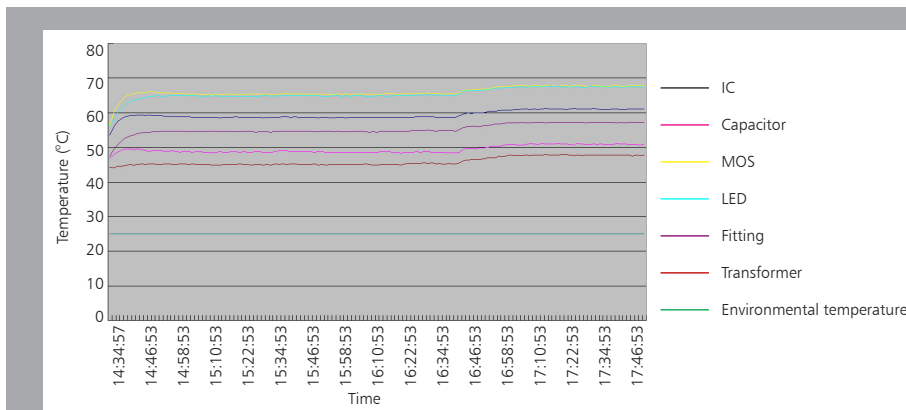

The driver lifespan is based on capacitor working temperature.

Installation

Install requirements	
A-gap above the fitting	25mm
B-gap to the building material	25mm
C-gap to the thermal insulation	25mm

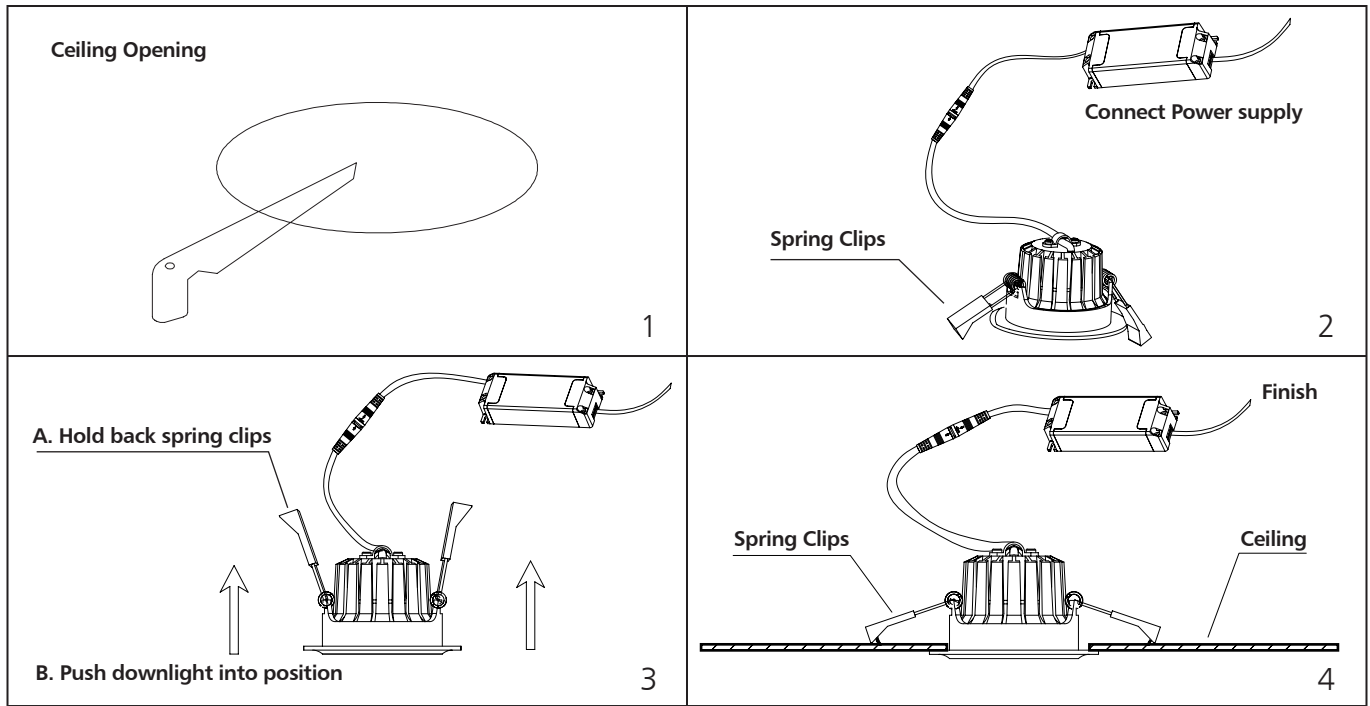
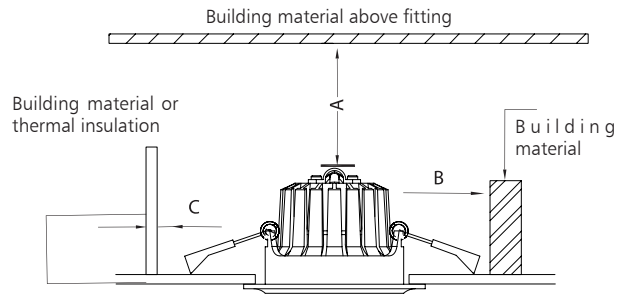

Packaging Information

	SIZE(CM)	N.W/pc (KGS)	G.W.(KGS)	Q'TY(PCs)
Carton	46*46*29.5	0.28	15	48

	CTNS	Q'TY(PCs)	VOLUME(CBM)
20" standard container	440	21120	28
40" standard container	880	42240	56

