



UPSHINE®



Technical Application Guide for UP-SHINE LED Downlight

UP-DL54-3-10W-P3



Introduction

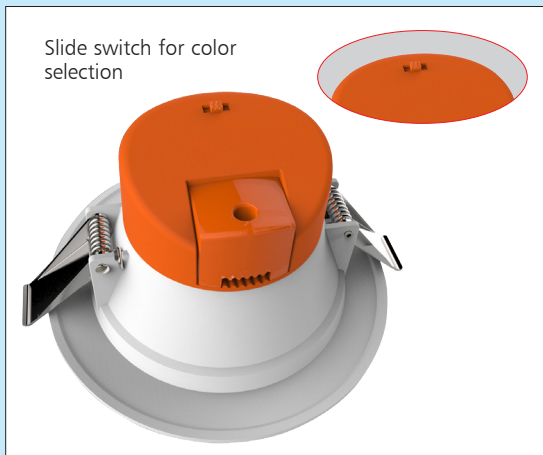
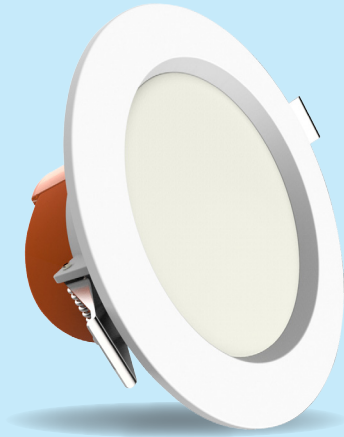

Up-shine SMD LED Down light adopts high lumen SMD LED, PC diffuser with even light output. Plastic coated aluminum housing with internal driver design; it is our most economical and practical downlight version. Dimmable driver shares great popularity by the excellent dimming effect.

- Up to 70% energy saving compared to standard CFL
- Long lifetime of 40,000 hours
- Dimmable when using triac dimmer
- 90° wide beam angle
- 90-95mm cutout
- CCT: 3000K 4000K 5700K
- No UV/IR light
- Environment friendly, without Mercury or any other hazardous substances

Application notes

- IP54 only for the LED cover, IP40 for other part
- Professional electrician for installation only
- Switch off before installation
- Do not touch when in use
- Keep away from hot steam and corrosive gas

Application Areas

It is designed for general lighting applications in office, supermarket, shop, school, hotel, etc. It is also widely used for public areas, such as stairway, lobby, reception, corridors etc.

Certificate

CE RoHS SAA



Product Information

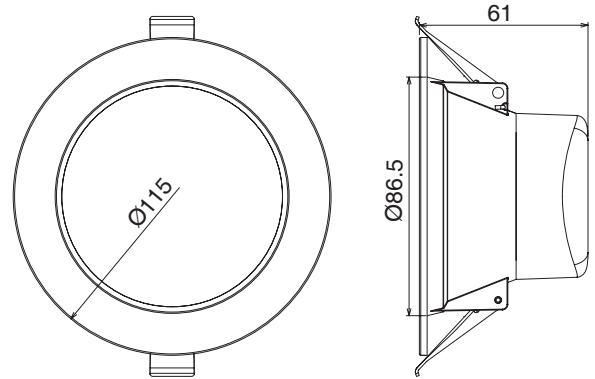

Technical Specifications

Model	Voltage	Power	Power Factor	Lumen (±5%)	Beam angle	CCT	Lifespan	CRI	Dimmable	Dimension
UP-DL54-3-10W-P3	AC230V	10W	0.9	800	90°	3000K	40000h	≥80	Yes	Ø115*61mm cutout 90-95mm
UP-DL54-3-10W-P3	AC230V	10W	0.9	940	90°	4000K	40000h	≥80	Yes	Ø115*61mm cutout 90-95mm
UP-DL54-3-10W-P3	AC230V	10W	0.9	870	90°	5700K	40000h	≥80	Yes	Ø115*61mm cutout 90-95mm

Driver data Sheet

Driver data	DIM
Input rated Voltage	AC230V
Frequency	50Hz
Input Voltage	AC200-240V
Efficiency	≥83%
Total load Wattage	10W±1W
Power Factor	0.9
Rated input current	≤0.06A
Full load output Voltage	65-75V
Rated output current	120mA
Output current range	120mA±5%
Power tolerance	±5%
Current output tolerance	±5%
Dimming range	8%-100%
Dimmer	Triac dimmers
Short circuit protection	PASS
Over voltage protection	PASS
Over temperature protection	PASS
Withstand voltage	—

Fixture Compatibility

Rated Wattage	Electrical Classification	Ingress Protection	Operating Temp	Operating Humidity	Storage Temp
10W	II	IP40/IP54	-20°C~45°C	0~90%	-20°C~65°C

Spectral Distribution

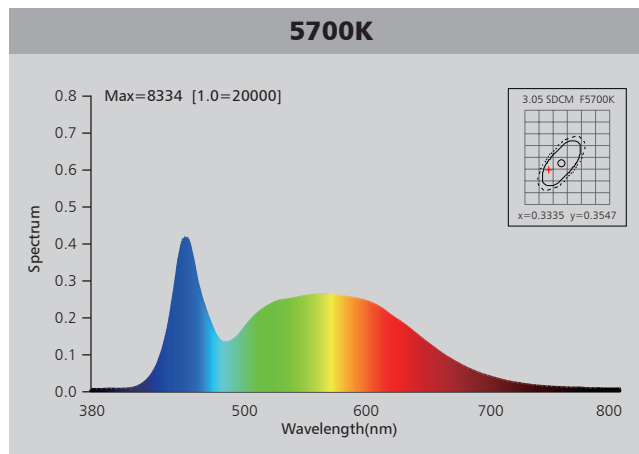
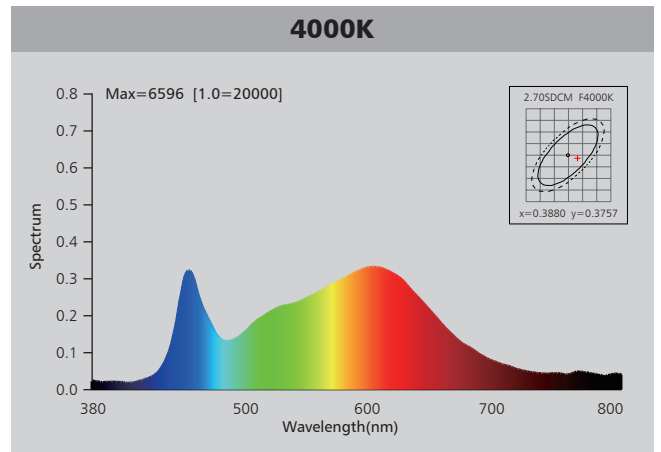
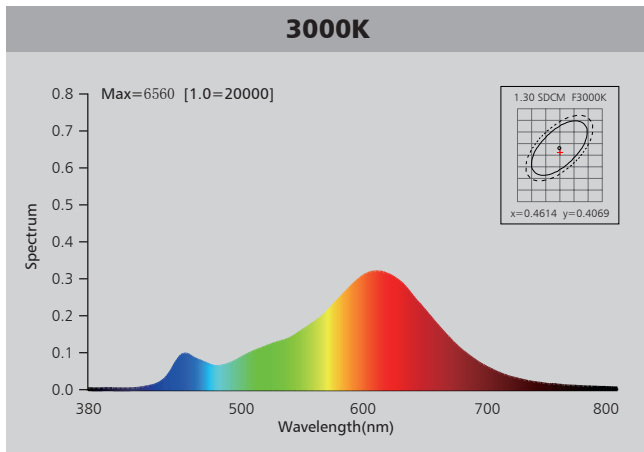

Photometric Diagram

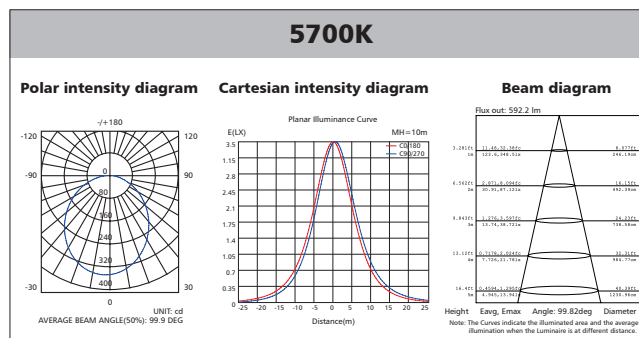
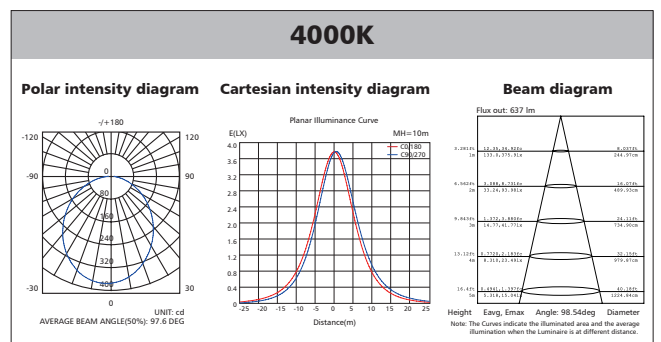
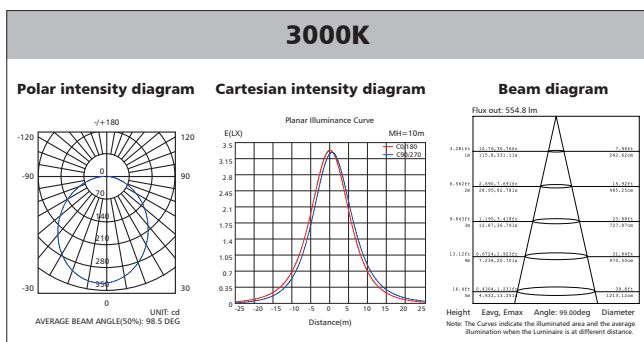

Polar Diagram Comparison

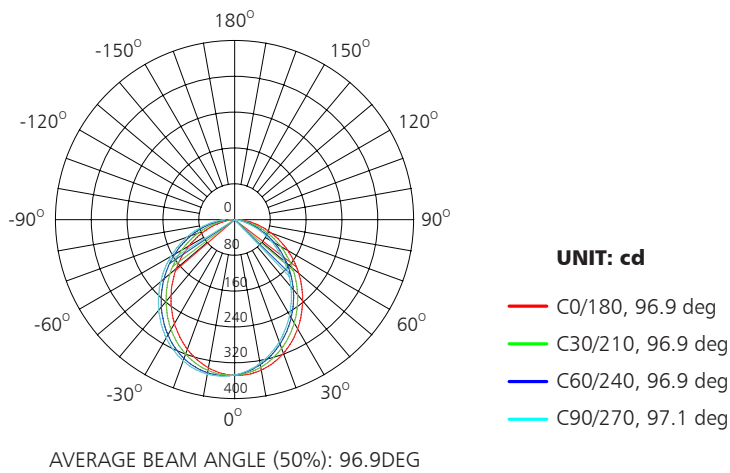

Driver lifetime & LED light decay rate

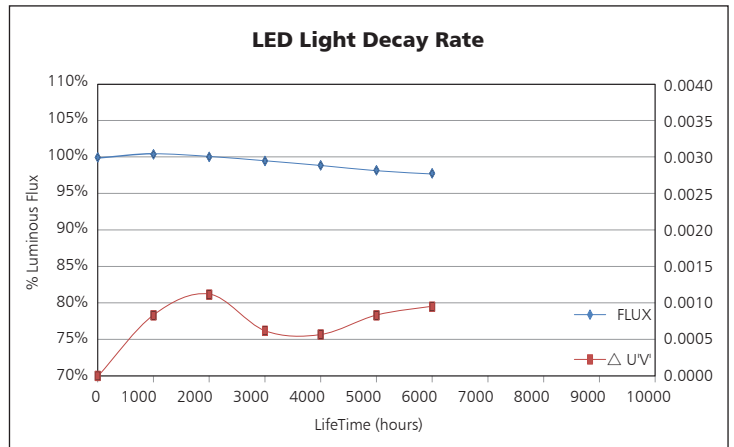
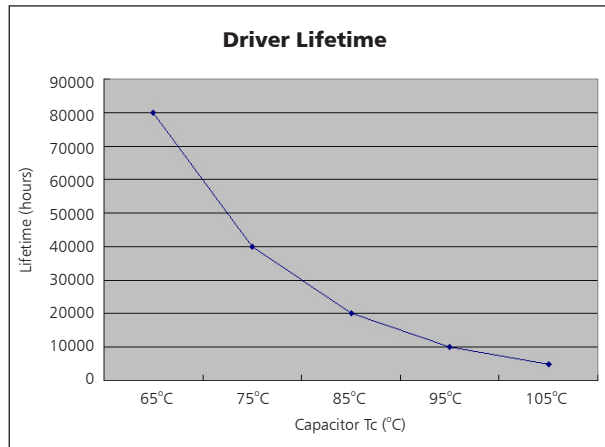

Temperature

- The testing is operated at 25°C
- The lifetime of capacitor, minimum of 5,000 hours if operated at 105°C, will be doubled whenever the temperature drops 10°C
- The highest withstand temperature of IC, MOS could be 120°C
- The highest withstand temperature of LED junction temperature is 150°C

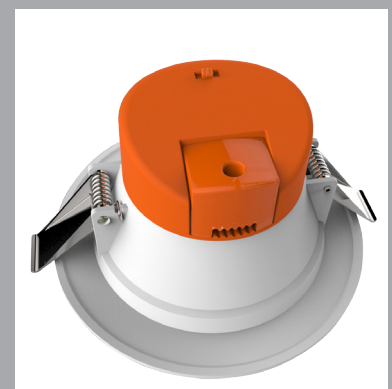
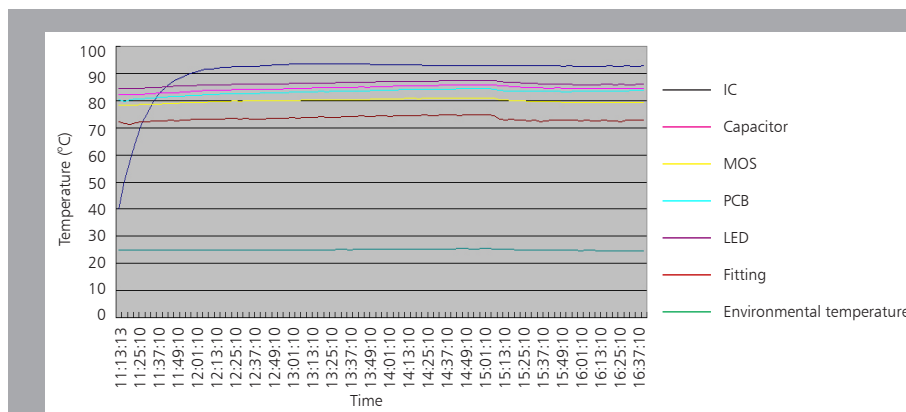

The driver lifespan is based on capacitor working temperature.

Installation

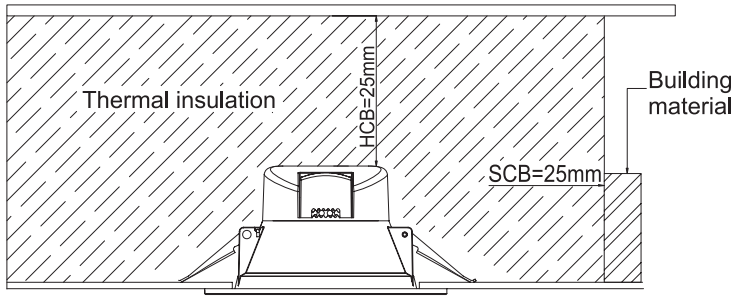

<p>Ceiling Opening</p> <p>1</p>	<p>Loosen the screw and take off the cover, connect the wire to the wiring terminals, put the cover back and tighten the screw.</p> <p>2</p>
<p>A. Hold back spring clips</p> <p>B. Push downlight into position</p> <p>3</p>	<p>Spring Clips</p> <p>Ceiling</p> <p>4</p>

Packaging Information

	SIZE(CM)	N.W/pc (KGS)	G.W.(KGS)	Q'TY(PCS)
Carton	39*26.5*37.5	0.2	8.4	30

	CTNS	Q'TY(PCS)	VOLUME(CBM)
20" standard container	704	21120	28
40" standard container	1408	42240	56

