



UPSHINE®



Technical Application
Guide for UP-SHINE
LED Downlight
UP-DL54-3-10W-B1



Introduction



Up-shine LED downlight with bluetooth wireless control system offers consumers an easy, convenient, and cost-effective way to personalize and control a home lighting system. The control system use bluetooth technology to connect lights throughout an entire home via a free APP on a Bluetooth-enabled smart device. No wires, no router, no remote, and no Wi-Fi signal is needed. A user can simply control downlight from any Bluetooth-enabled phone or tablet and then personalize it to meet any family or lifestyle needs. The system also allows multiple devices to be connected simultaneously so the entire family can stay connected.

- Up to 80% energy saving compared to standard CFL
- Long lifetime of 40,000 hours
- 90° wide beam angle
- Ø90-95mm cutout
- Bluetooth
- No UV/IR light
- Environment friendly, without Mercury or any other hazardous substances
- Internal Driver

Application notes

- IP54 only for the LED cover, IP40 for other part
- Professional electrician for installation only
- Switch off before installation
- Do not touch when in use
- Keep away from hot steam and corrosive gas

Application Areas

It is designed for general lighting applications in office, supermarket, shop, school, hotel, etc. It is also widely used for public areas, such as stairway, lobby, reception, corridors etc.

Certificates

CE RoHS SAA  Bluetooth®





GooglePlay

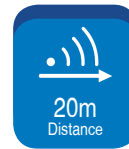
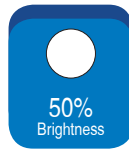
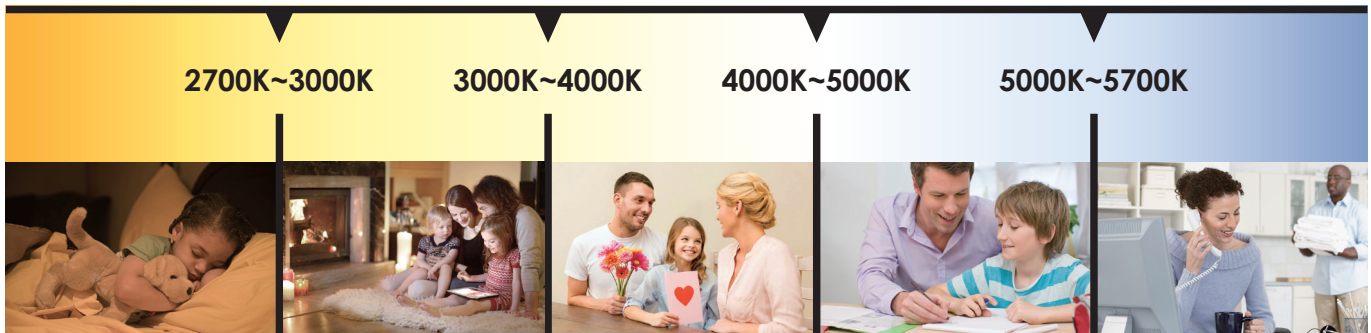

APP STORE

Bluetooth Intelligent Control



 **2700K~5700K Changeable** Creating fantastic atmosphere by flexible CCT changing between warm white, natural white and day light, the color changing items are controlled by smart phone APP



 **5%~100% Dimmable** Dimmable from 5%~100% brightness with timing and night lamp function, diversified scene setting, creating a humanized smart control system.



Product Information

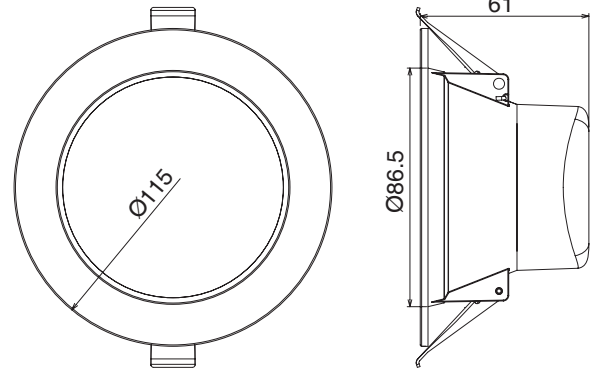

Technical Specifications

Model	Voltage	Power	Power Factor	Lumen (±5%)	Beam angle	CCT	Lifespan	CRI	Dimmable	Dimension
UP-DL54-3-10W-B1	AC230V	10W	0.9	800 940 870	90°	3000K 4000K 5700K	40000h	≥80	Yes	Ø115*61mm cutout 90-95mm

Driver data Sheet

Driver data	DIM
Input rated Voltage	AC230V
Frequency	50Hz
Input Voltage	AC200-240V
Efficiency	≥83%
Total load Wattage	10W±1W
Power Factor	0.9
Rated input current	≤0.06A
Full load output Voltage	65-75V
Rated output current	120mA
Output current range	120mA±5%
Power tolerance	±5%
Current output tolerance	±5%
Dimming range	5%-100%
Dimmer	Triac dimmers
Short circuit protection	PASS
Over voltage protection	PASS
Over temperature protection	PASS
Withstand voltage	—

Fixture Compatibility

Rated Wattage	Electrical Classification	Ingress Protection	Operating Temp	Operating Humidity	Storage Temp
10W	II	IP40 / IP54	-20°C~45°C	0~90%	-20°C~65°C

Spectral Distribution

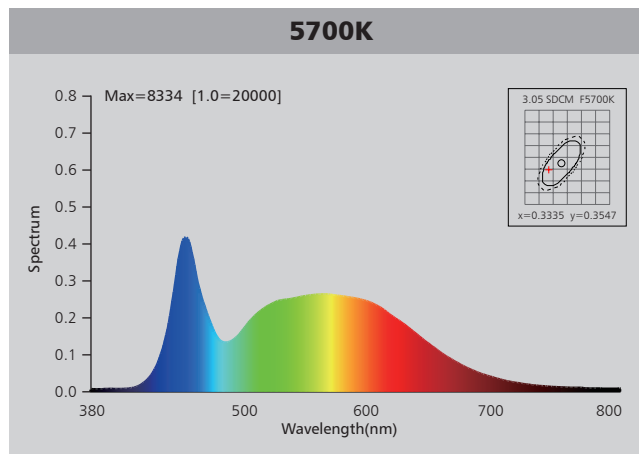
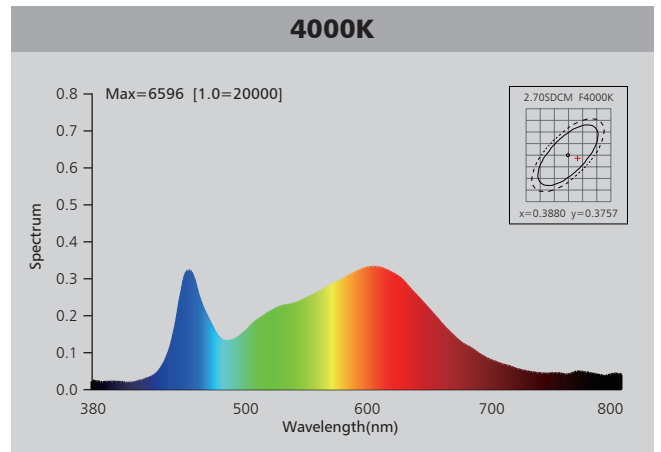
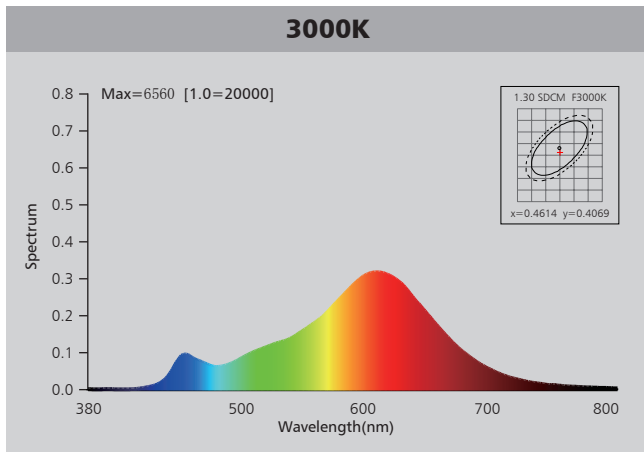

Photometric Diagram

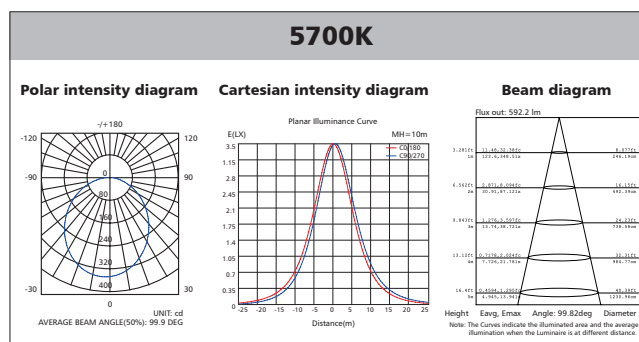
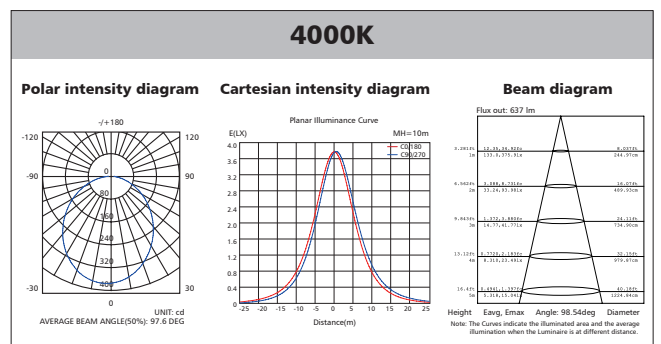
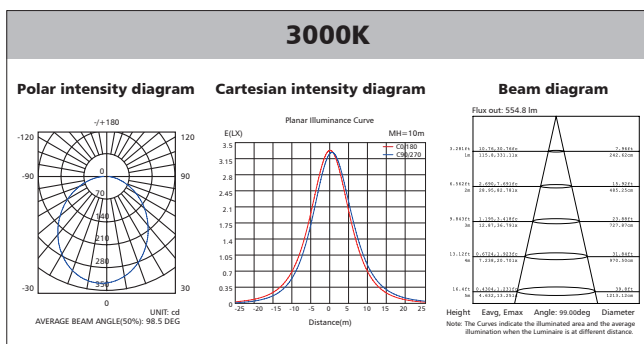

Polar Diagram Comparison

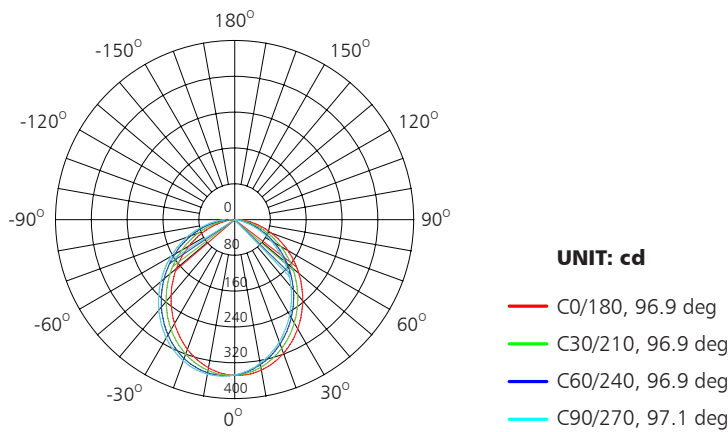

AVERAGE BEAM ANGLE (50%): 96.9DEG



Driver lifetime & LED light decay rate

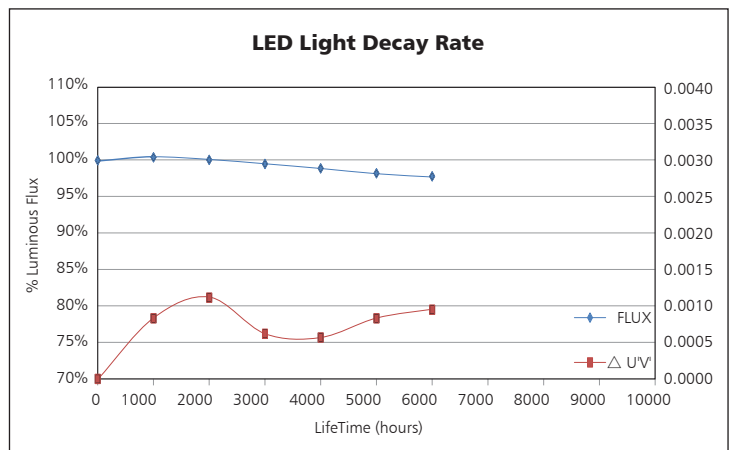
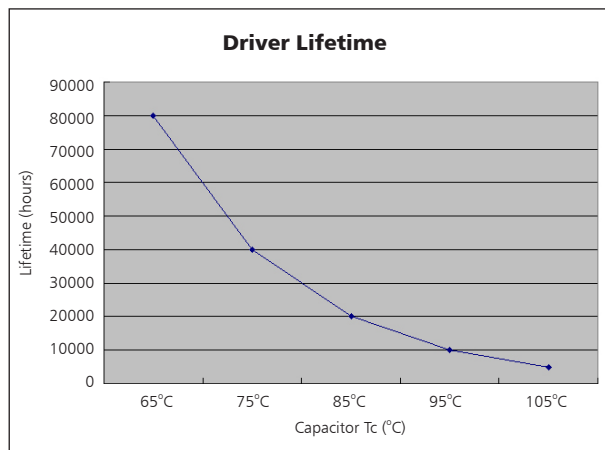

Temperature

- The testing is operated at 25°C
- The lifetime of capacitor, minimum of 5,000 hours if operated at 105°C, will be doubled whenever the temperature drops 10°C
- The highest withstand temperature of IC, MOS could be 120°C
- The highest withstand temperature of LED junction temperature is 150°C

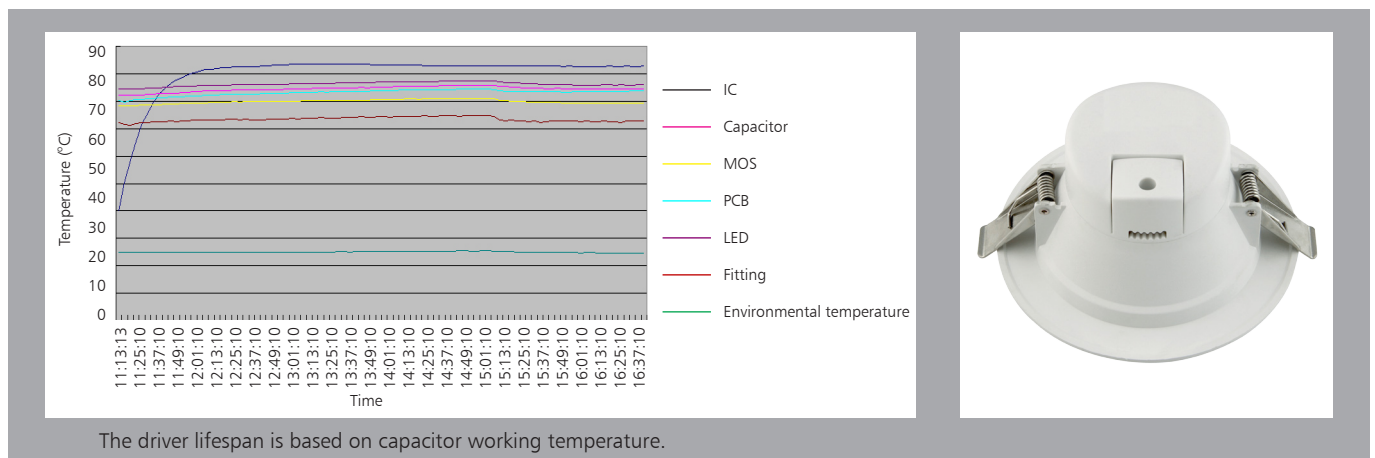

Installation

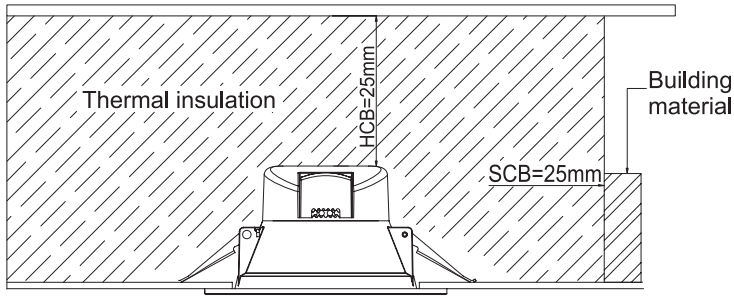

<p>Ceiling Opening</p> <p style="text-align: right;">1</p>	<p>Connect Power supply</p> <p style="text-align: right;">2</p>
<p>A. Hold back spring clips</p> <p>B. Push downlight into position</p> <p style="text-align: right;">3</p>	<p>Spring Clips</p> <p>Ceiling</p> <p style="text-align: right;">4</p>

Packaging Information

	SIZE(CM)	N.W/pc (KGS)	G.W.(KGS)	Q'TY(PCS)
Carton	39*26.5*37.5	0.25	9	30

	CTNS	Q'TY(PCS)	VOLUME(CBM)
20" standard container	704	21120	28
40" standard container	1408	42240	56

