



UPSHINE[®]



Technical Application
Guide for UP-SHINE
LED Downlight
UP-DL22-6-18W

Introduction



Up-shine COB downlight is unique designed with reflector and COB high power LED chip. ADC12 Aluminum profile provides excellent thermal dissipation. Short heatsink designed for any ceiling installations. Isolated driver solution both in dimmable and non-dimmable version achieves great dimming compatibility with worldwide brand dimmers.

- Up to 70% energy saving compared to standard CFL
- Long lifetime of 40,000 hours
- Triac dim, 0-10V dim, DALI dim
- 24°/36°/45°/60° wide beam angle
- 160-170mm cutout
- CCT: 3000K 4000K
5000K 5700K
- No UV/IR light
- Environment friendly, without Mercury or any other hazardous substances

Application notes

- IP20/IP44 for indoor use only
- Professional electrician for installation only
- Switch off before installation
- Do not touch when in use
- Keep away from hot steam and corrosive gas

Application Areas

It is designed for general lighting applications in office, supermarket, shop, school, hotel, etc. It is also widely used for public areas, such as stairway, lobby, reception, corridors etc.

Certificate

CE RoHS SAA



Product Information

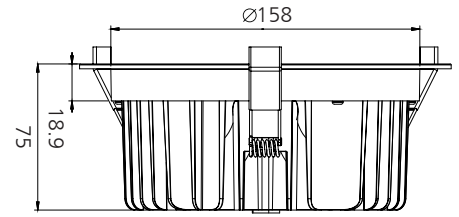
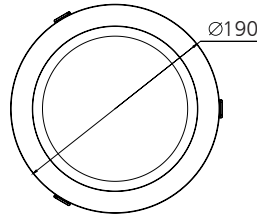

Technical Specifications

Model	Voltage	Power	Power Factor	Lumen (±5%)	Beam angle	CCT	Lifespan	CRI	Dimmable	Dimension
UP-DL22-6-18W	AC100-240V	18W	≥0.9	1310	24°/36°/45°/60°	3000K	40000h	≥80	No	Ø190*75mm cutout 160-170mm
				1370		4000K				
				1380		5000K				
				1390		5700K				
UP-DL22-6-18W-D	AC230V	18W	≥0.9	1260	24°/36°/45°/60°	3000K	40000h	≥80	Yes	Ø190*75mm cutout 160-170mm
				1320		4000K				
				1330		5000K				
				1370		5700K				

Driver data Sheet

Driver data	DIM	Non dim
Input rated Voltage	AC230V	AC100-240V
Frequency	50Hz	50/60Hz
Input Voltage	AC200-240V	AC85-265V
Efficiency	≥78%	≥86%
Total load Wattage	18W±1W	18W±1W
Power Factor	≥0.9	≥0.9
Rated input current	≤0.09A	≤0.2A
Full load output Voltage	DC29-33V	DC29-33V
Rated output current	450mA	500mA
Output current range	450mA±5%	500mA±5%
Power tolerance	±5%	±5%
Current output tolerance	±5%	±5%
Dimming range	8%-100%	——
Dimmer	Triac dimmers	——
Short circuit protection	PASS	PASS
Over voltage protection	PASS	PASS
Over temperature protection	PASS	PASS
Withstand voltage	AC3750V	AC3750V

Fixture Compatibility

Rated Wattage	Electrical Classification	Ingress Protection	Operating Temp	Operating Humidity	Storage Temp
18W	II	IP20/IP44	-20°C~45°C	0~90%	-20°C~65°C

Spectral Distribution

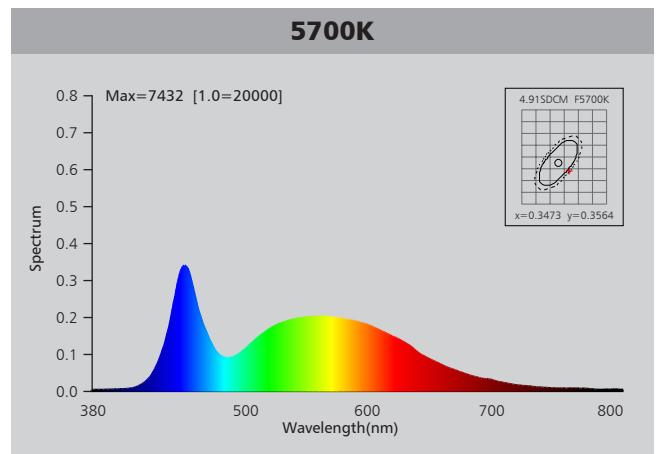
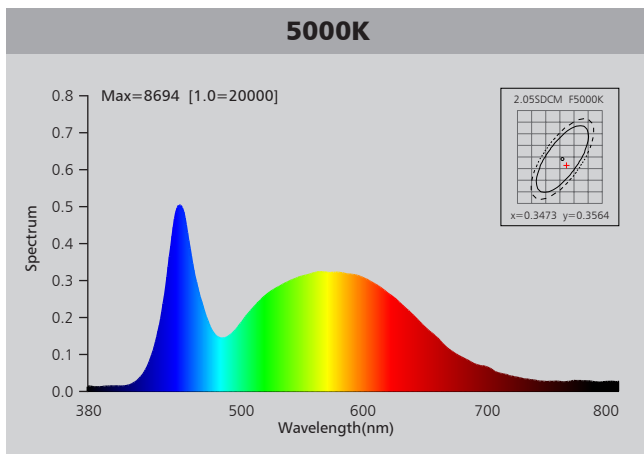
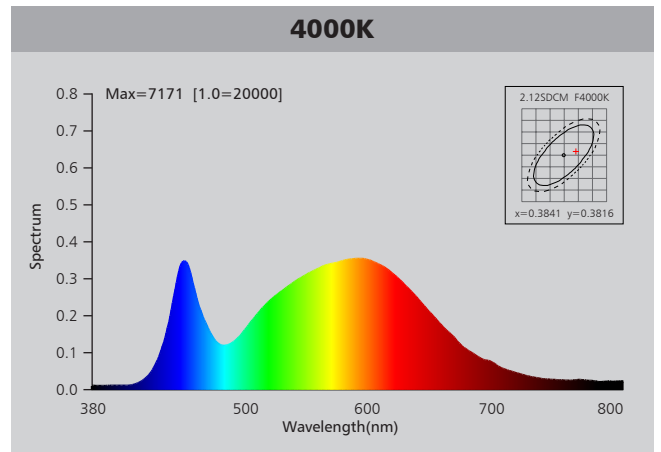
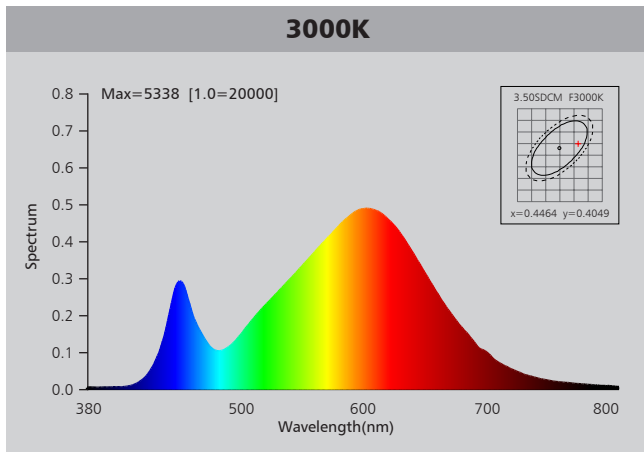

Photometric Diagram

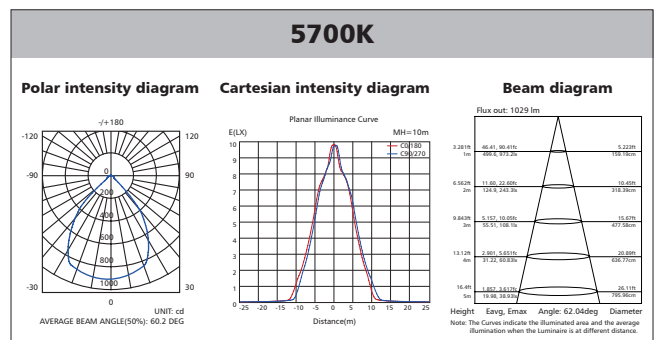
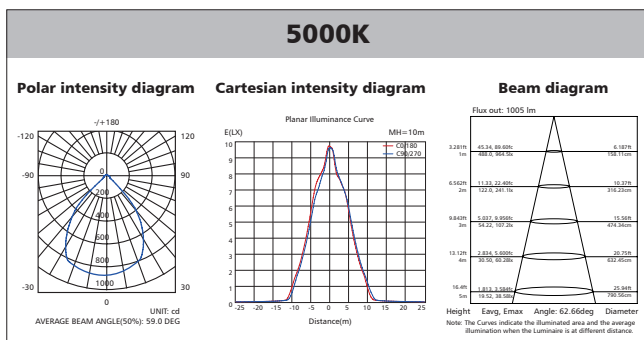
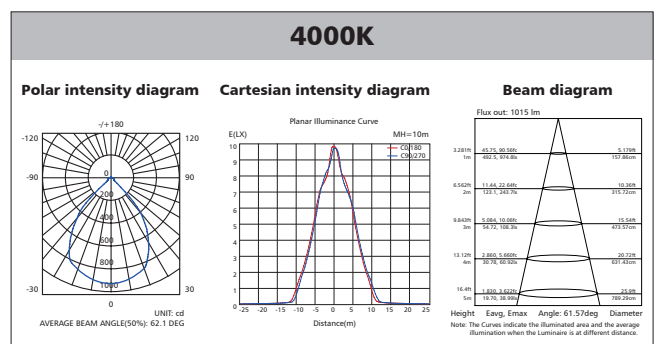
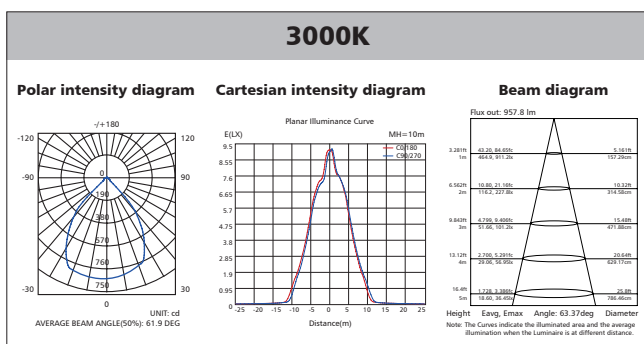

Polar Diagram Comparison

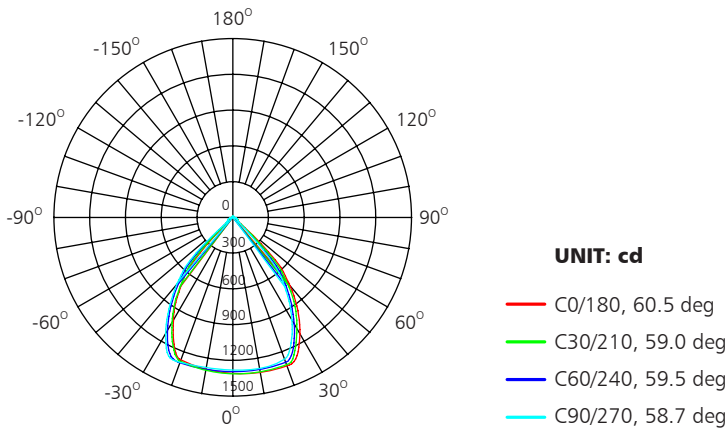

AVERAGE BEAM ANGLE (50%): 59.3DEG



Driver lifetime & LED light decay rate

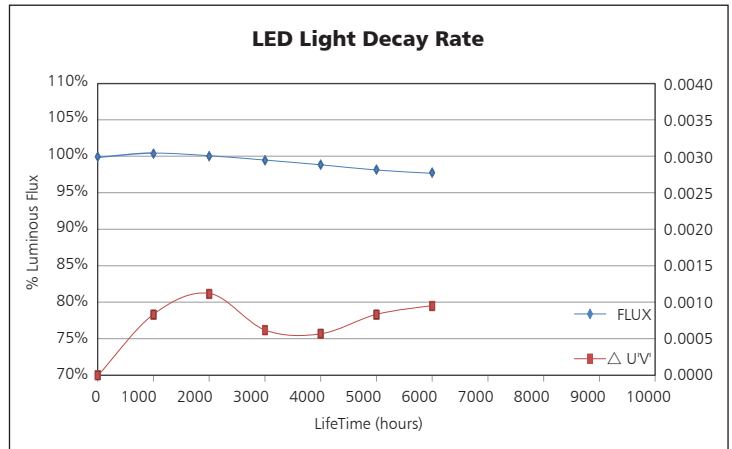
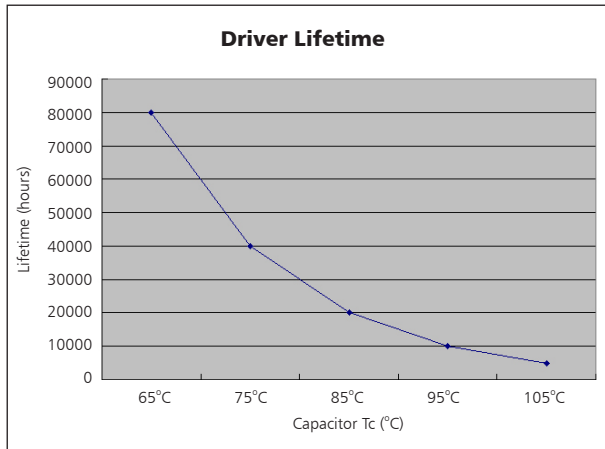

Temperature

- The testing is operated at 25°C
- The lifetime of capacitor, minimum of 5,000 hours if operated at 105°C, will be doubled whenever the temperature drops 10°C
- The highest withstand temperature of IC, MOS could be 120°C
- The highest withstand temperature of LED junction temperature is 150°C

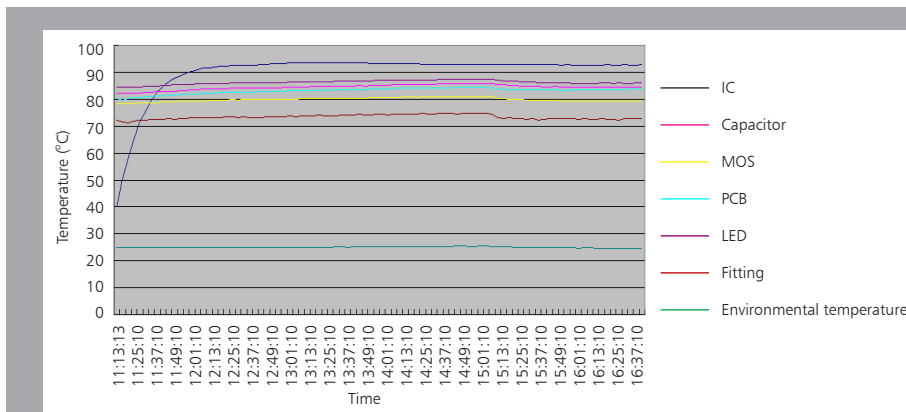

The driver lifespan is based on capacitor working temperature.

Installation

Install requirements	
A-gap above the fitting	25mm
B-gap to the building material	25mm
C-gap to the thermal insulation	25mm

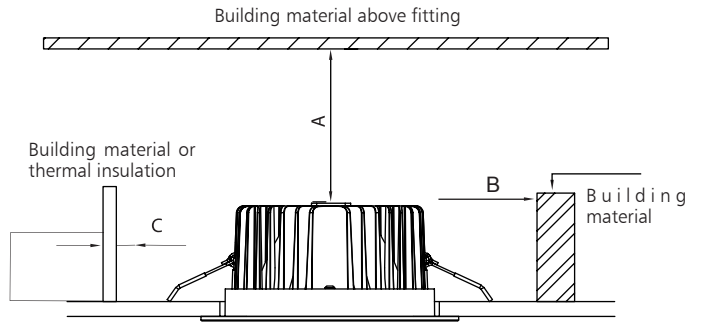

<p>Ceiling Opening Ø160-170mm</p> <p style="text-align: right;">1</p>	<p>Connect Power supply</p> <p style="text-align: right;">2</p>
<p>A. Hold back spring clips</p> <p>B. Push downlight into position</p> <p style="text-align: right;">3</p>	<p>Finish</p> <p style="text-align: right;">4</p>

Packaging Information

	SIZE(CM)	N.W/pc (KGS)	G.W.(KGS)	Q'TY(PCS)
Carton	66*46*20.5	0.95	13.9	12

	CTNS	Q'TY(PCS)	VOLUME(CBM)
20" standard container	440	5280	28
40" standard container	880	10560	56

