

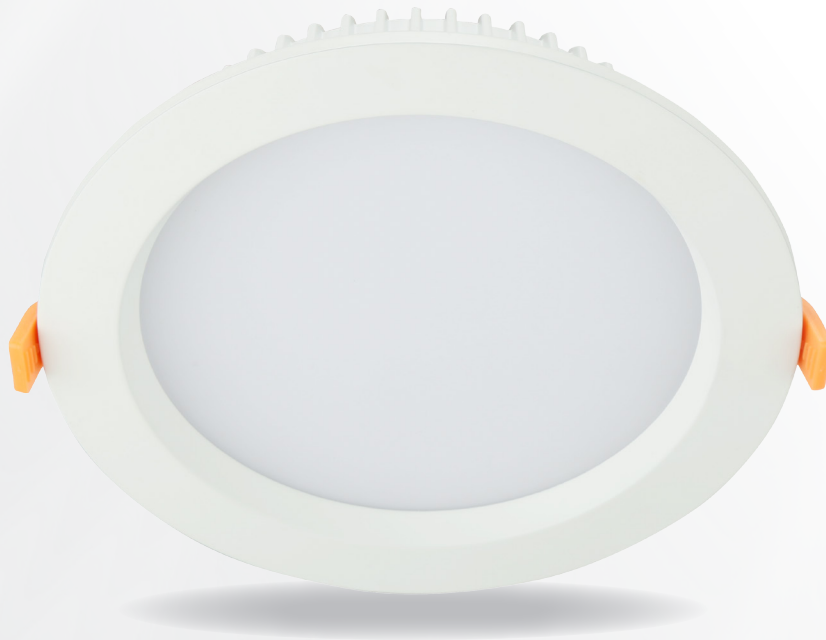

Up-shine[®] Lighting



Technical Application Guide for UP-SHINE LED Downlight

UP-DL110-6-25W

Introduction



Up-shine IP65 waterproof LED Down light DL110 model adopts high lumen SMD LED, which makes light effect reach 90-100lm/w, PMMA diffuser with even light output. Lamp body IP65 rating designed, can be widely used in indoor and outdoor applications. White, silver, chrome surface are available for customer's preference.

- Up to 70% energy saving compared to standard CFL
- Long lifetime of 40,000 hours
- 90° wide beam angle
- Ø175-185mm cutout
- CCT: 3000K 4000K
5000K 5700K
- No UV/IR light
- Environment friendly, without Mercury or any other hazardous substances

Application notes

- IP65 waterproof for indoor and outdoor use
- Professional electrician for installation only
- Switch off before installation
- Do not touch when in use
- Keep away from hot steam and corrosive gas

Application Areas

It is designed for general lighting applications in office, supermarket, shop, school, hotel, etc. It is also widely used for public areas, such as stairway, lobby, reception, corridors etc.

Certificate

CE RoHS



Product Information

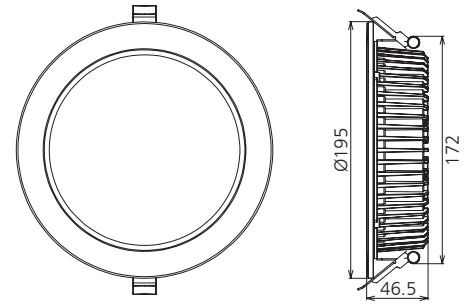

Technical Specifications

Model	Voltage	Power	Power Factor	Lumen (±5%)	Beam angle	CCT	Lifespan	CRI	Dimmable	Dimension
UP-DL110-6-25W	AC230V	25W	≥0.9	2300	90°	3000K	40000h	≥80	No	Ø195*46.5mm cutout 175-185mm
UP-DL110-6-25W	AC230V	25W	≥0.9	2450	90°	4000K	40000h	≥80	No	Ø195*46.5mm cutout 175-185mm
UP-DL110-6-25W	AC230V	25W	≥0.9	2500	90°	5000K	40000h	≥80	No	Ø195*46.5mm cutout 175-185mm
UP-DL110-6-25W	AC230V	25W	≥0.9	2550	90°	5700K	40000h	≥80	No	Ø195*46.5mm cutout 175-185mm
UP-DL110-6-25W-D	AC230V	25W	≥0.9	2170	90°	3000K	40000h	≥80	Yes	Ø195*46.5mm cutout 175-185mm
UP-DL110-6-25W-D	AC230V	25W	≥0.9	2370	90°	4000K	40000h	≥80	Yes	Ø195*46.5mm cutout 175-185mm
UP-DL110-6-25W-D	AC230V	25W	≥0.9	2400	90°	5000K	40000h	≥80	Yes	Ø195*46.5mm cutout 175-185mm
UP-DL110-6-25W-D	AC230V	25W	≥0.9	2450	90°	5700K	40000h	≥80	Yes	Ø195*46.5mm cutout 175-185mm

Driver data Sheet

Driver data	DIM	Non dim
Input rated Voltage	AC230V	AC230V
Frequency	50Hz	50/60Hz
Input Voltage	AC200-240V	AC200-240V
Efficiency	≥85%	≥86%
Total load Wattage	25W±5%	25W±5%
Power Factor	≥0.9	≥0.9
Rated input current	≤0.14A	≤0.14A
Full load output Voltage	DC23-40V	DC24-40V
Rated output current	700mA	700mA
Output current range	700mA±5%	700mA±5%
Power tolerance	±5%	±5%
Current output tolerance	±5%	±5%
Dimming range	8%-100%	—
Dimmer	Triac dimmers	—
Short circuit protection	PASS	PASS
Over voltage protection	PASS	PASS
Over temperature protection	PASS	PASS
THD	≤18%	≤18%
Withstand voltage	AC3750V	AC3750V

Fixture Compatibility

Rated Wattage	Electrical Classification	Ingress Protection	Operating Temp	Operating Humidity	Storage Temp
25W	II	IP65	-20°C~45°C	0~90%	-20°C~65°C

Spectral Distribution

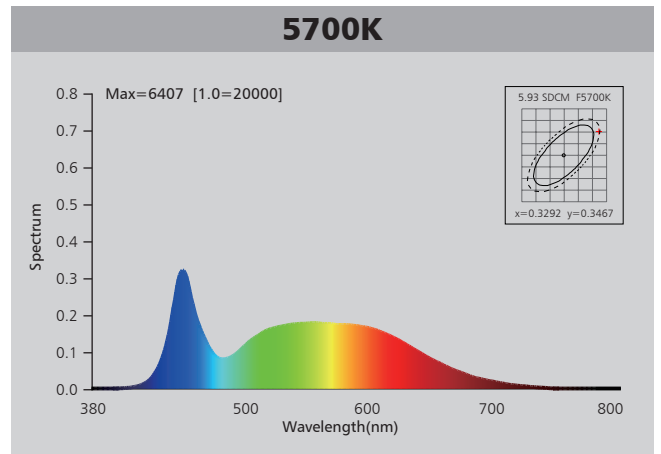
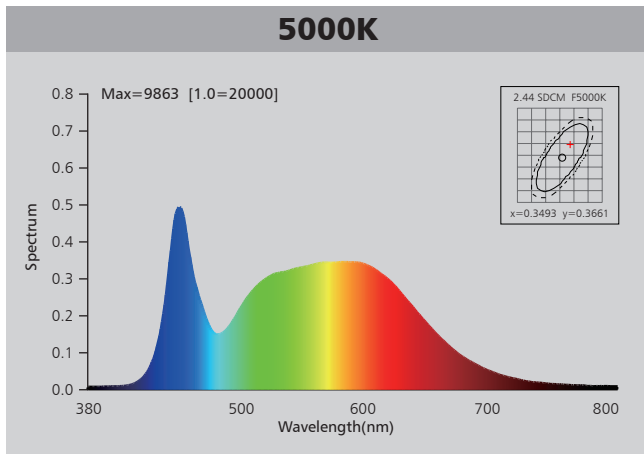
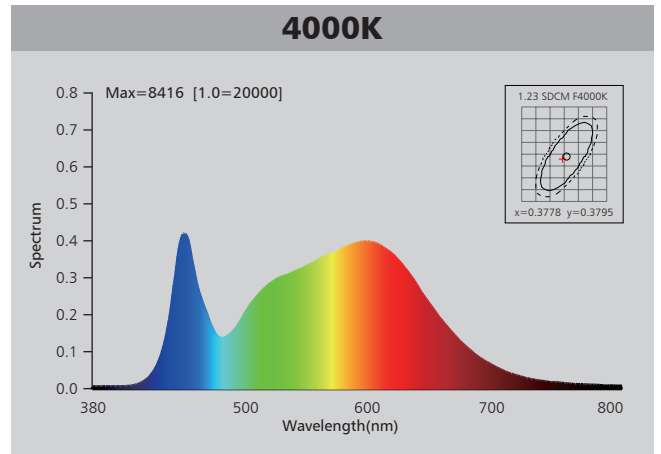
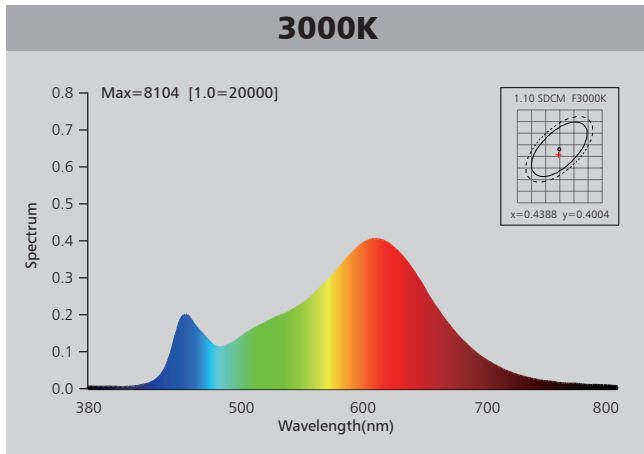

Photometric Diagram

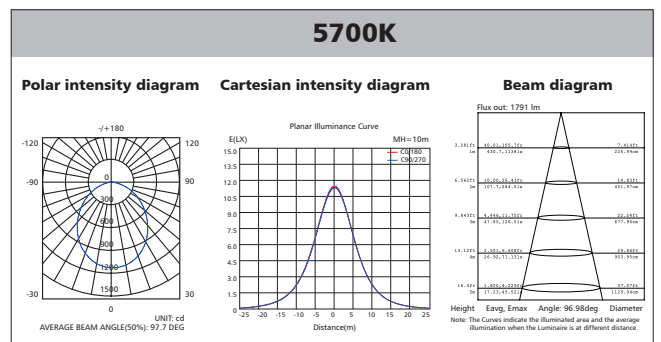
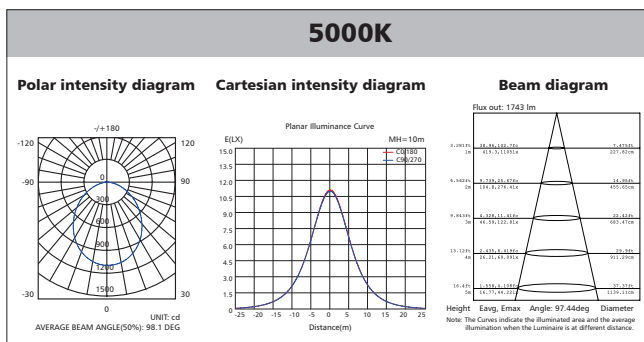
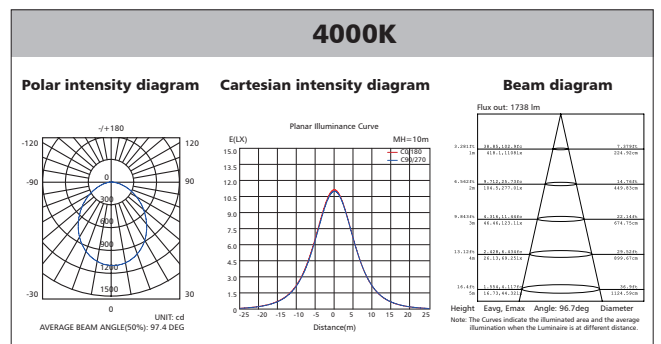
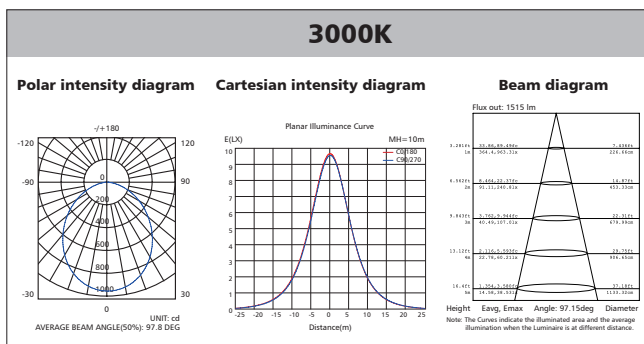

Polar Diagram Comparison

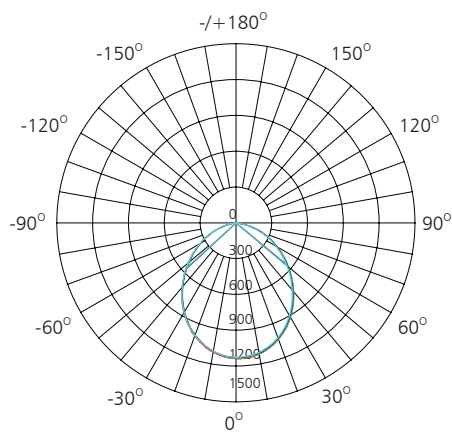

UNIT: cd

- C0/180, 97.7 deg
- C30/210, 97.7 deg
- C60/240, 97.6 deg
- C90/270, 97.6 deg

AVERAGE BEAM ANGLE (50%): 97.7DEG



Driver lifetime & LED light decay rate

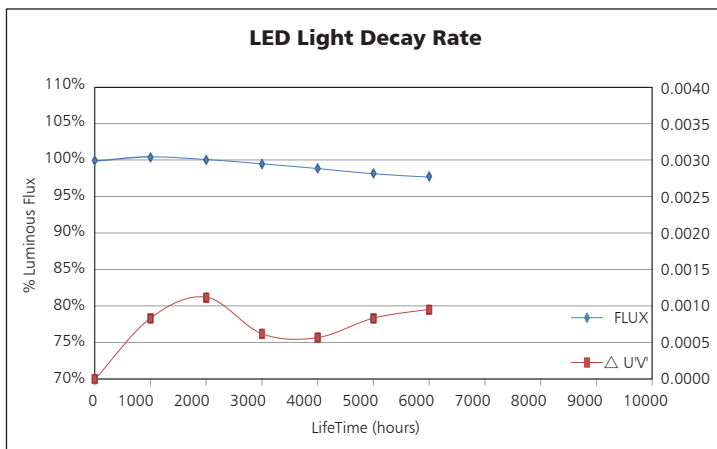
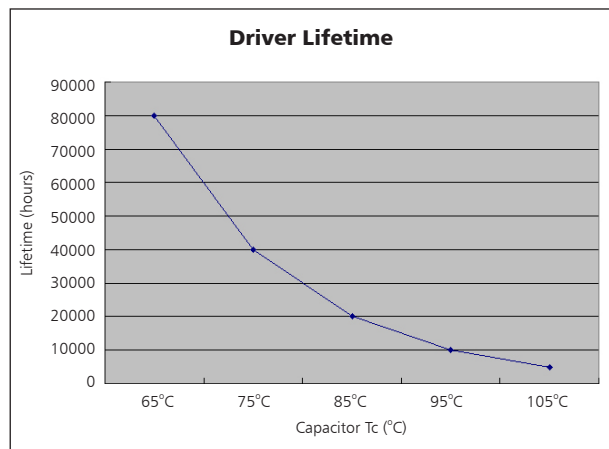

Temperature

- The testing is operated at 25°C
- The lifetime of capacitor, minimum of 5,000 hours if operated at 105°C, will be doubled whenever the temperature drops 10°C
- The highest withstand temperature of IC, MOS could be 120°C
- The highest withstand temperature of LED junction temperature is 150°C

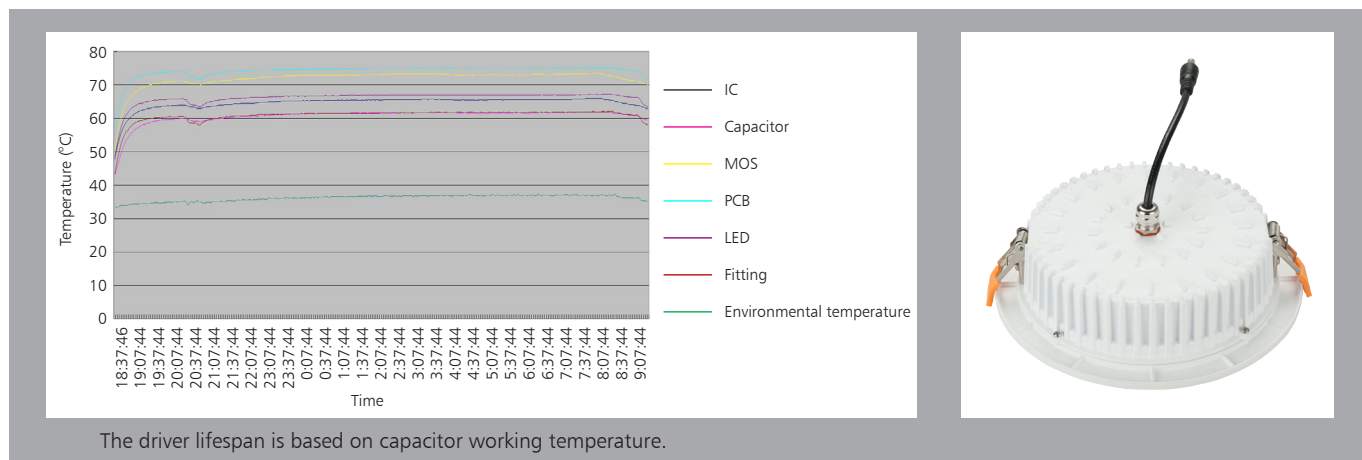

The driver lifespan is based on capacitor working temperature.

Installation

Install requirements	
A-gap above the fitting	25mm
B-gap to the building material	25mm
C-gap to the thermal insulation	50mm

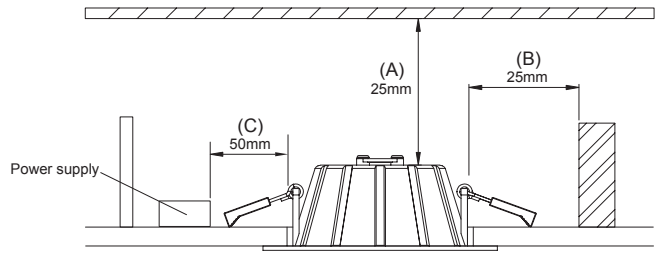

1. Open a hole according to the cutout size of led downlight.

2. Use screw-driver to open the driver terminal cover, feed the main AC wire L. N. in terminal block respectively, then fix the cover back.

3. Connect the downlight with driver, hold back the spring clip then push the downlight into the hole.

4. Make sure the downlight fixed tightly in ceiling, turn on the power (Fig 1).

Packaging Information

	SIZE(CM)	N.W/pc (KGS)	G.W.(KGS)	Q'TY(PCS)
Carton	42*42*39.5	0.75	12.5	12

	CTNS	Q'TY(PCS)	VOLUME(CBM)
20" standard container	396	4752	28
40" standard container	792	9504	56

