



UPSHINE[®]



Technical Application Guide for UP-SHINE LED Downlight

UP-DL103B-2.5-10W

Introduction



DL103 LED recessed downlight adopts super slim and compact design, perfectly suitable for the narrow ceiling installation. IP65 rating front cover design, suitable for damp environment. Traditional diamond plaited surface lens design ensures the high light transmittance and uniform lighting output. T-shape heat sink greatly increases the radiation area and improves cooling efficiency.

- Up to 70% energy saving compared to standard CFL
- Long lifetime of 40,000 hours
- Triac dim, 0-10V dim, DALI dim
- 36°/60° wide beam angle
- Ø75-80mm cutout
- CCT: 2700K 3000K
4000K 5000K
- No UV/IR light
- Environment friendly, without Mercury or any other hazardous substances

Application notes

- Professional electrician for installation only
- Switch off before installation
- Do not touch when in use
- Keep away from hot steam and corrosive gas

Application Areas

It is designed for general lighting applications in office, supermarket, shop, school, hotel, etc. It is also widely used for public areas, such as stairway, lobby, reception, corridors etc.

Certificate

CE RoHS SAA



Product Information

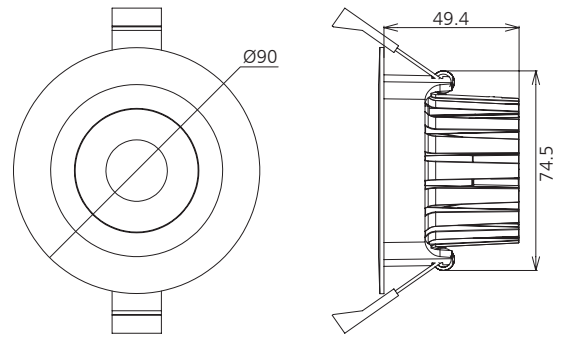

Technical Specifications

Model	Voltage	Power	Power Factor	Lumen (±5%)	Beam angle	CCT	Lifespan	CRI	Dimmable	Dimension
UP-DL103B-2.5-10W	AC230V	10W	≥0.9	860	36°/60°	2700K	40000h	≥80	No	Ø90*49.4mm cutout Ø75-80mm
UP-DL103B-2.5-10W	AC230V	10W	≥0.9	870	36°/60°	3000K	40000h	≥80	No	Ø90*49.4mm cutout Ø75-80mm
UP-DL103B-2.5-10W	AC230V	10W	≥0.9	1000	36°/60°	4000K	40000h	≥80	No	Ø90*49.4mm cutout Ø75-80mm
UP-DL103B-2.5-10W	AC230V	10W	≥0.9	970	36°/60°	5000K	40000h	≥80	No	Ø90*49.4mm cutout Ø75-80mm
UP-DL103B-2.5-10W-D	AC230V	10W	≥0.9	840	36°/60°	2700K	40000h	≥80	Yes	Ø90*49.4mm cutout Ø75-80mm
UP-DL103B-2.5-10W-D	AC230V	10W	≥0.9	870	36°/60°	3000K	40000h	≥80	Yes	Ø90*49.4mm cutout Ø75-80mm
UP-DL103B-2.5-10W-D	AC230V	10W	≥0.9	980	36°/60°	4000K	40000h	≥80	Yes	Ø90*49.4mm cutout Ø75-80mm
UP-DL103B-2.5-10W-D	AC230V	10W	≥0.9	930	36°/60°	5000K	40000h	≥80	Yes	Ø90*49.4mm cutout Ø75-80mm
UP-DL103B-2.5-10W	AC230V	10W	≥0.9	640	36°/60°	2700K	40000h	≥90	No	Ø90*49.4mm cutout Ø75-80mm
UP-DL103B-2.5-10W	AC230V	10W	≥0.9	670	36°/60°	3000K	40000h	≥90	No	Ø90*49.4mm cutout Ø75-80mm
UP-DL103B-2.5-10W	AC230V	10W	≥0.9	760	36°/60°	4000K	40000h	≥90	No	Ø90*49.4mm cutout Ø75-80mm
UP-DL103B-2.5-10W	AC230V	10W	≥0.9	720	36°/60°	5000K	40000h	≥90	No	Ø90*49.4mm cutout Ø75-80mm
UP-DL103B-2.5-10W-D	AC230V	10W	≥0.9	630	36°/60°	2700K	40000h	≥90	Yes	Ø90*49.4mm cutout Ø75-80mm
UP-DL103B-2.5-10W-D	AC230V	10W	≥0.9	660	36°/60°	3000K	40000h	≥90	Yes	Ø90*49.4mm cutout Ø75-80mm
UP-DL103B-2.5-10W-D	AC230V	10W	≥0.9	750	36°/60°	4000K	40000h	≥90	Yes	Ø90*49.4mm cutout Ø75-80mm
UP-DL103B-2.5-10W-D	AC230V	10W	≥0.9	710	36°/60°	5000K	40000h	≥90	Yes	Ø90*49.4mm cutout Ø75-80mm

Driver data Sheet

Driver data	DIM	Non dim
Input rated Voltage	AC230V	AC230V
Frequency	50Hz	50/60Hz
Input Voltage	AC200-240V	AC200-240V
Efficiency	≥82%	≥82%
Total load Wattage	10W±1W	10W±1W
Power Factor	≥0.9	≥0.9
Rated input current	≤0.06A	≤0.06A
Full load output Voltage	DC23-40V	DC25-42V
Rated output current	230mA	230mA
Output current range	230mA±5%	230mA±5%
Power tolerance	±5%	±5%
Current output tolerance	±5%	±5%
Dimming range	8%-100%	—
Dimmer	Triac dimmers	—
Short circuit protection	PASS	PASS
Over voltage protection	PASS	PASS
Over temperature protection	PASS	PASS
THD	≤18%	≤18%
Withstand voltage	AC3750V	AC3750V

Fixture Compatibility

Rated Wattage	Electrical Classification	Ingress Protection	Operating Temp	Operating Humidity	Storage Temp
10W	II	IP65	-20°C~45°C	0~90%	-20°C~65°C

Spectral Distribution

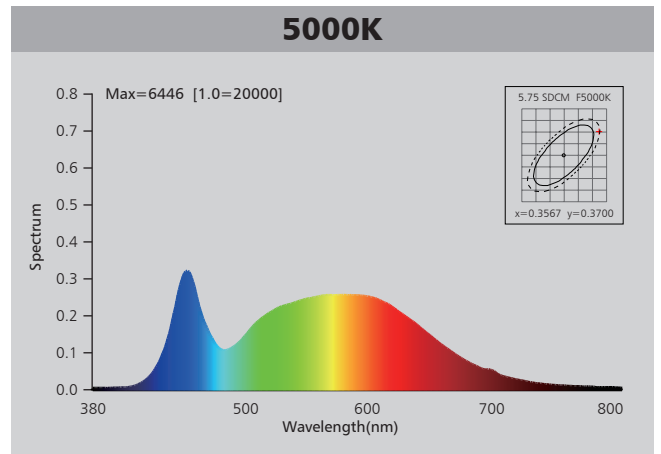
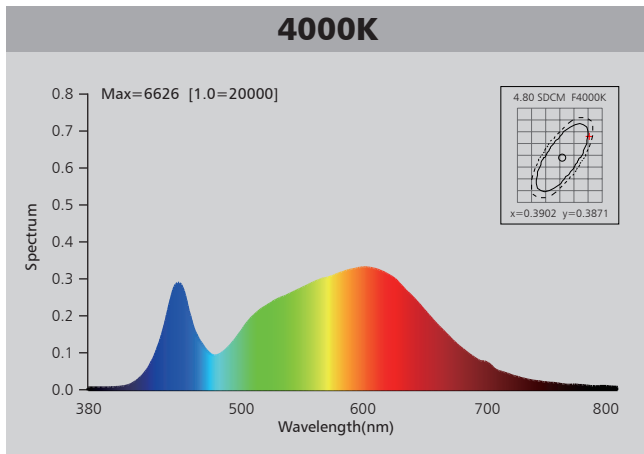
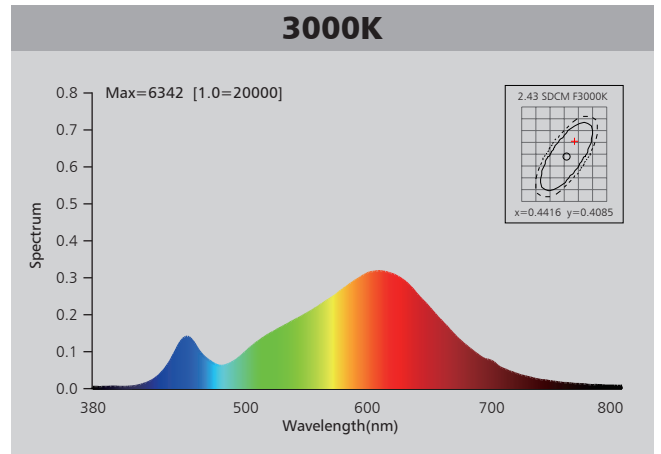
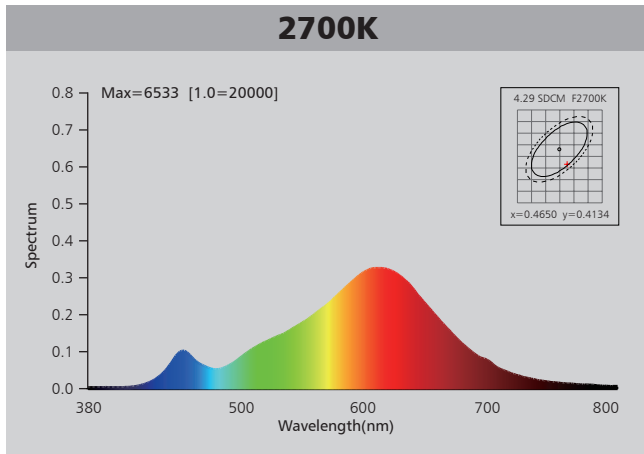

Photometric Diagram

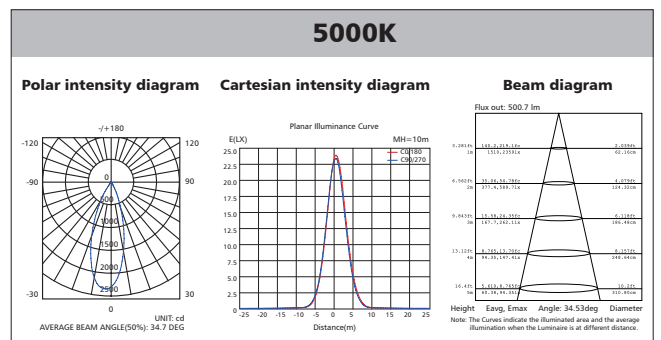
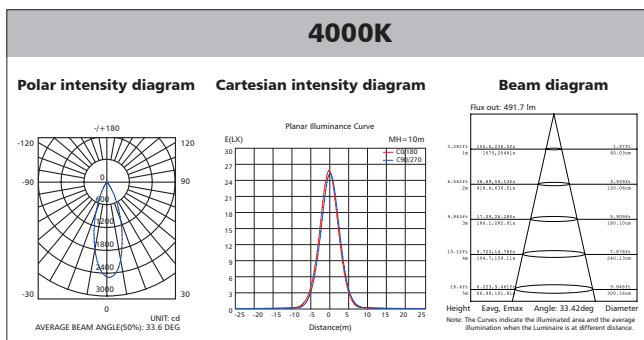
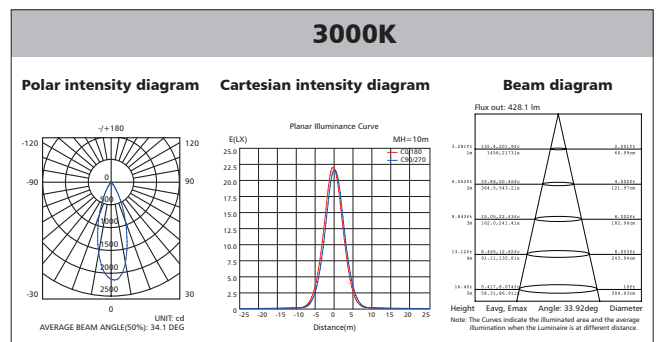
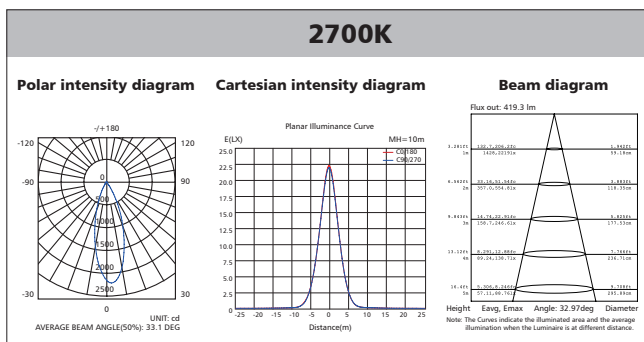

Polar Diagram Comparison

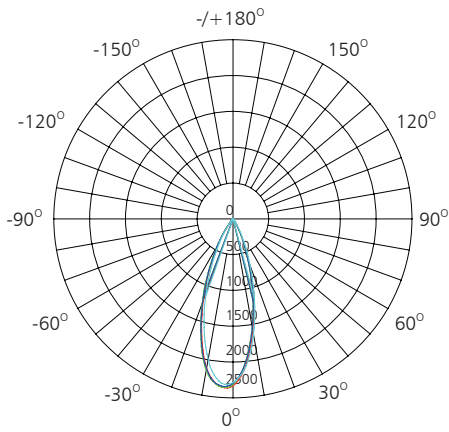

UNIT: cd

- C0/180, 34.7 deg
- C30/210, 34.8 deg
- C60/240, 34.8 deg
- C90/270, 34.6 deg

AVERAGE BEAM ANGLE (50%): 34.7DEG



Driver lifetime & LED light decay rate

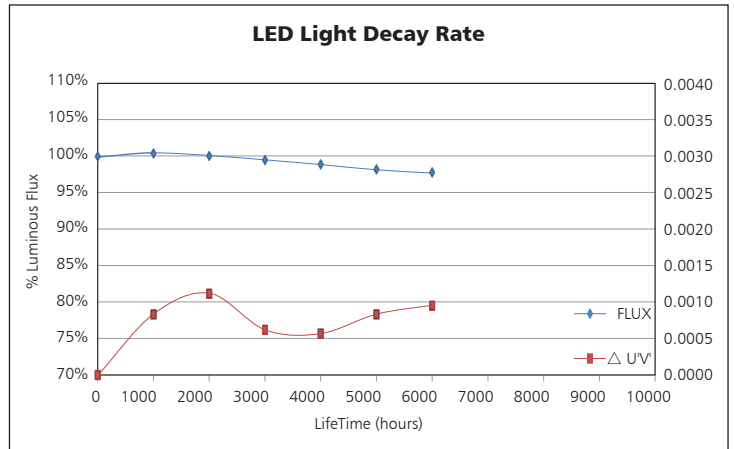
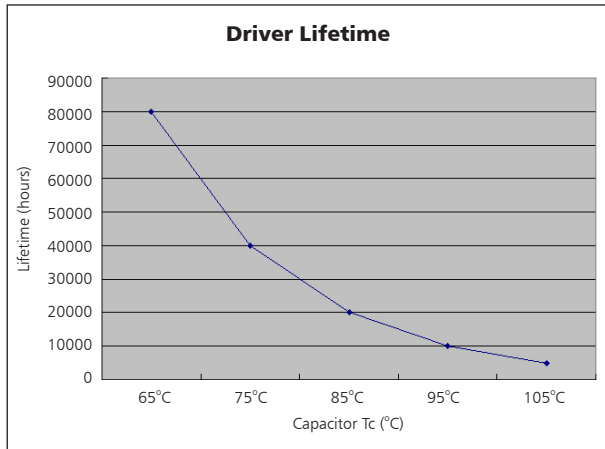

Temperature

- The testing is operated at 25°C
- The lifetime of capacitor, minimum of 5,000 hours if operated at 105°C, will be doubled whenever the temperature drops 10°C
- The highest withstand temperature of IC, MOS could be 120°C
- The highest withstand temperature of LED junction temperature is 150°C

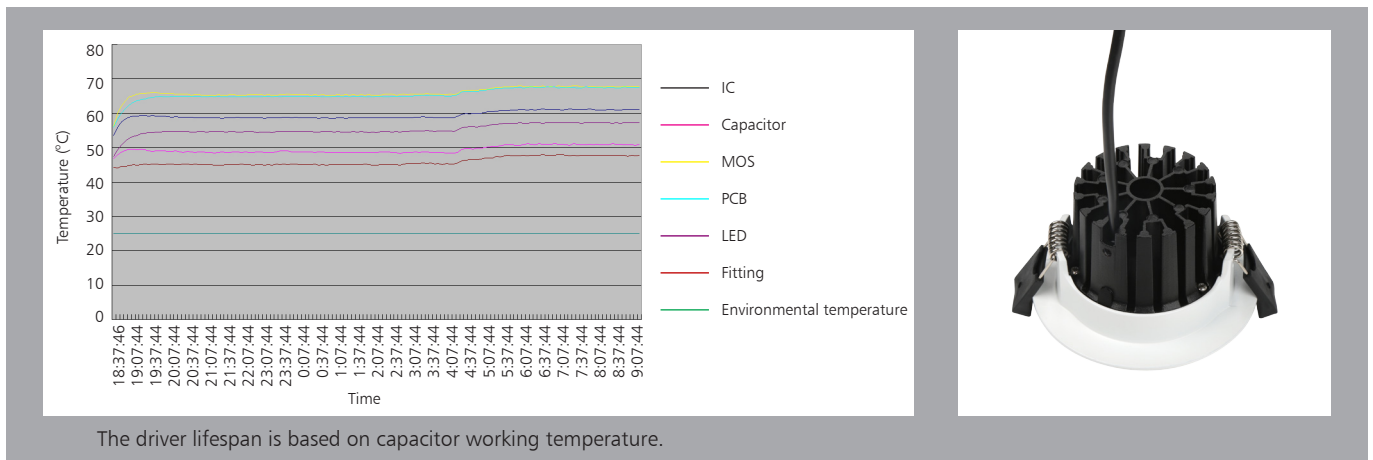

Installation

Install requirements	
A-gap above the fitting	25mm
B-gap to the building material	25mm
C-gap to the thermal insulation	50mm

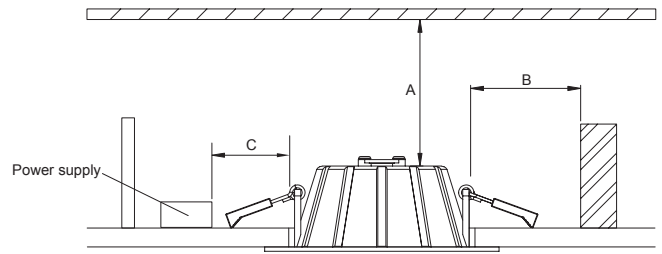

1. Open a hole according to the cutout size of led downlight.

2. Use screw-driver to open the driver terminal cover, feed the main AC wire L. N. in terminal block respectively, then fix the cover back.

3. Connect the downlight with driver, hold back the spring clip then push the downlight into the hole.

4. Make sure the downlight fixed tightly in ceiling, turn on the power (Fig 1).

Packaging Information

	SIZE(CM)	N.W/pc (KGS)	G.W.(KGS)	Q'TY(PCS)
Carton	57.5*57.5*20	0.265	16.95	50

	CTNS	Q'TY(PCS)	VOLUME(CBM)
20" standard container	416	20800	28
40" standard container	832	41600	56

