



UPSHINE<sup>®</sup>



Technical Application  
Guide for UP-SHINE  
LED Downlight

UP-CL79-2.5-10W

# Introduction

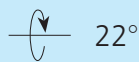

CL79 downlight achieves 100 LPW high efficiency by adopting super high lumen COB and excellent light transmittance prismatic lens. Smart cooling system is specially designed in metal device with vertical fins, allow air flow upward and downward smoothly. It has adjustable head for different lighting directions. External power supply, easy maintenance.

- Up to 70% energy saving compared to standard CFL
- Long lifetime of 40,000 hours
- Dimmable when using triac dimmer
- 36°/60° wide beam angle
- Ø84mm cutout
- CCT: 2700K 3000K  
4000K 5000K
- No UV/IR light
- Environment friendly, without Mercury or any other hazardous substances

## Application notes

- IP40 for indoor use only
- Professional electrician for installation only
- Switch off before installation
- Do not touch when in use
- Keep away from hot steam and corrosive gas

## Application Areas

It is designed for general lighting applications in office, supermarket, shop, school, hotel, etc. It is also widely used for public areas, such as stairway, lobby, reception, corridors etc.

## Certificate

CE RoHS SAA



# Product Information

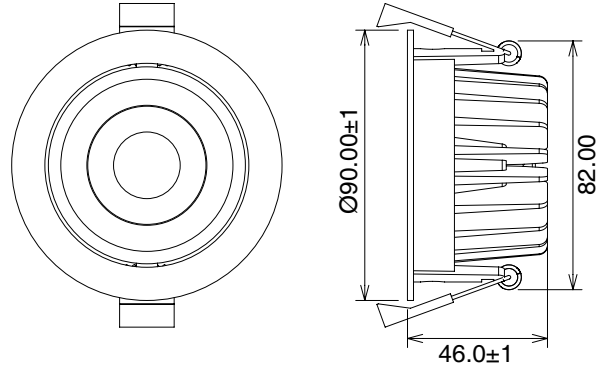

## Technical Specifications

Model	Voltage	Power	Power Factor	Lumen (±5%)	Beam angle	CCT	Lifespan	CRI	Dimmable	Dimension
UP-CL79-2.5-10W	AC230V	10W	≥0.85	870	36°/60°	2700K	40000h	≥80	No	Ø90*46mm cutout 84mm
UP-CL79-2.5-10W	AC230V	10W	≥0.85	890	36°/60°	3000K	40000h	≥80	No	Ø90*46mm cutout 84mm
UP-CL79-2.5-10W	AC230V	10W	≥0.85	980	36°/60°	4000K	40000h	≥80	No	Ø90*46mm cutout 84mm
UP-CL79-2.5-10W	AC230V	10W	≥0.85	1010	36°/60°	5000K	40000h	≥80	No	Ø90*46mm cutout 84mm
UP-CL79-2.5-10W-D	AC230V	10W	≥0.9	850	36°/60°	2700K	40000h	≥80	Yes	Ø90*46mm cutout 84mm
UP-CL79-2.5-10W-D	AC230V	10W	≥0.9	860	36°/60°	3000K	40000h	≥80	Yes	Ø90*46mm cutout 84mm
UP-CL79-2.5-10W-D	AC230V	10W	≥0.9	960	36°/60°	4000K	40000h	≥80	Yes	Ø90*46mm cutout 84mm
UP-CL79-2.5-10W-D	AC230V	10W	≥0.9	970	36°/60°	5000K	40000h	≥80	Yes	Ø90*46mm cutout 84mm

## Driver data Sheet

Driver data	DIM	Non-dim
Input rated Voltage	AC230V	AC230V
Frequency	50HZ	50HZ
Input Voltage	AC200-240V	AC200-240V
Efficiency	≥75%	≥81%
Total load Wattage	10W±1W	10W±1W
Power Factor	≥0.9	≥0.85
Rated input current	≤0.06A	≤0.06A
Full load output Voltage	DC33-38V	DC33-38V
Rated output current	220mA	230mA
Output current range	220mA±5%	230mA±5%
Power tolerance	±5%	±5%
Current output tolerance	±5%	±5%
Dimming range	8%-100%	—
Dimmer	Triac dimmers	—
Short circuit protection	PASS	PASS
Over voltage protection	PASS	PASS
Over temperature protection	PASS	PASS
THD	25%	20%
Withstand voltage	AC3750V	AC3750V

## Fixture Compatibility

Rated Wattage	Electrical Classification	Ingress Protection	Operating Temp	Operating Humidity	Storage Temp
10W	II	IP40	-20°C~45°C	0~90%	-20°C~65°C

# Spectral Distribution

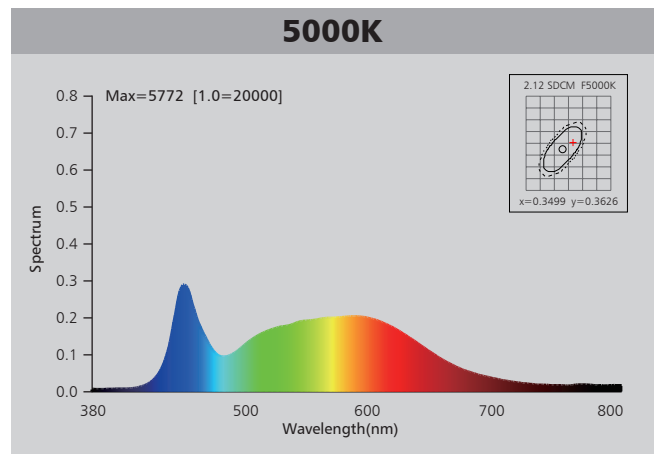
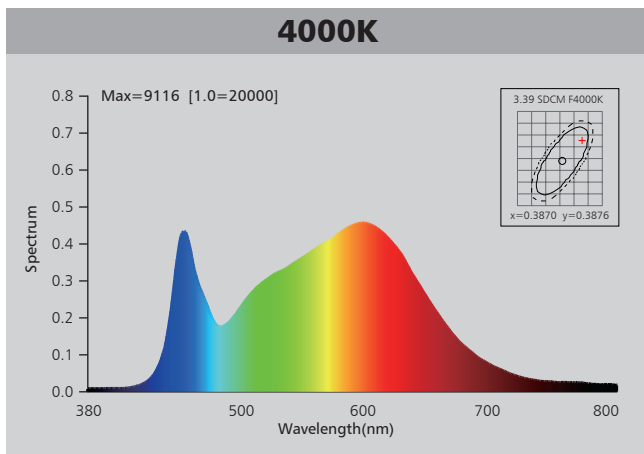
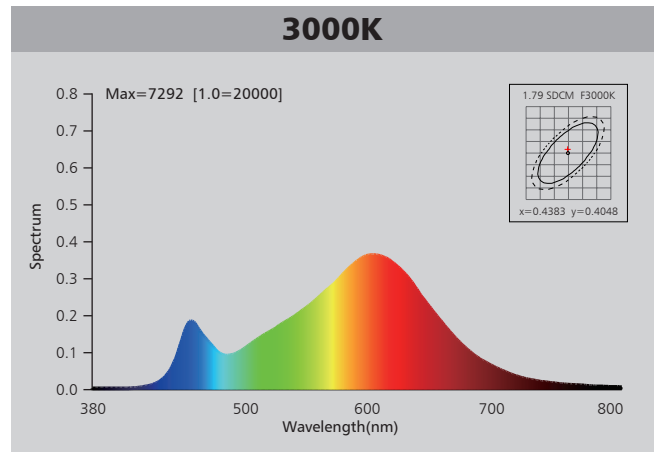
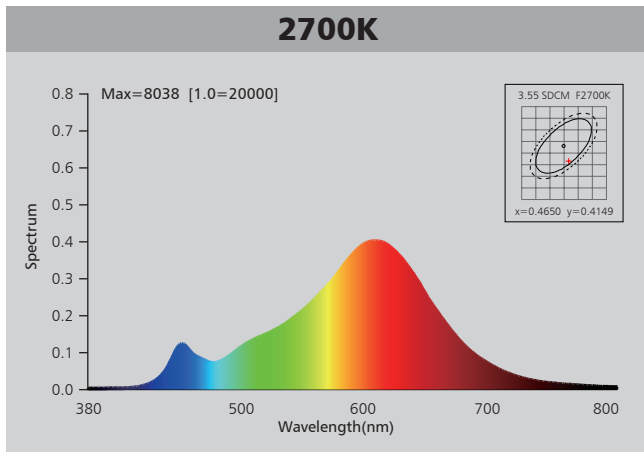

# Photometric Diagram

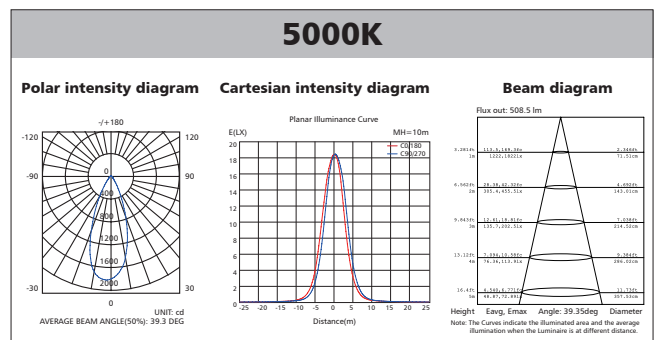
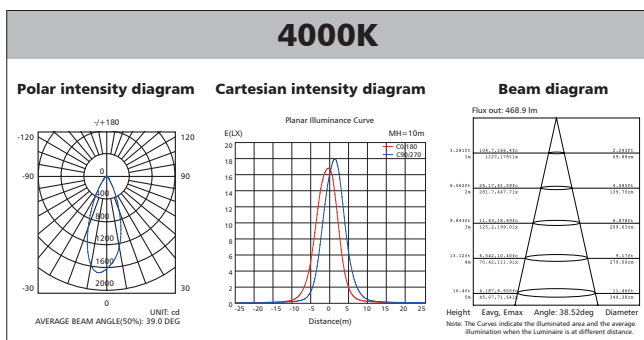
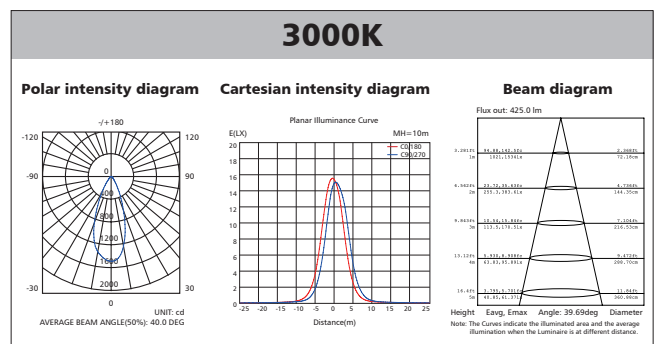
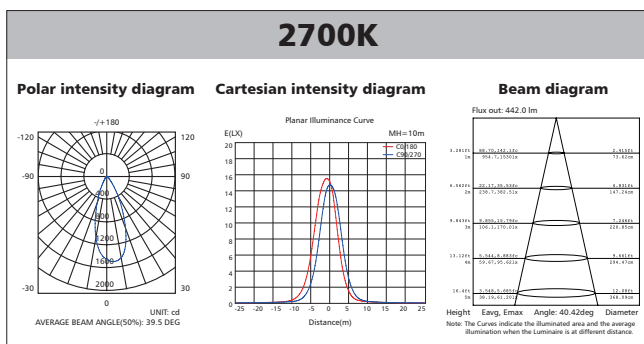

# Polar Diagram Comparison

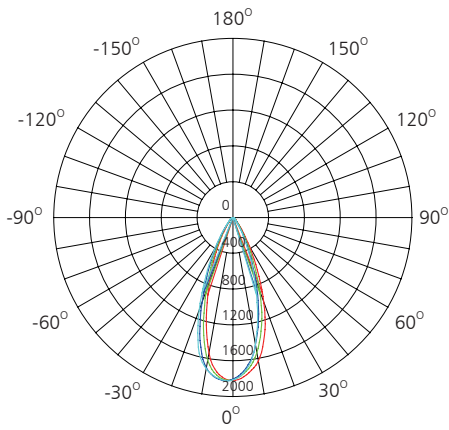

UNIT: cd

- C0/180, 39.6 deg
- C30/210, 39.3 deg
- C60/240, 39.1 deg
- C90/270, 39.3 deg

AVERAGE BEAM ANGLE (50%): 39.3DEG



# Driver lifetime & LED light decay rate

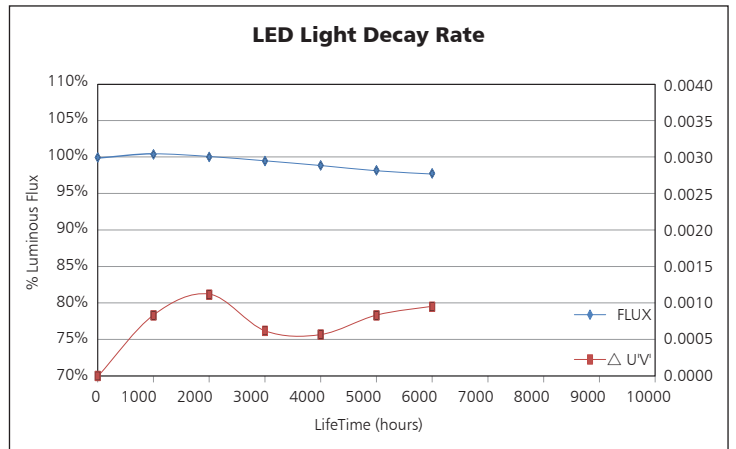
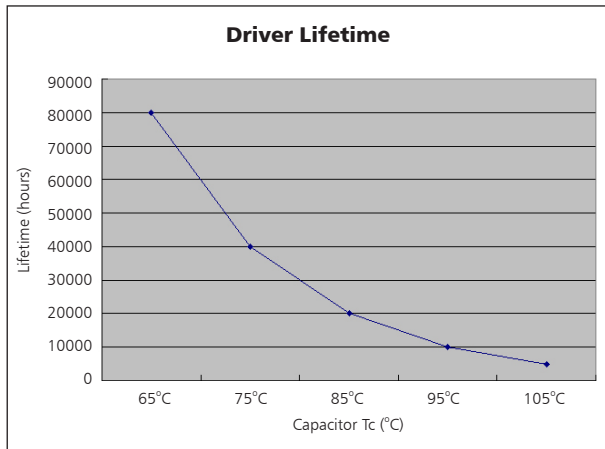

# Temperature

- The testing is operated at 25°C
- The lifetime of capacitor, minimum of 5,000 hours if operated at 105°C, will be doubled whenever the temperature drops 10°C
- The highest withstand temperature of IC, MOS could be 120°C
- The highest withstand temperature of LED junction temperature is 150°C

The driver lifespan is based on capacitor working temperature.

# Installation

Install requirements	
A-gap above the fitting	25mm
B-gap to the building material	25mm
C-gap to the thermal insulation	25mm

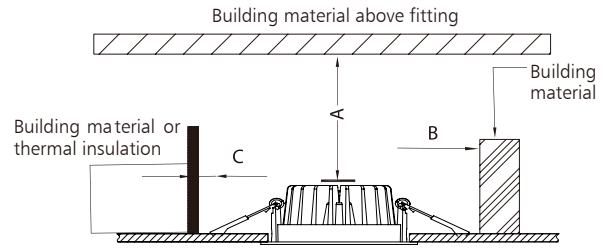

<p><b>Ceiling Opening</b></p> <p style="text-align: right;">1</p>	<p><b>Connect Power supply</b></p> <p><b>Spring Clips</b></p> <p style="text-align: right;">2</p>
<p><b>A. Hold back spring clips</b></p> <p><b>B. Push downlight into position</b></p> <p style="text-align: right;">3</p>	<p><b>Spring Clips</b></p> <p><b>Ceiling</b></p> <p style="text-align: right;">4</p>

# Packaging Information

	SIZE(CM)	N.W/pc (KGS)	G.W.(KGS)	Q'TY(PCS)
Carton	46*46*29.5	0.26	13	48

	CTNS	Q'TY(PCS)	VOLUME(CBM)
20" standard container	440	21120	28
40" standard container	880	42240	56

