



UPSHINE[®]



Technical Application
Guide for UP-SHINE
LED Ceiling light
UP-AL12-10-12W-M

Introduction

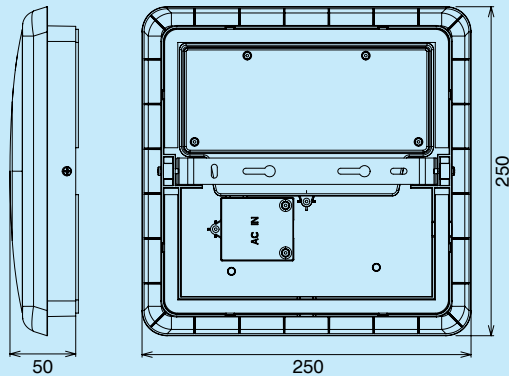

Detection Pattern

Ceiling Mounting pattern (Unit: m)

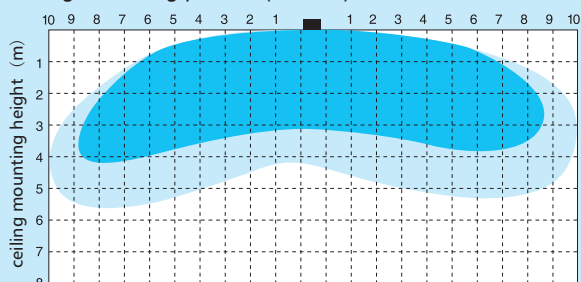

Wall Mounting pattern (Unit: m)

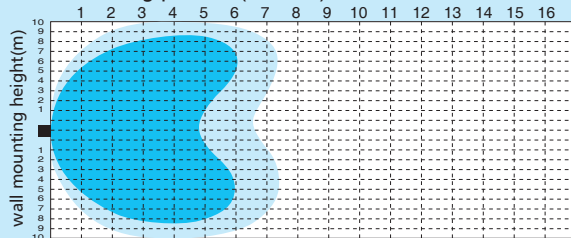

■ High detection area ■ Low detection area

Up-shine surface mounted ceiling light adopts high lumen SMD LED, fire-rated PC diffuser with even light output. IP54 waterproof structural design, it is an ideal replacement for damp locations. driver in top branded component with triac dimmable function, 120° wide beam angle.

- Up to 70% energy saving compared to standard CFL
- Long lifetime of 40,000 hours
- 120° wide beam angle
- CCT: 3000K 4000K 5000K 5700K
- No UV/IR light
- Environment friendly, without Mercury or any other hazardous substances

Daylight & Microwave Sensor

Detection area:

- ◆ 140 degree wide detective beam angle with 5~7 meters distance.

Working pattern:

- ◆ With sufficient natural light, when illuminance is more than 10lux, the light does not switch on when presence detected.
- ◆ With insufficient natural light:
 - When illuminance is less than 10lux, the light switches on automatically when presence detected.
 - With presence detected, light will never switch off, even the nature light is sufficient.
 - After presence left, any movement detected within time-delay (30 seconds), the light will continuously work for another hold time(30 seconds), then switch off automatically until next movement detected.
 - Hold time: 30S

Microwave Sensor

Detection area:

- ◆ 140 degree wide detective beam angle with 5~7 meters distance.

Working pattern:

- ◆ In any given lighting condition, the light switches on automatically when presence detected.
- ◆ After presence left, light will continuously work within time-delay (30 seconds),then switch off automatically.
- ◆ After presence left, any movement detected within time-delay (30 seconds), the light will continuously work for another hold time (30 seconds), then switch off until next movement detected.
- ◆ Hold time: 30S

Emergency

Smart IC control.

- ◆ Emergency function switches automatically between power cut and power restoration.
- ◆ Li battery, high efficiency
- ◆ Battery duration: 3 hours@4W
- ◆ Charge period: 24 hours

Application Areas

Applicable for corridor, basement, garage, warehouse, monitoring, and other places of energy-saving indoor and outdoor lighting.

Certificate

CE RoHS



Technical Specifications

Model	Voltage	Power	Power Factor	Lumen (±5%)	Beam angle	CCT	Lifespan	CRI	Dimmable	Dimension
UP-AL12-10-12W-M	AC230V	12W	≥0.9	1200	120°	3000K	40000h	≥80	No	250*250*50mm
UP-AL12-10-12W-M	AC230V	12W	≥0.9	1320	120°	4000K	40000h	≥80	No	250*250*50mm
UP-AL12-10-12W-M	AC230V	12W	≥0.9	1330	120°	5000K	40000h	≥80	No	250*250*50mm
UP-AL12-10-12W-M	AC230V	12W	≥0.9	1330	120°	5700K	40000h	≥80	No	250*250*50mm

Driver data Sheet

Driver data	Sensor	Emergency	Main Power
Input rated Voltage	AC230V	AC230V	AC230V
Frequency	50Hz	50Hz	50Hz
Input Voltage	AC200-240V	AC200-240V	AC200-240V
Efficiency	—	≥70%	≥88%
No load wattage	—	—	≤0.4W
Total load Wattage	2W±0.5W	4W±0.5W	12W±1W
Power Factor	—	—	≥0.9
Rated input current	≤0.02A	≤0.04A	≤0.07A
Full load output Voltage	—	DC24-38V	60-75V
Rated output current	—	100-170mA	150mA
Output current range	—	—	150mA±5%
Power tolerance	—	—	±5%
Current output tolerance	—	—	±5%
Hold time	30S	—	—
Detection distance	5-7m	—	—
Battery duration	—	3h@4W	—
Charge Period	—	24h	—
Short circuit protection	—	—	PASS
Over voltage protection	—	—	PASS
Over temperature protection	—	—	PASS
Withstand voltage	—	—	AC3750V

Fixture Compatibility

Rated Wattage	Electrical Classification	Ingress Protection	Operating Temp	Operating Humidity	Storage Temp
12W	II	IP54	-20°C~45°C	0~90%	-20°C~65°C

Wiring Diagram:

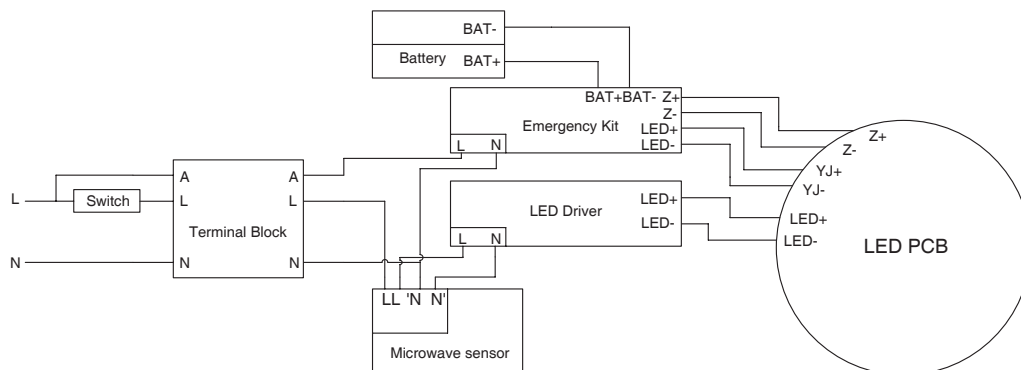

Spectral Distribution

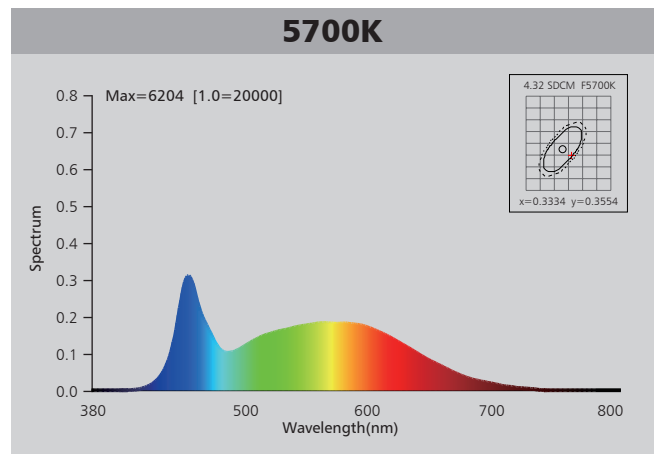
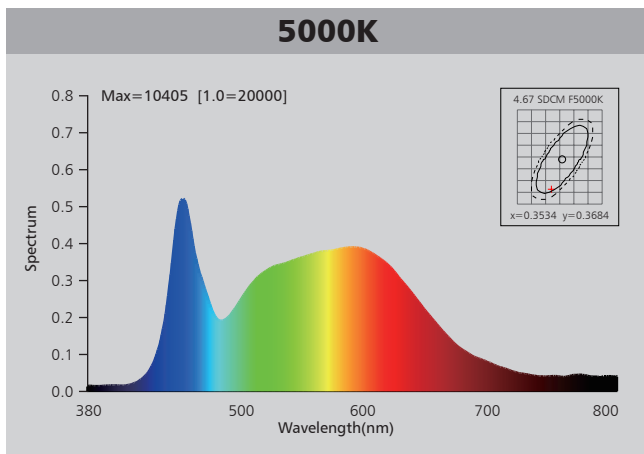
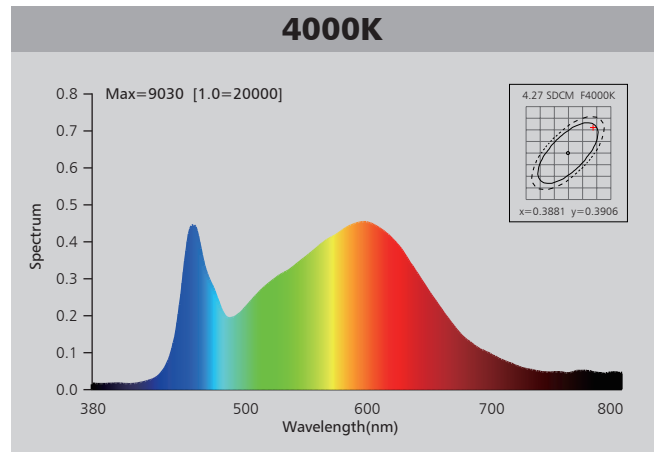
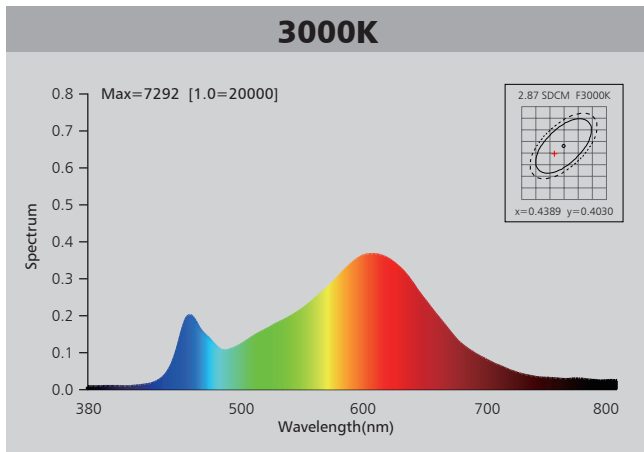

Photometric Diagram

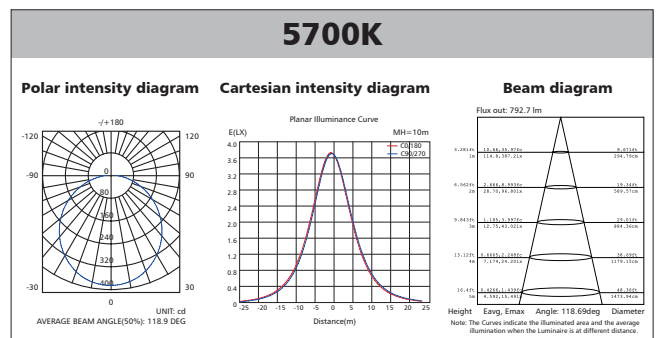
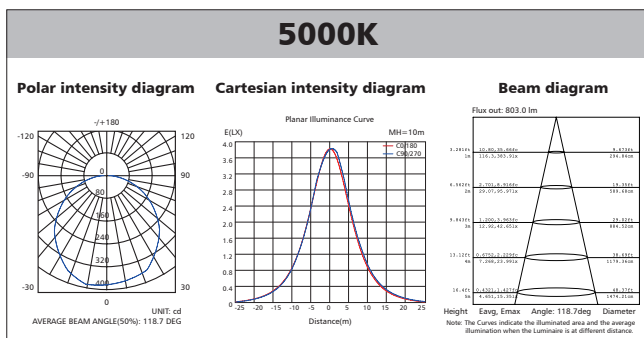
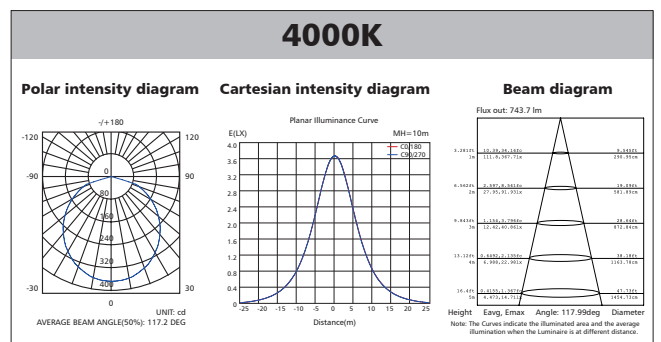
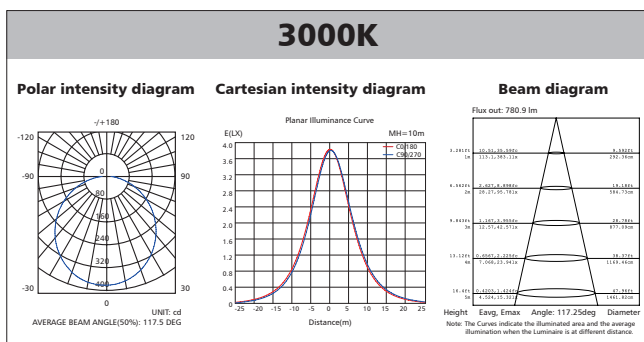

Polar Diagram Comparison

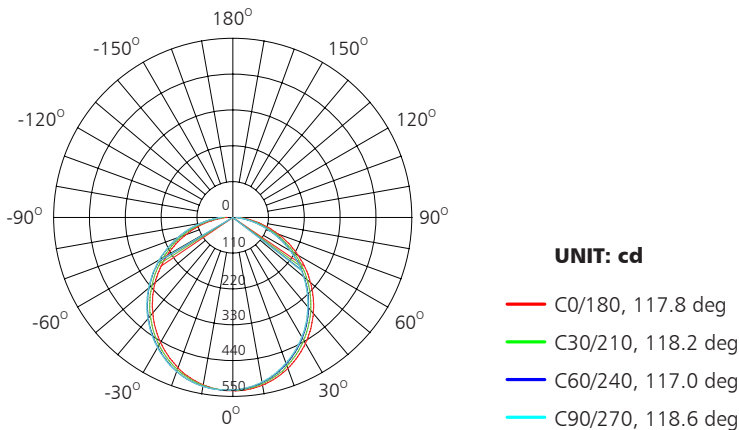

AVERAGE BEAM ANGLE (50%): 118.9DEG

Driver lifetime & LED light decay rate

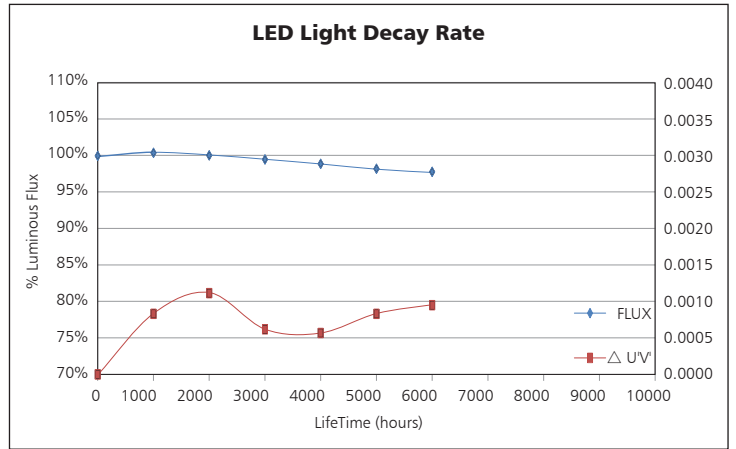
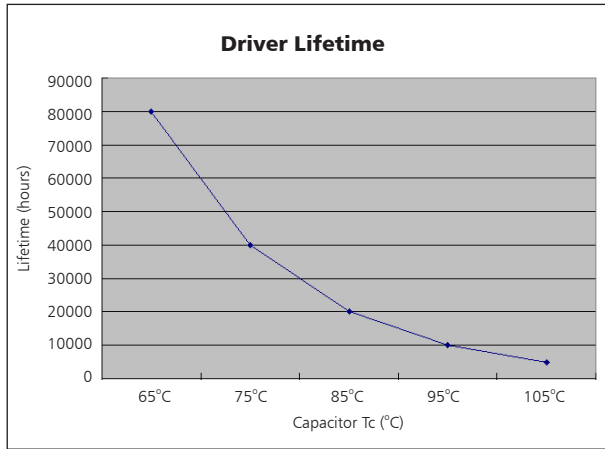

Temperature

- The testing is operated at 25°C
- The lifetime of capacitor, minimum of 5,000 hours if operated at 105°C, will be doubled whenever the temperature drops 10°C
- The highest withstand temperature of IC, MOS could be 120°C
- The highest withstand temperature of LED junction temperature is 150°C

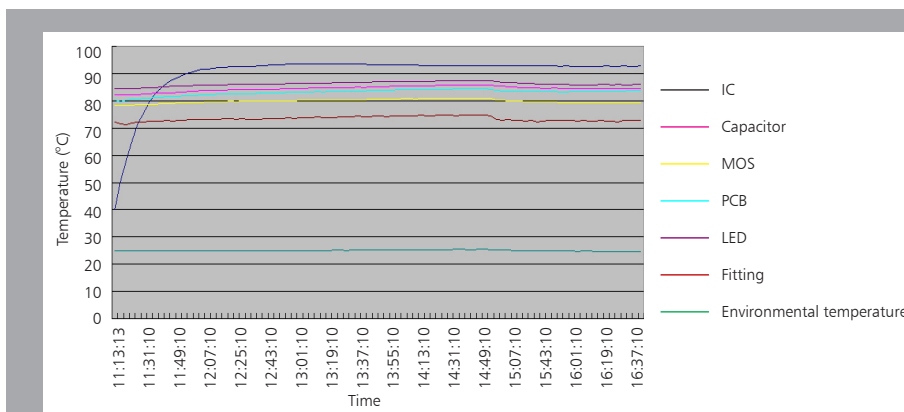

The driver lifespan is based on capacitor working temperature.

Installation

1. Take out ceiling light and accessory pack from box

2. Knock-in the plastic anchor into ceiling

3. Remove screw, take out bracket

4. Fix bracket with screw into the ceiling

5. Open junction box, wire "L" "N" "A" to terminal block and mount ceiling light into the right place

— A = UNSWITCHED
— L = SWITCHED
— N = NEUTRAL

6. Switch on

Packaging Information

	SIZE(CM)	N.W/pc (KGS)	G.W.(KGS)	Q'TY(PCS)
Carton	60*53.5*28.5	0.87	21.2	20

	CTNS	Q'TY(PCS)	VOLUME(CBM)
20" standard container	302	6040	28
40" standard container	604	12080	56

