



UPSHINE®



Technical Application  
Guide for UP-SHINE  
LED Ceiling light  
UP-AL08-12-30W

# Introduction

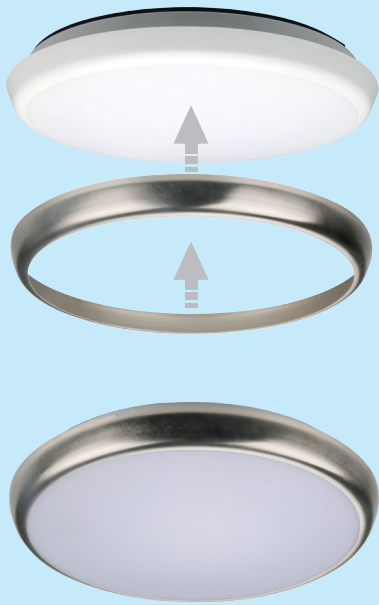

Up-shine surface mounted ceiling light adopts high lumen SMD LED, fire-rated PC diffuser with even light output. IP54 waterproof structural design, it is an ideal replacement for damp locations. Isolated driver in top branded component with triac dimmable function, 120° wide beam angle.

- Up to 70% energy saving compared to standard CFL
- Long lifetime of 40,000 hours
- Dimmable when using triac dimmer
- 120° wide beam angle
- CCT: 3000K 4000K  
5000K 5700K
- No UV/IR light
- Environment friendly, without Mercury or any other hazardous substances

## Application notes

- IP54 for indoor use only
- Professional electrician for installation only
- Switch off before installation
- Do not touch when in use
- Keep away from hot steam and corrosive gas

## Application Areas

It is designed for general lighting applications in office, supermarket, shop, school, hotel, etc. It is also widely used for public areas, such as stairway, lobby, reception, corridors etc.

## Certificate

**CE** **RoHS** **SAA**



# Product Information

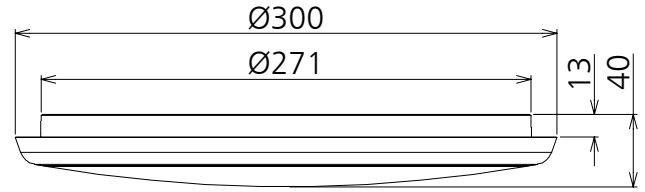

## Technical Specifications

Model	Voltage	Power	Power Factor	Lumen (±5%)	Beam angle	CCT	Lifespan	CRI	Dimmable	Dimension
UP-AL08-12-30W	AC230V	30W	≥0.9	2760	120°	3000K	40000h	≥80	No	Ø300*40mm
UP-AL08-12-30W	AC230V	30W	≥0.9	3060	120°	4000K	40000h	≥80	No	Ø300*40mm
UP-AL08-12-30W	AC230V	30W	≥0.9	3090	120°	5000K	40000h	≥80	No	Ø300*40mm
UP-AL08-12-30W	AC230V	30W	≥0.9	3090	120°	5700K	40000h	≥80	No	Ø300*40mm
UP-AL08-12-30W-D	AC230V	30W	≥0.9	2700	120°	3000K	40000h	≥80	Yes	Ø300*40mm
UP-AL08-12-30W-D	AC230V	30W	≥0.9	2970	120°	4000K	40000h	≥80	Yes	Ø300*40mm
UP-AL08-12-30W-D	AC230V	30W	≥0.9	3000	120°	5000K	40000h	≥80	Yes	Ø300*40mm
UP-AL08-12-30W-D	AC230V	30W	≥0.9	3000	120°	5700K	40000h	≥80	Yes	Ø300*40mm

## Driver data Sheet

Driver data	DIM	Non-dim
Input rated Voltage	AC230V	AC230V
Frequency	50Hz	50Hz
Input Voltage	AC200-240V	AC200-240V
Efficiency	≥88%	≥88%
No load wattage	≤0.5W	≤0.4W
Total load Wattage	30W±5%	30W±5%
Power Factor	≥0.9	≥0.9
Rated input current	≤0.17A	≤0.17A
Full load output Voltage	60-75V	60-75V
Rated output current	370mA	370mA
Output current range	370mA±5%	370mA±5%
Power tolerance	±5%	±5%
Current output tolerance	±5%	±5%
Dimming range	8%-100%	—
Dimmer	Triac dimmers	—
Withstand voltage	AC3750V	AC3750V
Short circuit protection	PASS	PASS
Over voltage protection	PASS	PASS
Over temperature protection	PASS	PASS

## Fixture Compatibility

Rated Wattage	Electrical Classification	Ingress Protection	Operating Temp	Operating Humidity	Storage Temp
30W	II	IP54	-20°C~45°C	0~90%	-20°C~65°C

# Spectral Distribution

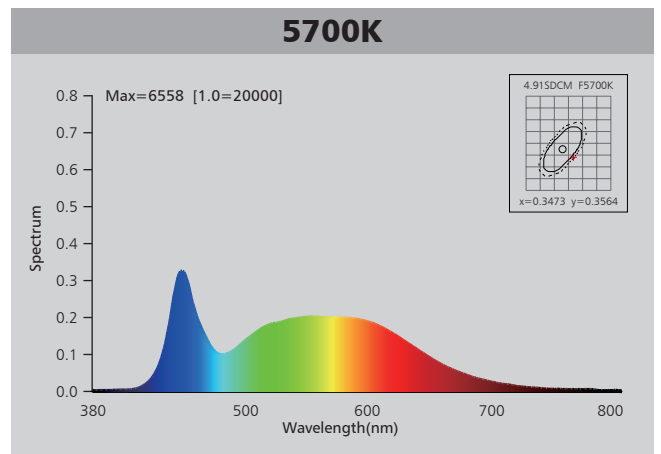
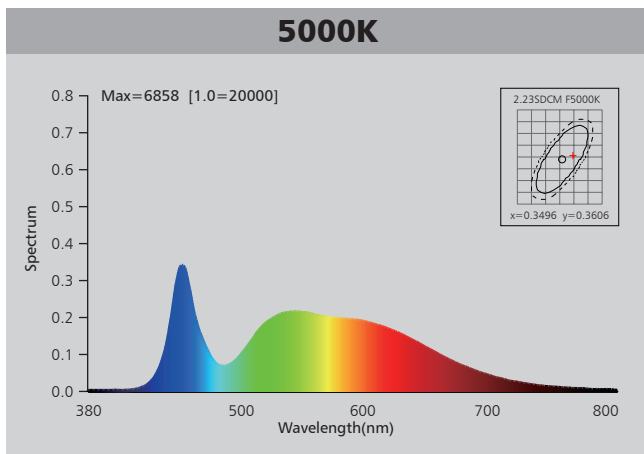
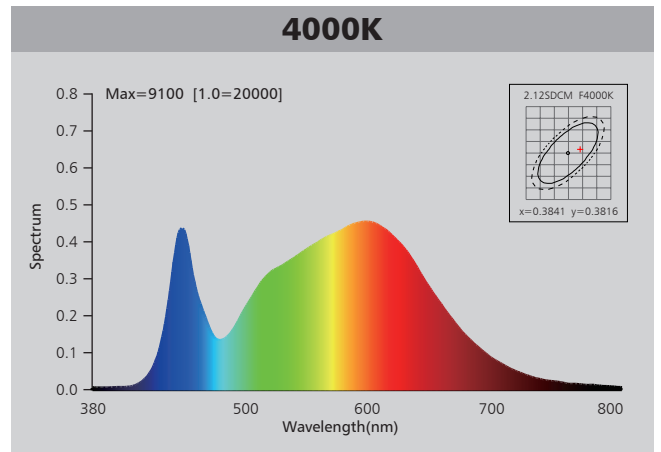
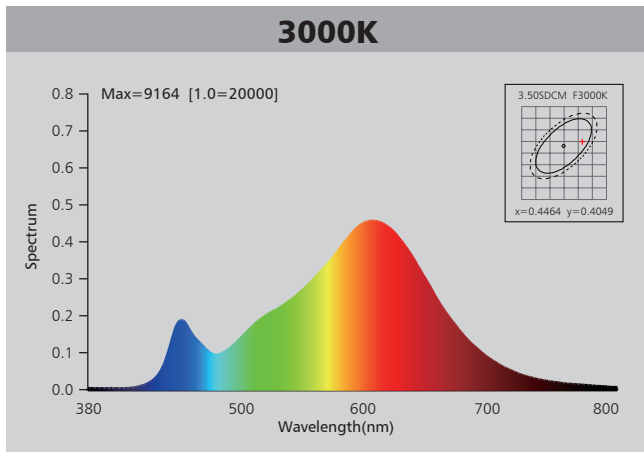

# Photometric Diagram

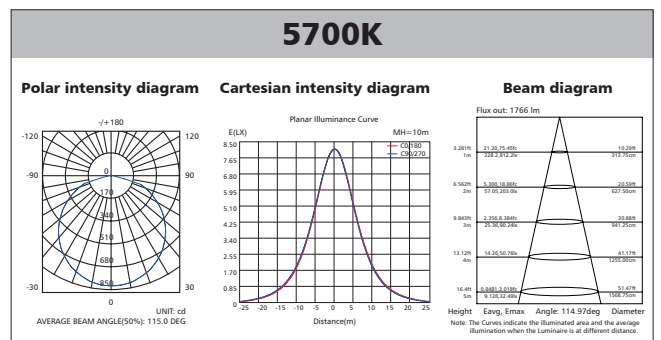
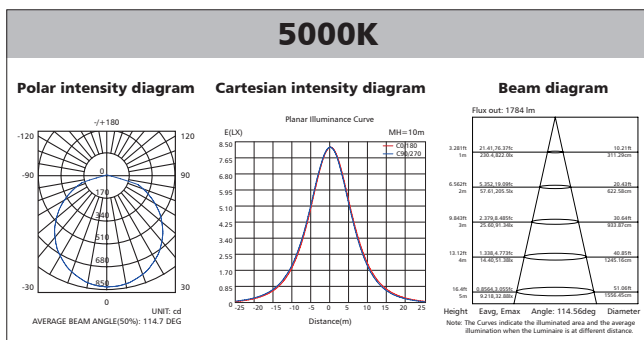
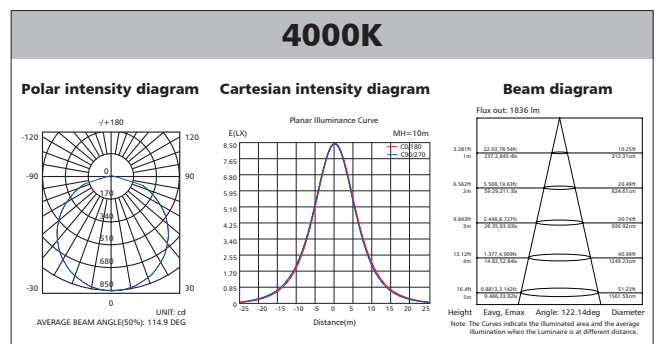
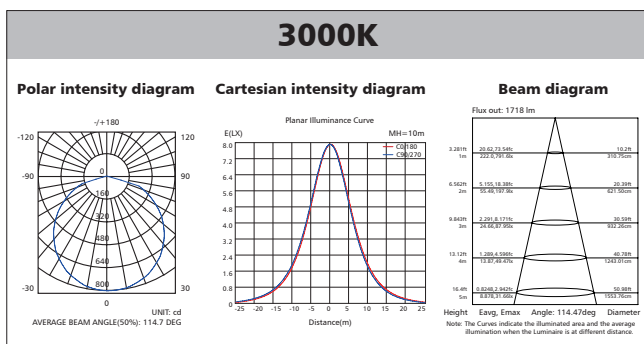

# Polar Diagram Comparison

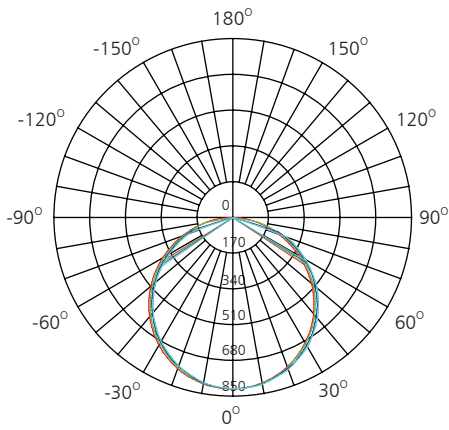

UNIT: cd

- C0/180, 115.0 deg
- C30/210, 115.1 deg
- C60/240, 115.1 deg
- C90/270, 114.9 deg

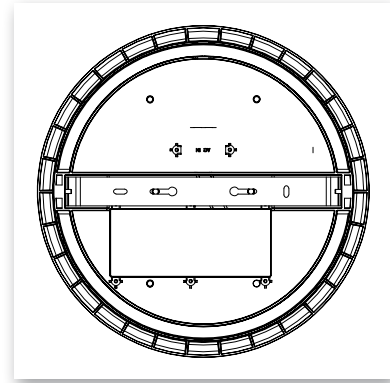

AVERAGE BEAM ANGLE (50%): 115.0DEG

# Driver lifetime & LED light decay rate

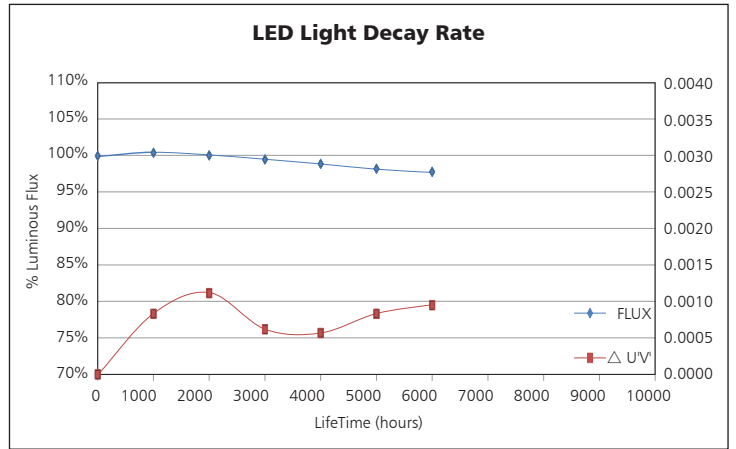
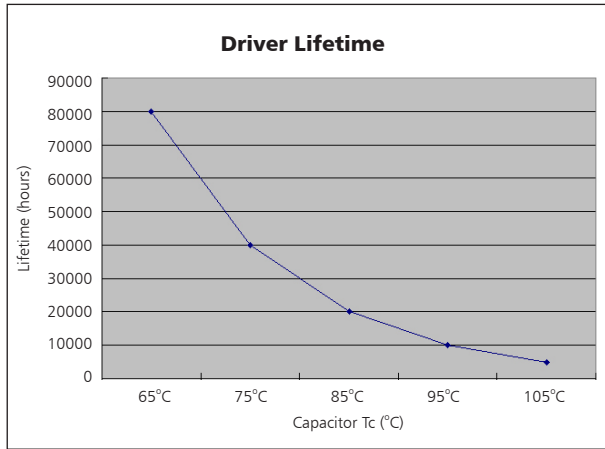

# Temperature

- The testing is operated at 25°C
- The lifetime of capacitor, minimum of 5,000 hours if operated at 105°C, will be doubled whenever the temperature drops 10°C
- The highest withstand temperature of IC, MOS could be 120°C
- The highest withstand temperature of LED junction temperature is 150°C

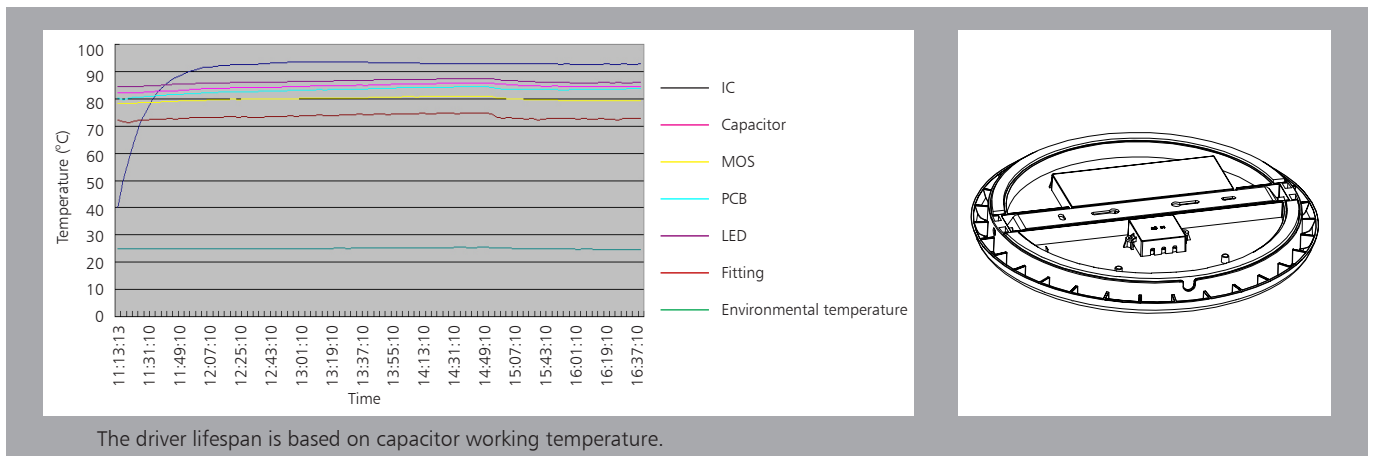

The driver lifespan is based on capacitor working temperature.

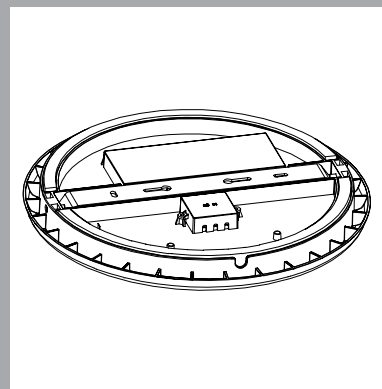

# Installation

1. Take out ceiling light and accessory pack from box

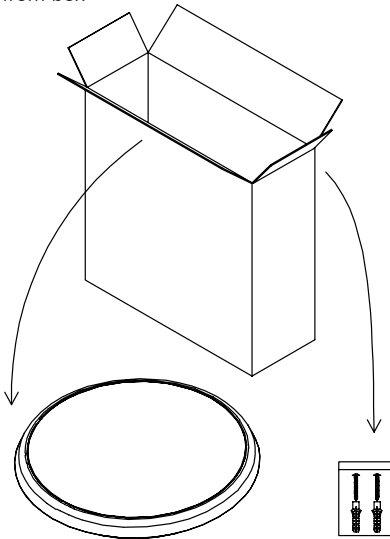

2. Knock-in the plastic anchor into ceiling

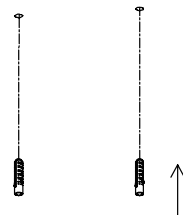

3. Remove screw, take out bracket

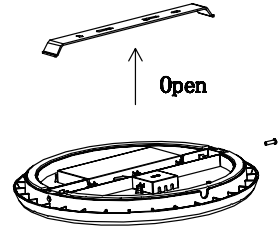

4. Fix bracket with screw into the ceiling

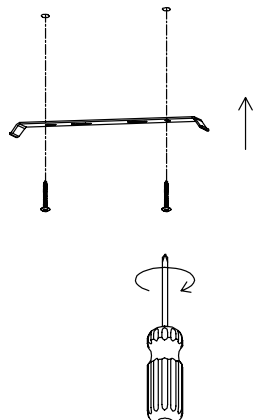

5. Open junction box, wire "L" "N" to terminal block and mount ceiling light into the right place

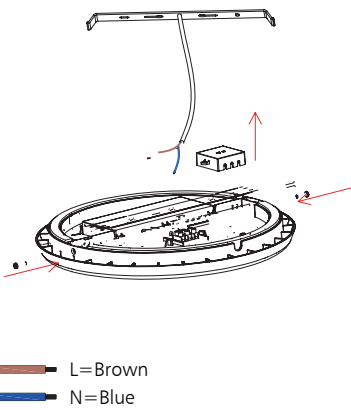

— L=Brown  
— N=Blue

6. Switch on

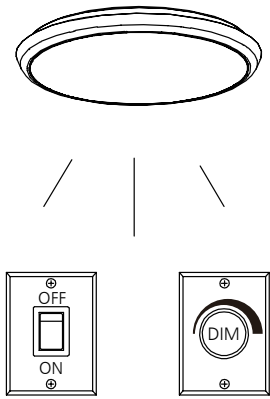

# Packaging Information

	SIZE(CM)	N.W/pc (KGS)	G.W.(KGS)	Q'TY(PCs)
Carton	53*32.5*33.5	1.03	12.5	10

	CTNS	Q'TY(PCs)	VOLUME(CBM)
20" standard container	477	4770	28
40" standard container	954	9540	56

