



UPSHINE[®]



Technical Application
Guide for UP-SHINE
LED Ceiling light

UP-AL08-12-25W

Introduction

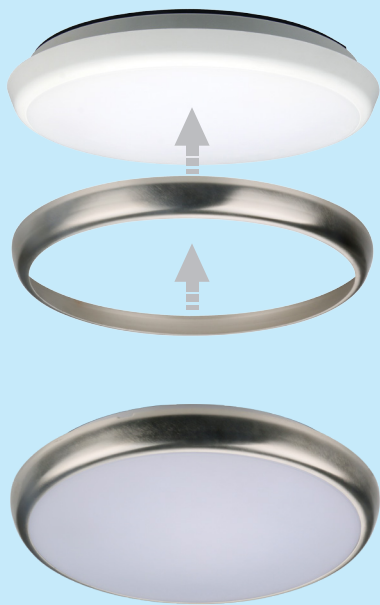

Up-shine surface mounted ceiling light adopts high lumen SMD LED, fire-rated PC diffuser with even light output. IP54 waterproof structural design, it is an ideal replacement for damp locations. driver in top branded component with triac dimmable function, 120°wide beam angle.

- Up to 70% energy saving compared to standard CFL
- Long lifetime of 40,000 hours
- Dimmable when using triac dimmer
- 120° wide beam angle
- CCT: 3000K 4000K
5000K 5700K
- No UV/IR light
- Environment friendly, without Mercury or any other hazardous substances

Application notes

- IP54 for indoor use only
- Professional electrician for installation only
- Switch off before installation
- Do not touch when in use
- Keep away from hot steam and corrosive gas

Application Areas

It is designed for general lighting applications in office, supermarket, shop, school, hotel, etc. It is also widely used for public areas, such as stairway, lobby, reception, corridors etc.

Certificate



Product Information

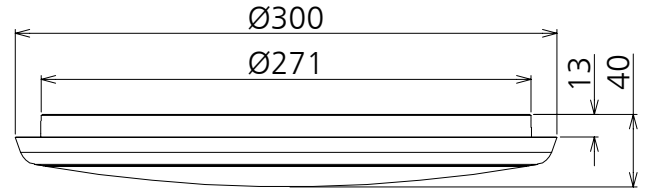

Technical Specifications

Model	Voltage	Power	Power Factor	Lumen (±5%)	Beam angle	CCT	Lifespan	CRI	Dimmable	Dimension
UP-AL08-12-25W	AC230V	25W	≥0.9	2300	120°	3000K	40000h	≥80	No	Ø300*40mm
UP-AL08-12-25W	AC230V	25W	≥0.9	2550	120°	4000K	40000h	≥80	No	Ø300*40mm
UP-AL08-12-25W	AC230V	25W	≥0.9	2575	120°	5000K	40000h	≥80	No	Ø300*40mm
UP-AL08-12-25W	AC230V	25W	≥0.9	2575	120°	5700K	40000h	≥80	No	Ø300*40mm
UP-AL08-12-25W-D	AC230V	25W	≥0.9	2250	120°	3000K	40000h	≥80	Yes	Ø300*40mm
UP-AL08-12-25W-D	AC230V	25W	≥0.9	2475	120°	4000K	40000h	≥80	Yes	Ø300*40mm
UP-AL08-12-25W-D	AC230V	25W	≥0.9	2500	120°	5000K	40000h	≥80	Yes	Ø300*40mm
UP-AL08-12-25W-D	AC230V	25W	≥0.9	2500	120°	5700K	40000h	≥80	Yes	Ø300*40mm

Driver data Sheet

Driver data	DIM	Non-dim
Input rated Voltage	AC230V	AC230V
Frequency	50Hz	50Hz
Input Voltage	AC200-240V	AC200-240V
Efficiency	≥88%	≥88%
No load wattage	≤0.5W	≤0.4W
Total load Wattage	25W±5%	25W±5%
Power Factor	≥0.9	≥0.9
Rated input current	≤0.14A	≤0.14A
Full load output Voltage	60-75V	60-75V
Rated output current	320mA	320mA
Output current range	320mA±5%	320mA±5%
Power tolerance	±5%	±5%
Current output tolerance	±5%	±5%
Dimming range	8%-100%	—
Dimmer	Triac dimmers	—
Short circuit protection	PASS	PASS
Over voltage protection	PASS	PASS
Over temperature protection	PASS	PASS
Withstand voltage	AC3750V	AC3750V

Fixture Compatibility

Rated Wattage	Electrical Classification	Ingress Protection	Operating Temp	Operating Humidity	Storage Temp
25W	II	IP54	-20°C~45°C	0~90%	-20°C~65°C

Spectral Distribution

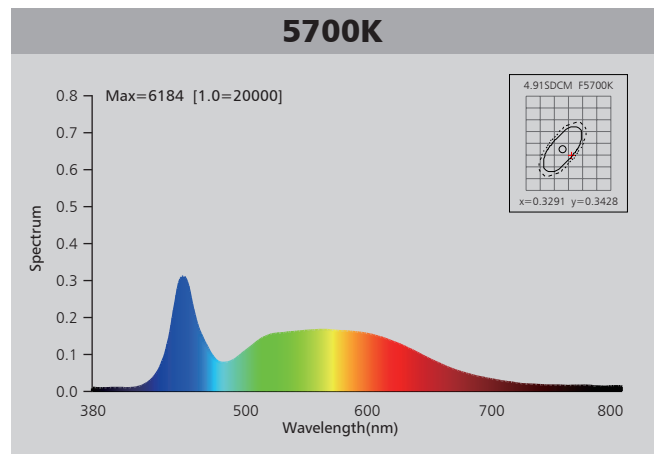
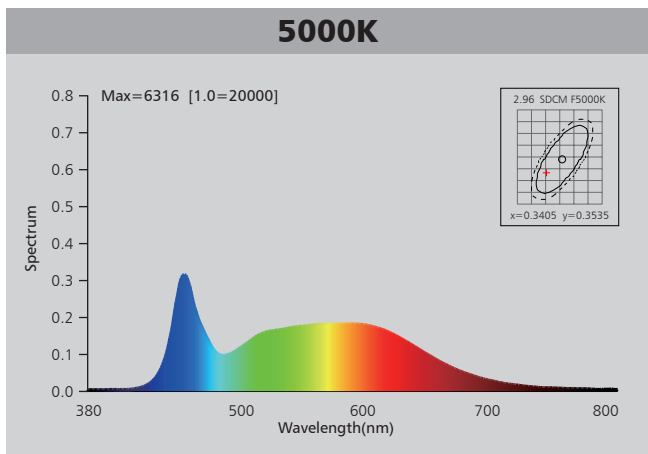
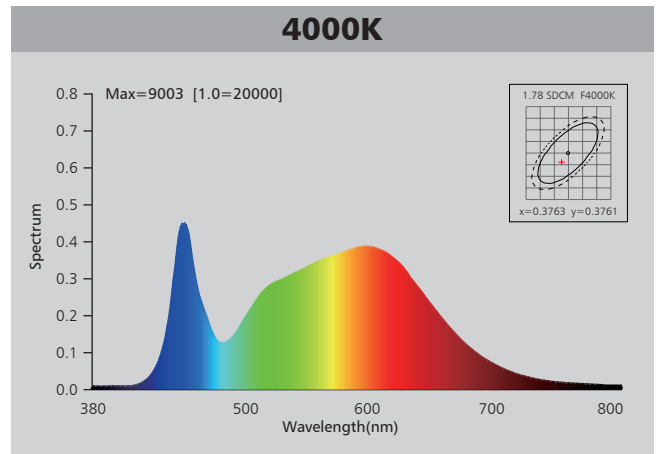
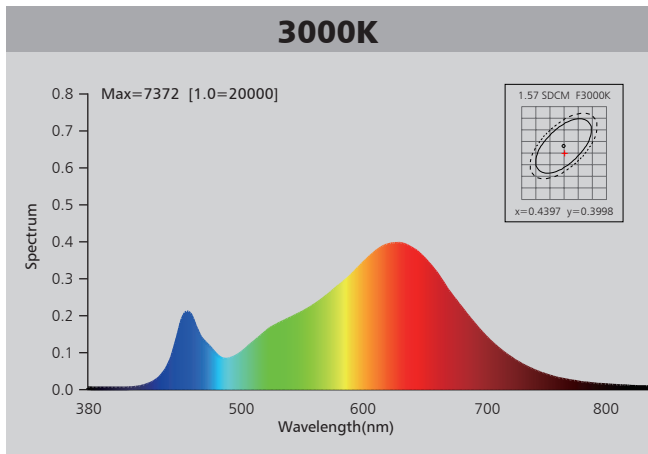

Photometric Diagram

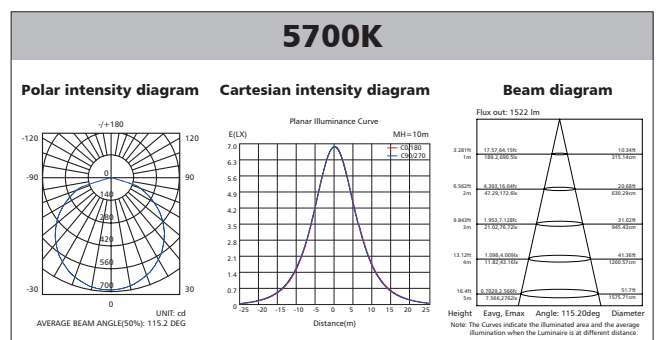
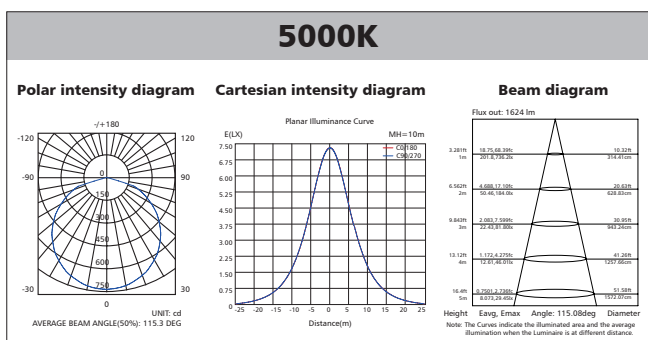
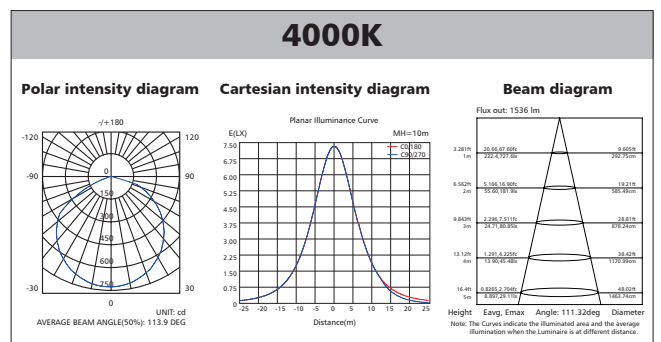
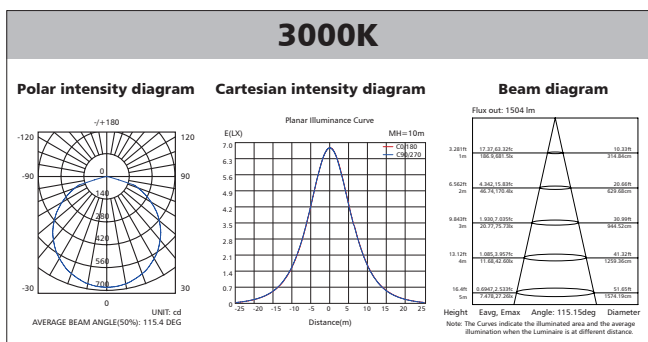

Polar Diagram Comparison

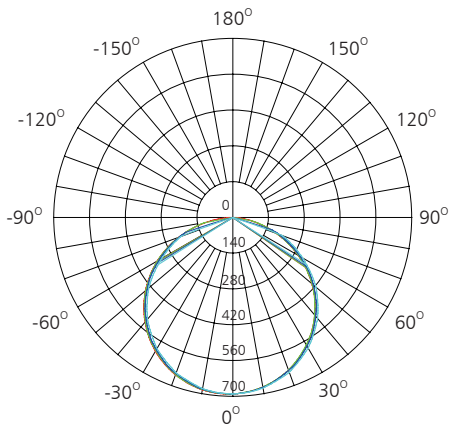

UNIT: cd

- C0/180, 115.2 deg
- C30/210, 115.2 deg
- C60/240, 115.2 deg
- C90/270, 115.1 deg

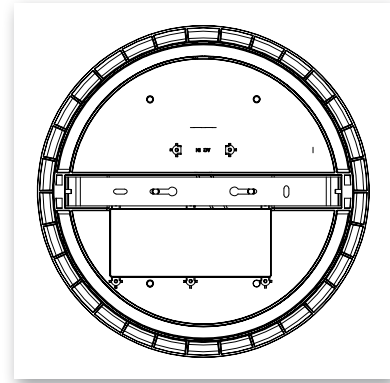

AVERAGE BEAM ANGLE (50%): 115.2 DEG

Driver lifetime & LED light decay rate

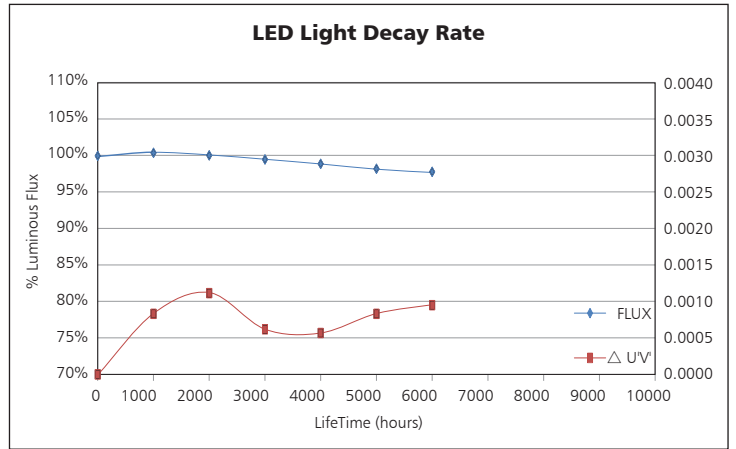
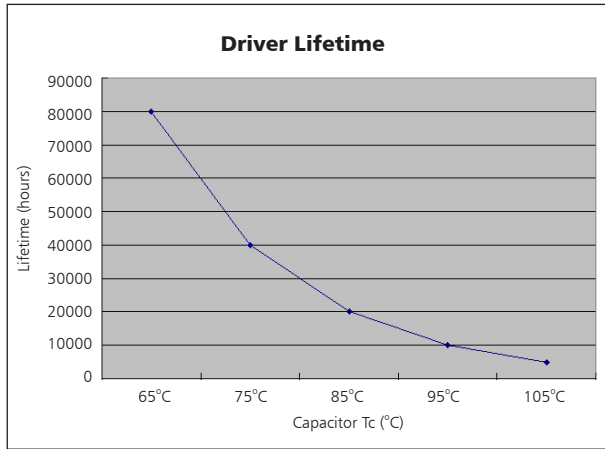

Temperature

- The testing is operated at 25°C
- The lifetime of capacitor, minimum of 5,000 hours if operated at 105°C, will be doubled whenever the temperature drops 10°C
- The highest withstand temperature of IC, MOS could be 120°C
- The highest withstand temperature of LED junction temperature is 150°C

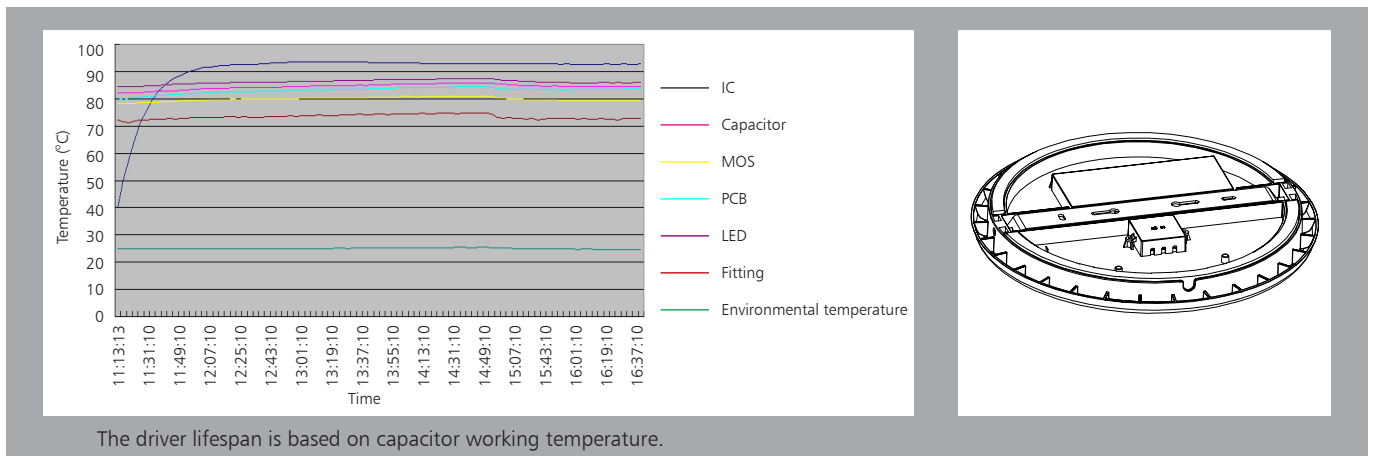

The driver lifespan is based on capacitor working temperature.

Installation

1. Take out ceiling light and accessory pack from box

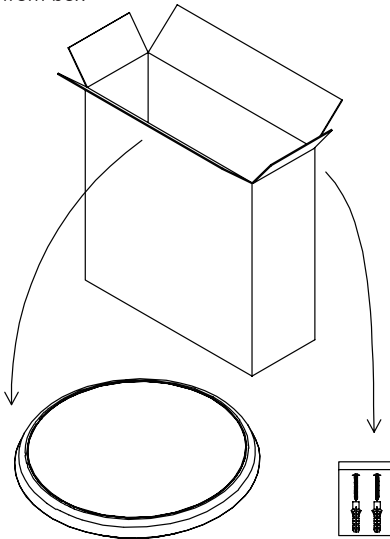

2. Knock-in the plastic anchor into ceiling

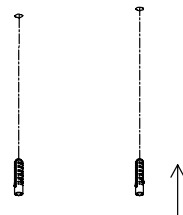

3. Remove screw, take out bracket

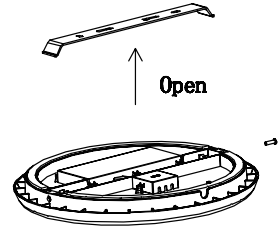

4. Fix bracket with screw into the ceiling

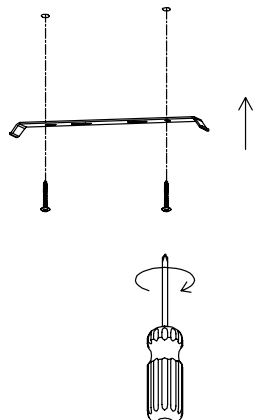

5. Open junction box, wire "L" "N" to terminal block and mount ceiling light into the right place

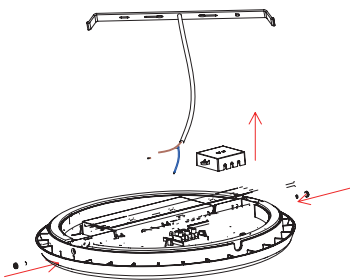

— L=Brown
— N=Blue

6. Switch on

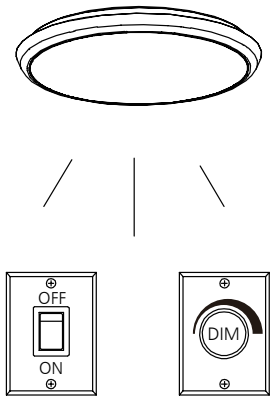

Packaging Information

	SIZE(CM)	N.W/pc (KGS)	G.W.(KGS)	Q'TY(PCs)
Carton	53*32.5*33.5	1.03	12.5	10

	CTNS	Q'TY(PCs)	VOLUME(CBM)
20" standard container	477	4770	28
40" standard container	954	9540	56

