

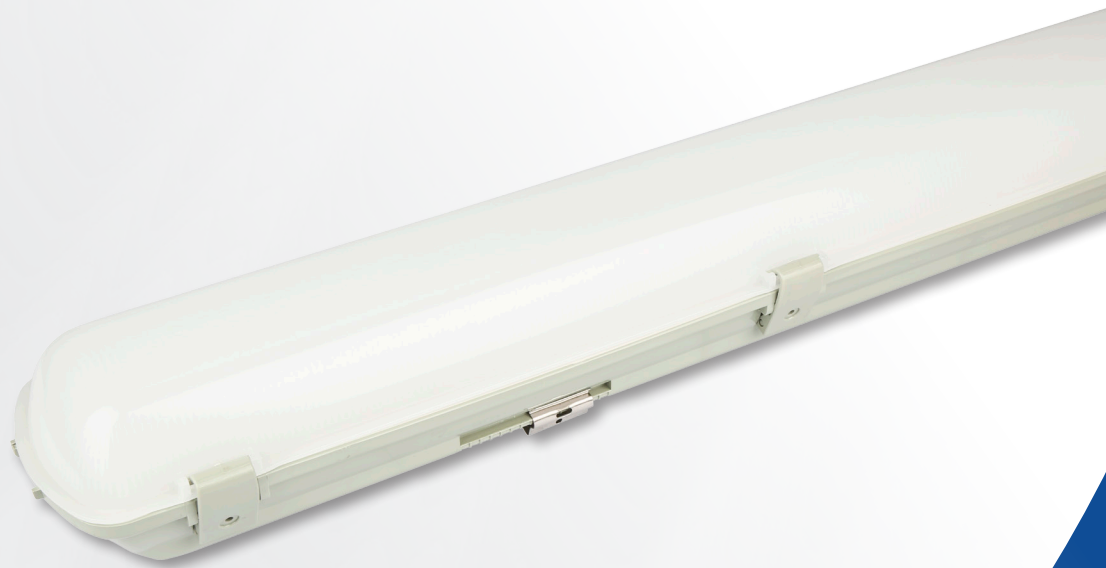

UPSHINE<sup>®</sup>



Technical Application  
Guide for UP-SHINE  
Tri-proof LED light  
UP-TRP02-600-20W

# Introduction



stainless steel buckle  
for optional



Tri-proof LED light adopts high lumen SMD light source, a compact high PF driver and insulated fireproof PC cover into a traditional tube replacement. The lampshade with, high transparency, soft&uniform light distribution; latch design make the lampshade disassembly and assembly easier; the natural-rubber seal ring has cable joint, dustproof waterproof rating as IP65.

Anti-corrosion, shock resistance, easy cleaning, energy saving and environmental protection.

- Up to 70% energy saving compared to standard CFL
- Long lifetime of 50,000 hours
- 120° wide beam angle
- CCT: 3000K 4000K 5000K 5700K
- No UV/IR light
- Environment friendly, without Mercury or any other hazardous substances

## Application notes

- IP65 for indoor use
- Professional electrician for installation only
- Switch off before installation
- Do not touch when in use

## Application Areas

Tri-proof LED light can be used in factory, warehouse, workshop, and other lighting area with high humidity and dusty places .

## Certificate

CE RoHS SAA

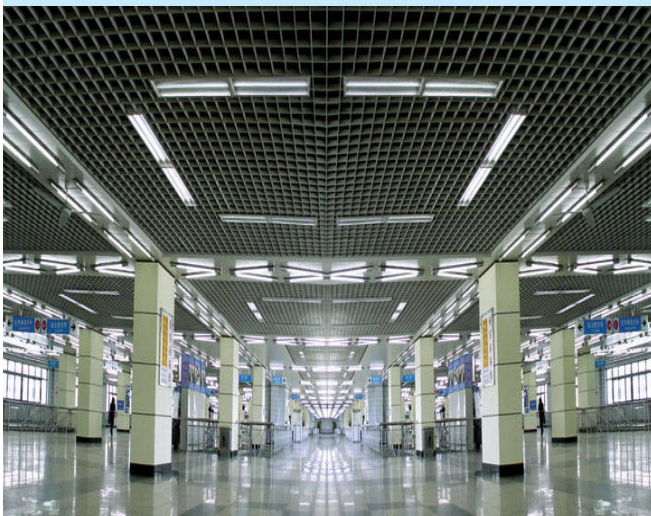

# Product Information

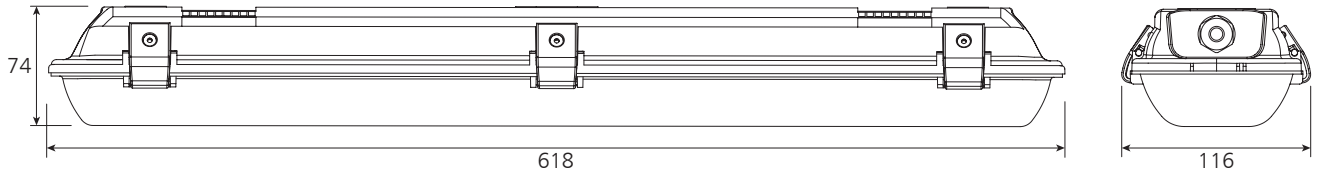

## Technical Specifications

Model	Voltage	Power	Power Factor	Lumen (±5%)	CCT	Beam angle	Lifespan	CRI	Dimmable	Dimension
UP-TRP02-600-20W	AC100-240V	20W	≥0.9	1700	3000K	120°	50,000h	≥80	No	618*116*74mm
				2000	4000K					
				1960	5000K					
				1900	5700K					

## Driver data Sheet

Driver data	Non-dim
Input rated Voltage	AC100-240V
Frequency	50/60Hz
Input Voltage	AC85-265V
Efficiency	≥85%
Total load Wattage	20W±1W
Power Factor	≥0.9
Rated input current	≤0.2A
Full load output Voltage	DC60-75V
Rated output current	230mA
Output current range	230mA±5%
Power tolerance	±5%
Current output tolerance	±5%
Short circuit protection	PASS
Over voltage protection	PASS
Over temperature protection	PASS
Withstand voltage	—

## Fixture Compatibility

Rated Wattage	Electrical Classification	Ingress Protection	Operating Temp	Operating Humidity	Storage Temp
20W	I	IP65	-20°C~45°C	0~90%	-20°C~65°C

# Spectral Distribution

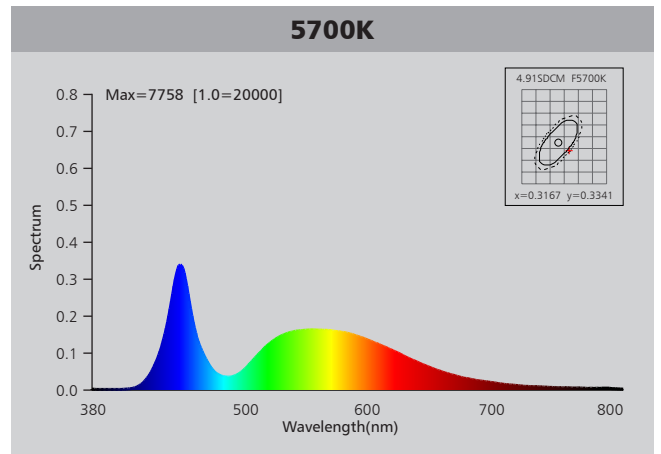
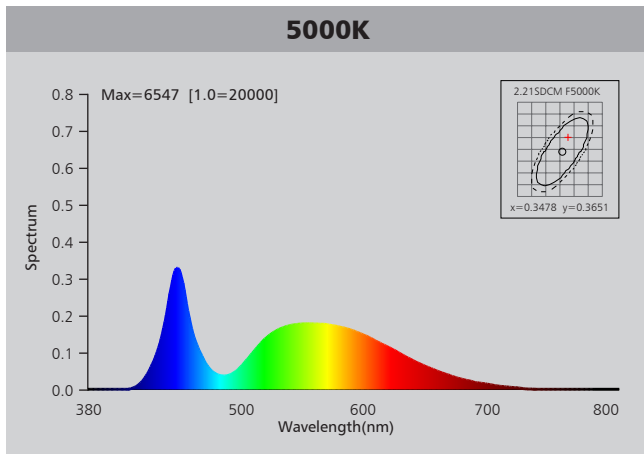
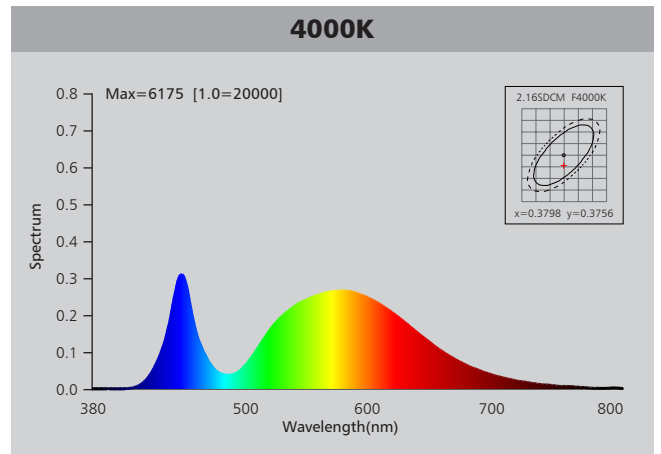
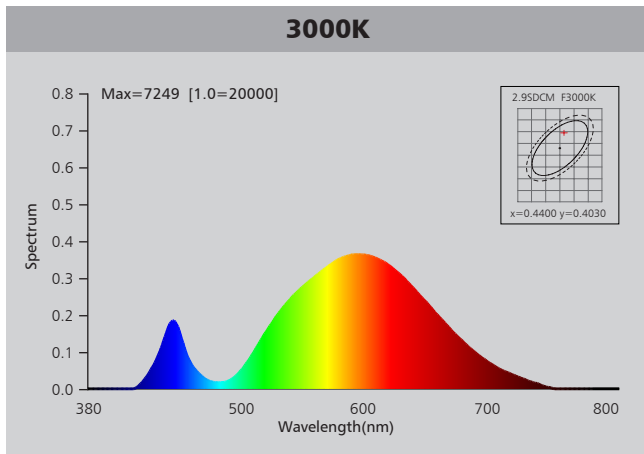

# Photometric Diagram

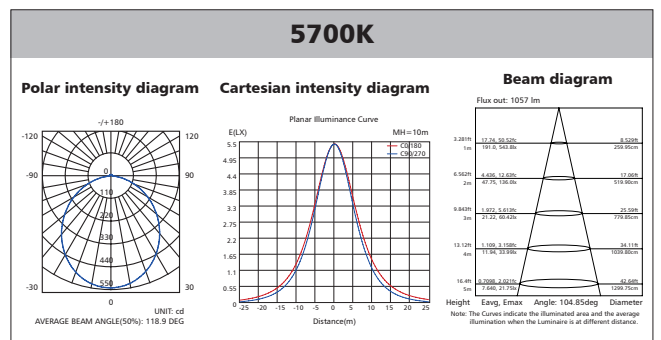
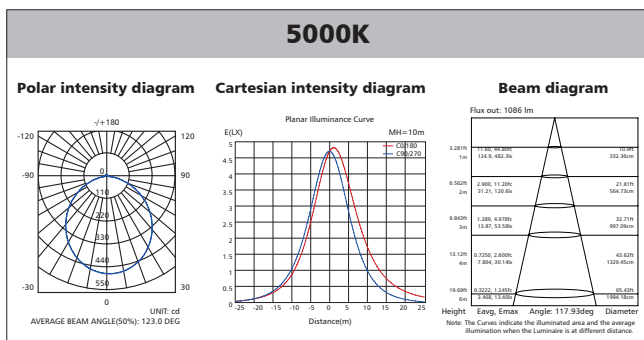
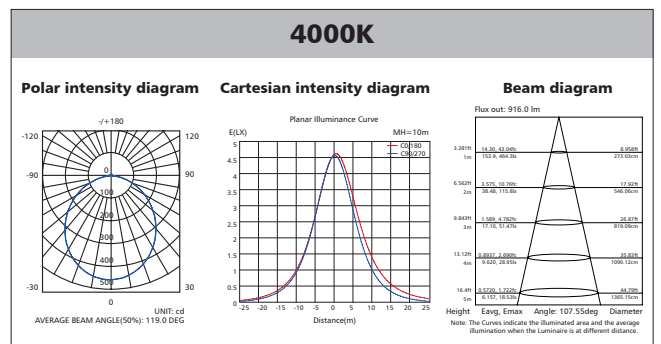
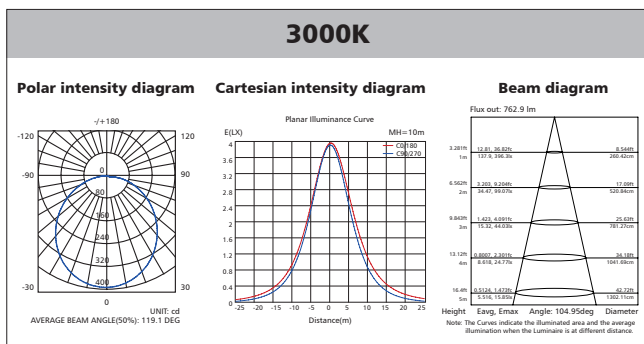

## Polar Diagram Comparison

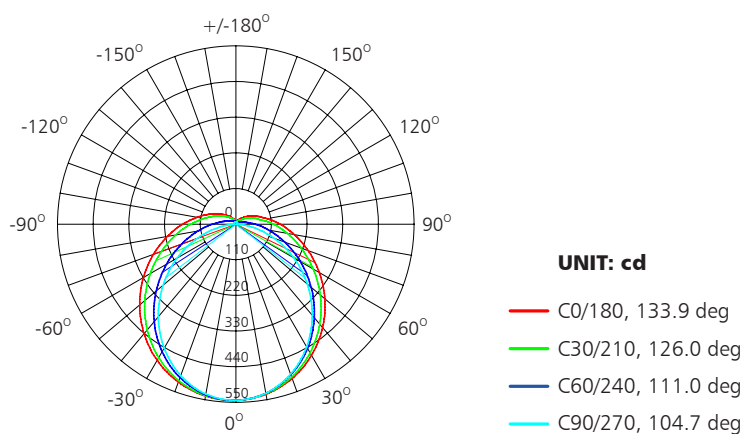

AVERAGE BEAM ANGLE (50%): 118.9DEG



## Driver lifetime & LED light decay rate

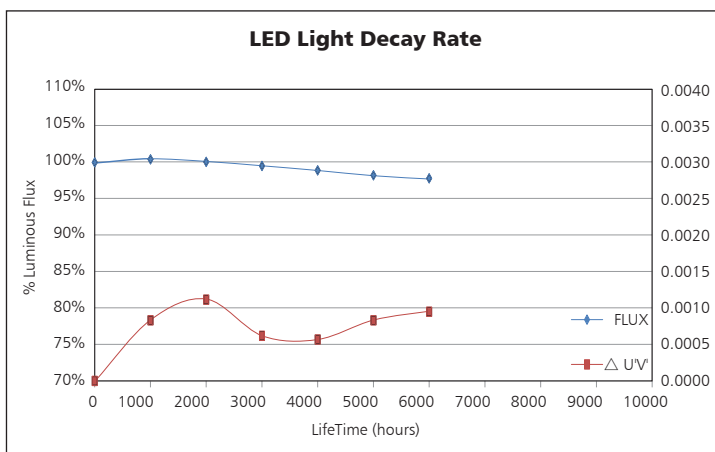
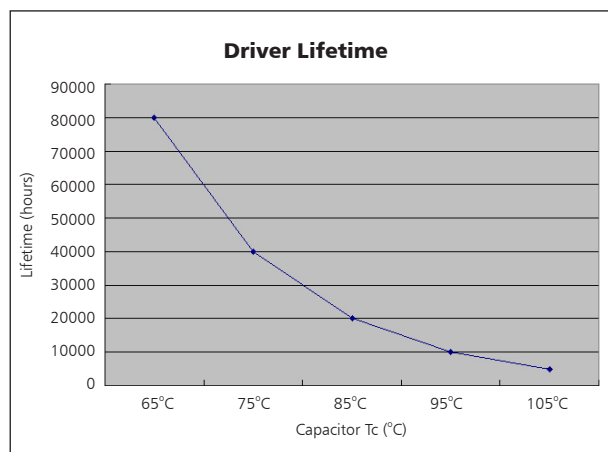

## Temperature

- The testing is operated at 25°C
- The lifetime of capacitor, minimum of 5,000 hours if operated at 105°C, will be doubled whenever the temperature drops 10°C
- The highest withstand temperature of IC, MOS could be 120°C
- The highest withstand temperature of LED junction temperature is 150°C

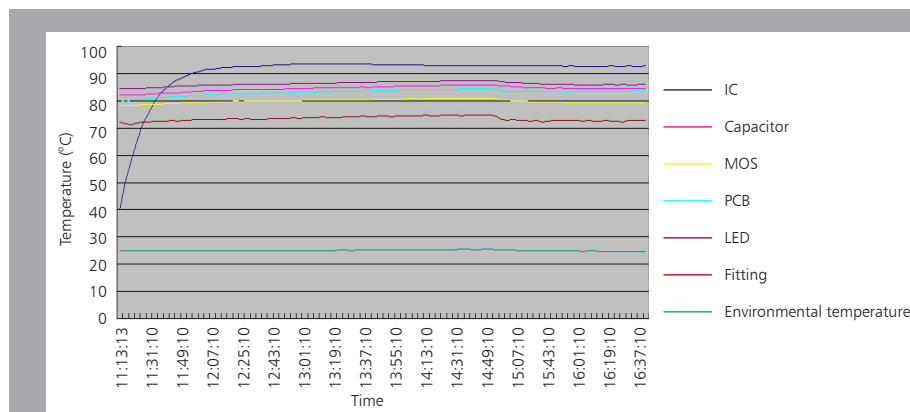

The driver lifespan is based on capacitor working temperature.

# Installation

## Suspended

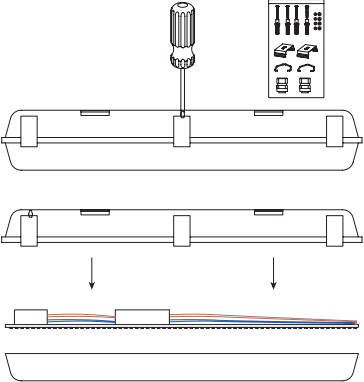
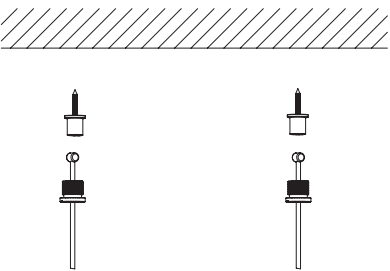
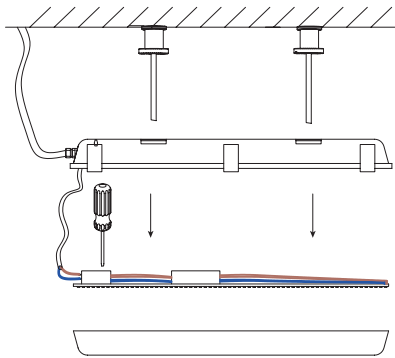
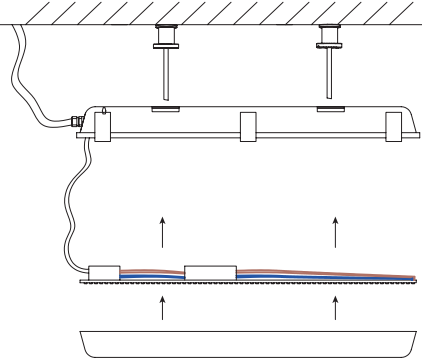
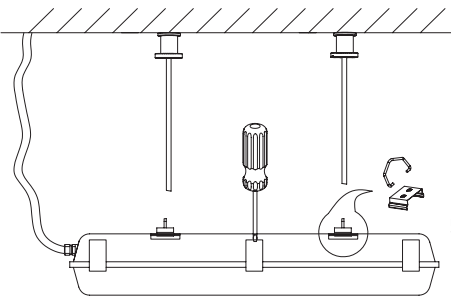
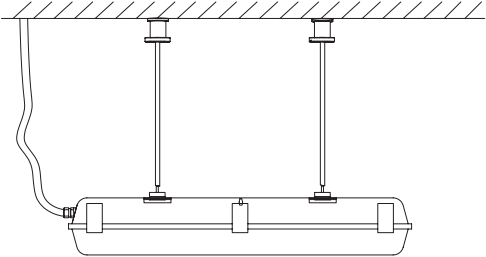
 <p>1. Open the lamp by screw driver, take out the accessory pack from the lamp.</p>	 <p>2. Cut off the power, fix the holders of suspending ropes on the ceiling.</p>
 <p>3. (a) Connect the AC cables to the terminal block (inside wire 1-2.5mm<sup>2</sup>); (b) Protect the PCB from being damaged in the whole installation process.</p> <p> <span style="color: brown;">—</span> L = BROWN  <span style="color: blue;">—</span> N = BLUE  <span style="color: yellowgreen;">—</span> ⊕ = YELLOW-GREEN         </p>	 <p>4. Assemble the lamp.</p>
 <p>5. Lock the lamp fixture with screws, fix the mounting brackets on the back of lamp.</p>	 <p>6. Connect the suspending ropes to the lamp.</p>

## Surface Mounted

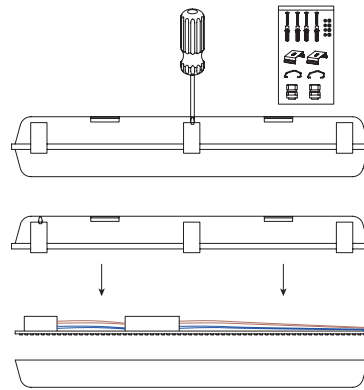
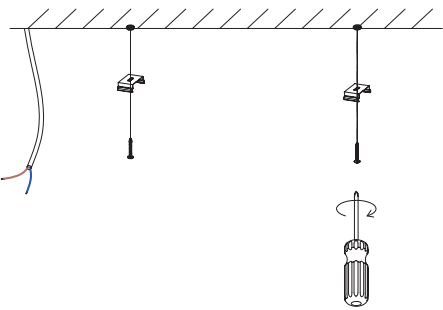
 <p>1. Open the lamp by screw driver, take out the accessory pack from the lamp.</p>	 <p>2. Cut off the power, fix the mounting brackets on the ceiling.</p>
---	---

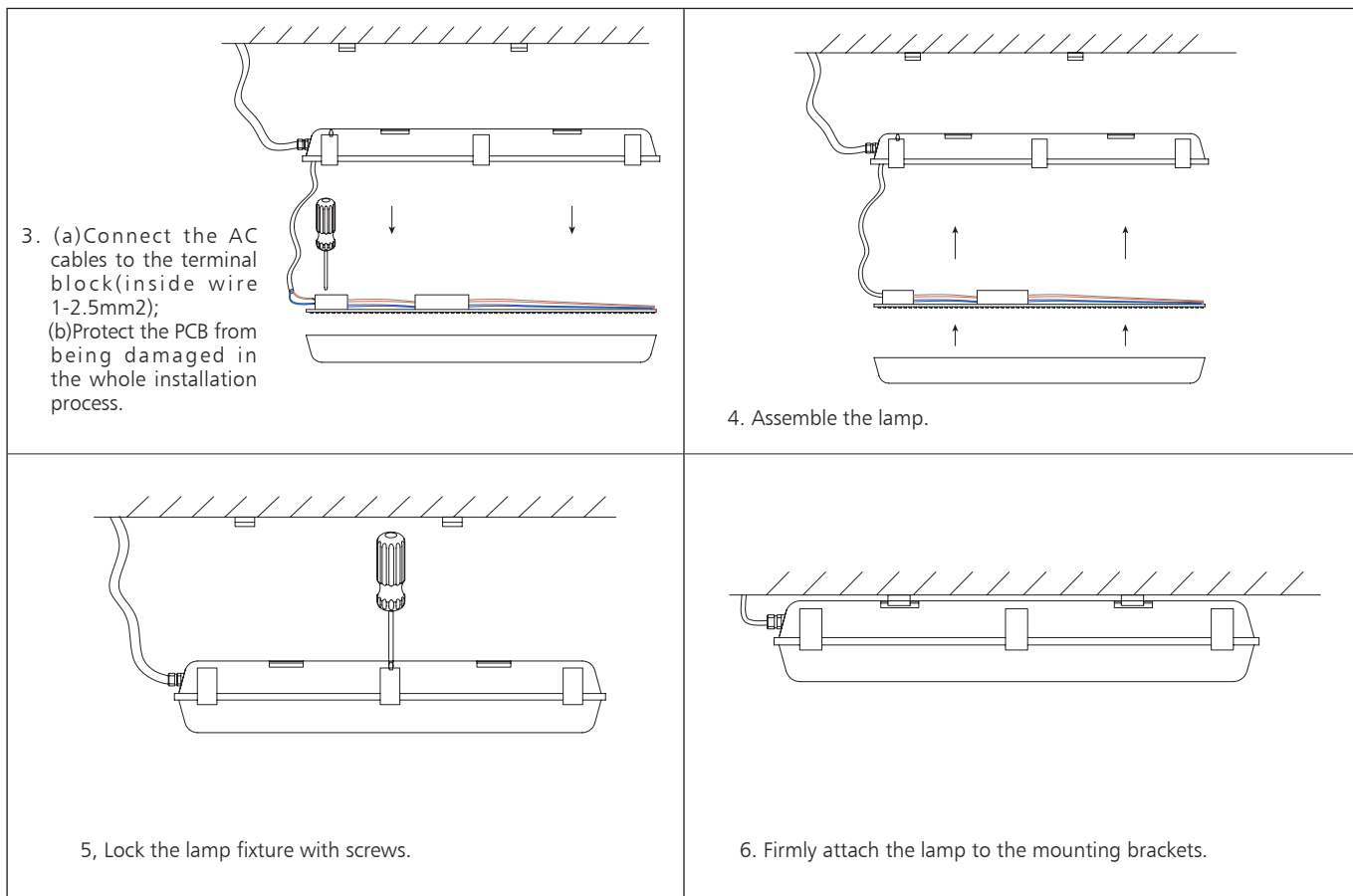

## Packaging Information

	SIZE(CM)	N.W/pc (KGS)	G.W.(KGS)	Q'TY(PCS)
Carton	64.5*24.5*34.5	1.15	10.3	8

	CTNS	Q'TY(PCS)	VOLUME(CBM)
20" standard container	500	4000	28
40" standard container	1000	8000	56

