



Up-shine[®] Lighting



Technical Application
Guide for UP-SHINE
LED Batten

UP-DB21A-600-20W

Introduction

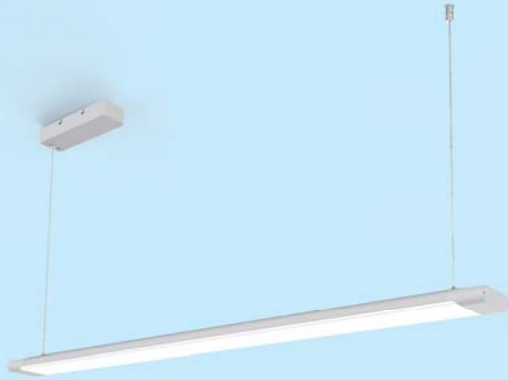

Up-shine batten realizes elegant design, low cost, super slim construction and superior capability, aluminium profile body for good thermal dissipate, surface color treatment is customizable. Easy installation provided with surface mounted and suspended. It is a high efficient and low cost product with quite large potential market.

- Up to 70% energy saving compared to standard CFL
- Long lifetime of 50,000 hours
- 120° wide beam angle
- CCT: 3000K 4000K 5000K 5700K
- No UV/IR light
- Environment friendly, without Mercury or any other hazardous substances
- External Driver

Application notes

- IP20 for indoor use only
- The lamp must be installed by professional electrician
- Ensure the power supply is switched off before fitting this product
- Do not touch the lamp when in use
- Keep away from hot steam and corrosive gas

Application Areas

Widely used in office, meeting room, hotel, school etc.

Certificate



Product Information

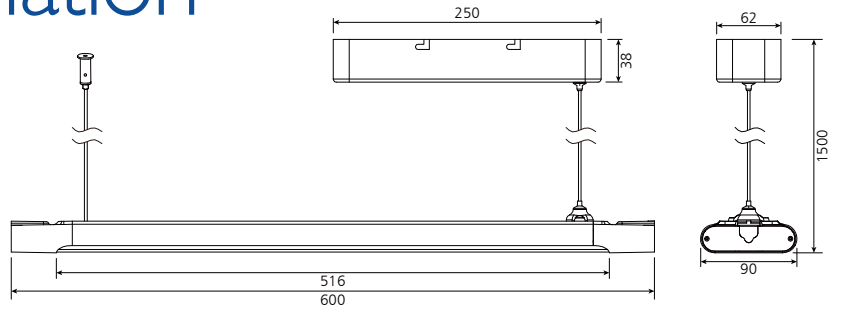

Technical Specifications

Model	Voltage	Power	Power Factor	Lumen (±5%)	Beam angle	CCT	Lifespan	CRI	Dimmable	Dimension
UP-DB21A-600-20W	AC230V	20W	≥0.9	1980	120°	3000K	50000h	≥80	No	L600*W90*H30mm
UP-DB21A-600-20W	AC230V	20W	≥0.9	2200	120°	4000K	50000h	≥80	No	L600*W90*H30mm
UP-DB21A-600-20W	AC230V	20W	≥0.9	2000	120°	5000K	50000h	≥80	No	L600*W90*H30mm
UP-DB21A-600-20W	AC230V	20W	≥0.9	1920	120°	5700K	50000h	≥80	No	L600*W90*H30mm
UP-DB21A-600-20W-D	AC230V	20W	≥0.9	1940	120°	3000K	50000h	≥80	Yes	L600*W90*H30mm
UP-DB21A-600-20W-D	AC230V	20W	≥0.9	2120	120°	4000K	50000h	≥80	Yes	L600*W90*H30mm
UP-DB21A-600-20W-D	AC230V	20W	≥0.9	1960	120°	5000K	50000h	≥80	Yes	L600*W90*H30mm
UP-DB21A-600-20W-D	AC230V	20W	≥0.9	1900	120°	5700K	50000h	≥80	Yes	L600*W90*H30mm

Driver data Sheet

Driver data	DIM	Main Power
Input rated Voltage	AC230V	AC230V
Frequency	50Hz	50Hz
Input Voltage	AC200-240V	AC200-240V
Efficiency	≥85%	≥85%
Total load Wattage	20W±5%	20W±5%
Power Factor	≥0.9	≥0.9
Rated input current	≤0.12A	≤0.12A
Full load output Voltage	DC23-40V	DC27-40V
Rated output current	500mA	550mA
Output current range	500mA±5%	550mA±5%
Power tolerance	±5%	±5%
Current output tolerance	±5%	±5%
Dimming range	8%-100%	—
Dimmer	Triac dimmers	—
Short circuit protection	PASS	PASS
Over voltage protection	PASS	PASS
Over temperature protection	PASS	PASS
THD	≤18%	≤18%
Withstand voltage	—	—

Fixture Compatibility

Rated Wattage	Electrical Classification	Ingress Protection	Operating Temp	Operating Humidity	Storage Temp
20W	I	IP20	-20°C~45°C	0~90%	-20°C~65°C

Spectral Distribution

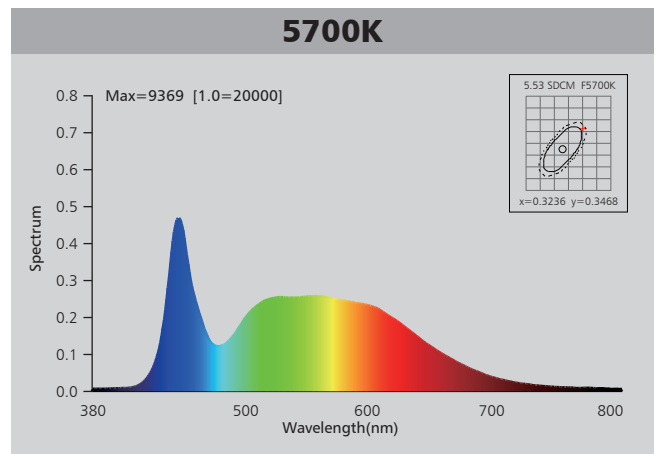
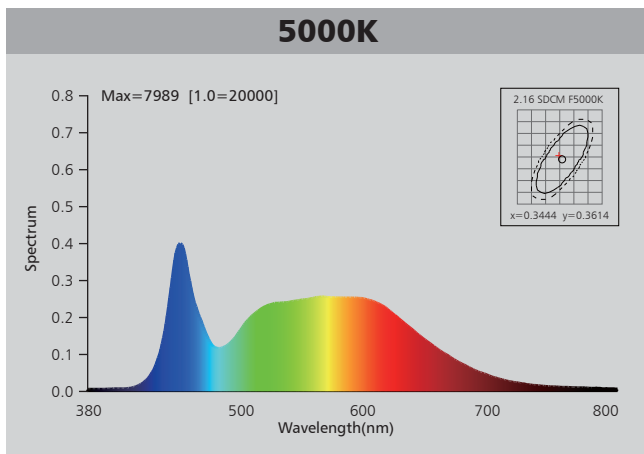
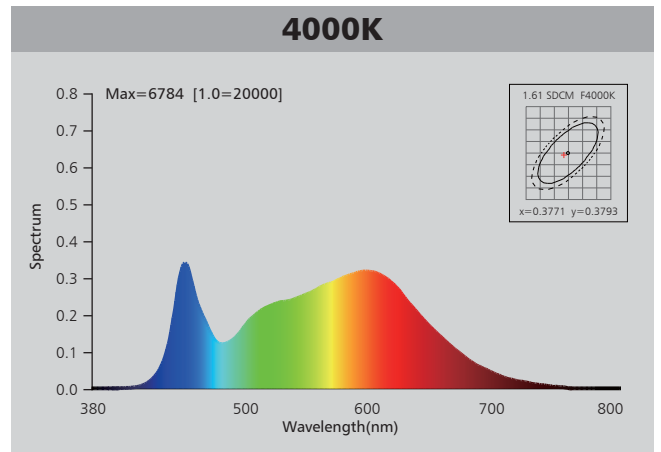
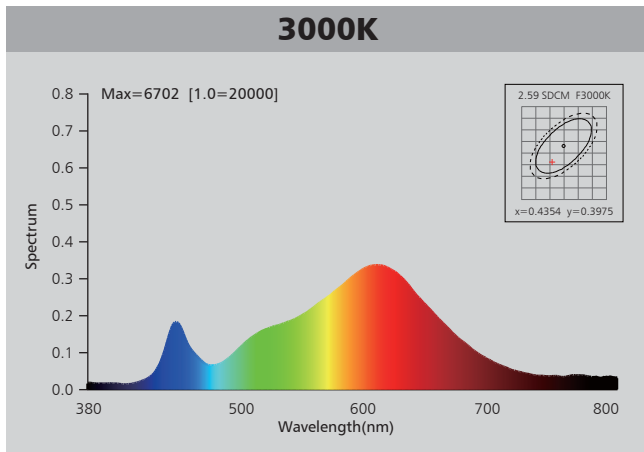

Photometric Diagram

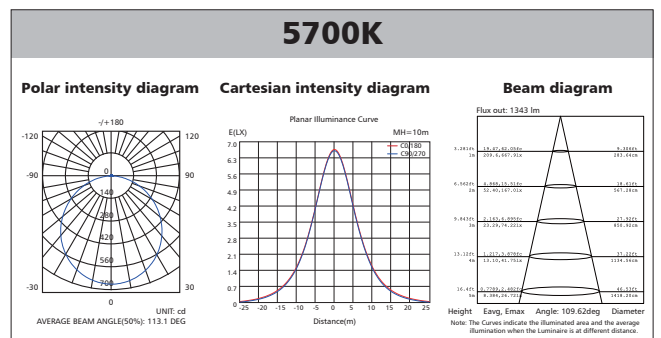
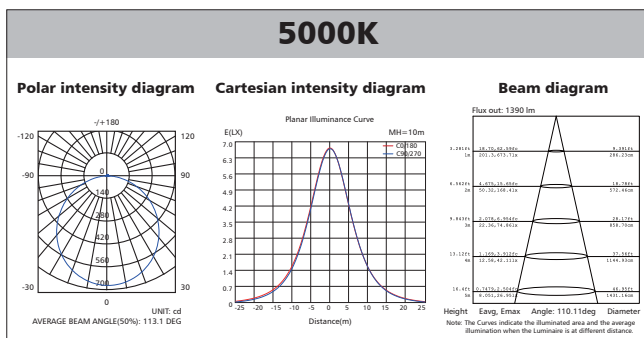
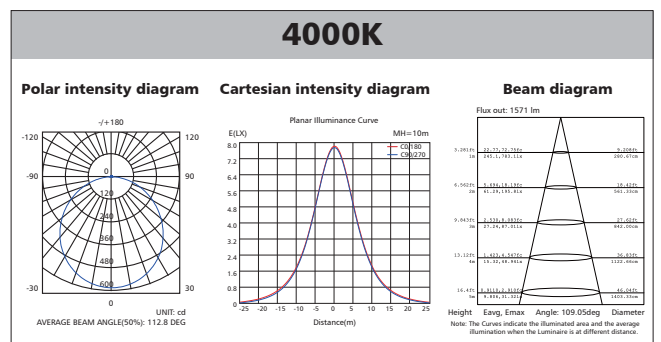
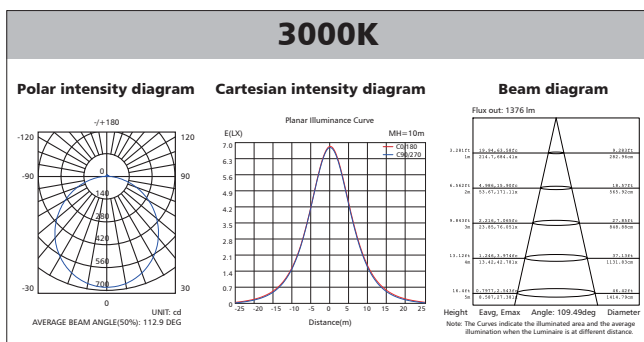

Polar Diagram Comparison

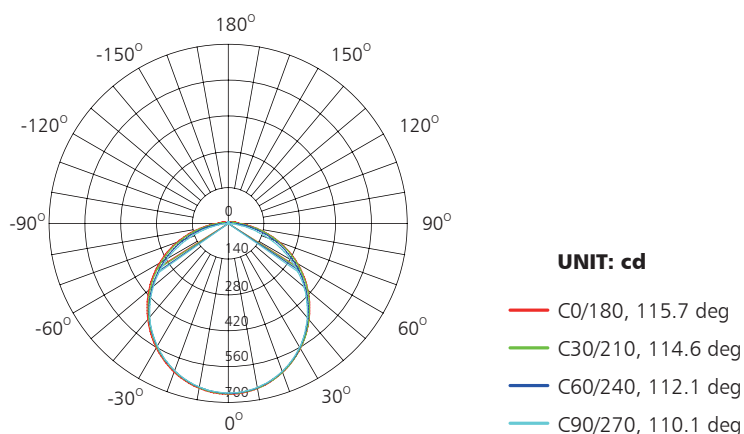

AVERAGE BEAM ANGLE (50%): 113.1DEG

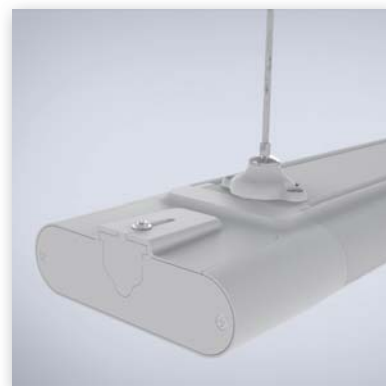

Driver lifetime & LED light decay rate

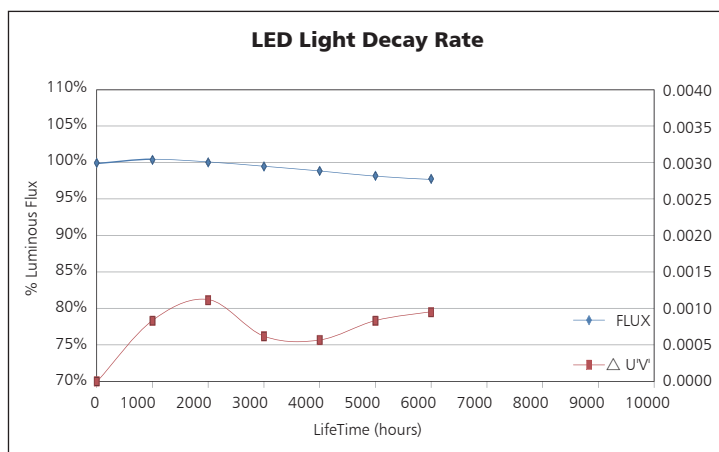
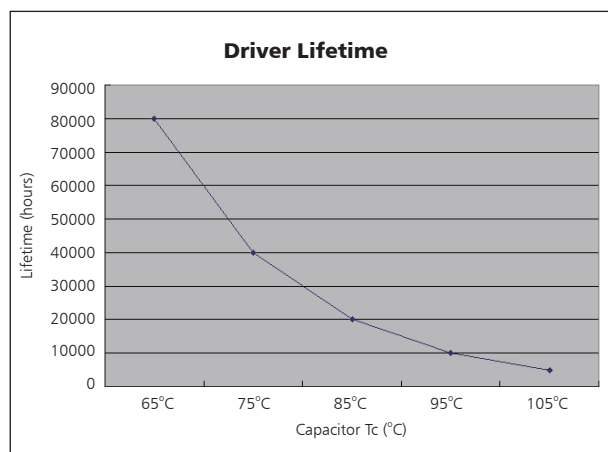

Temperature

- The testing is operated at 25°C
- The lifetime of capacitor, minimum of 5,000 hours if operated at 105°C, will be doubled whenever the temperature drops 10°C
- The highest withstand temperature of IC, MOS could be 120°C
- The highest withstand temperature of LED junction temperature is 150°C

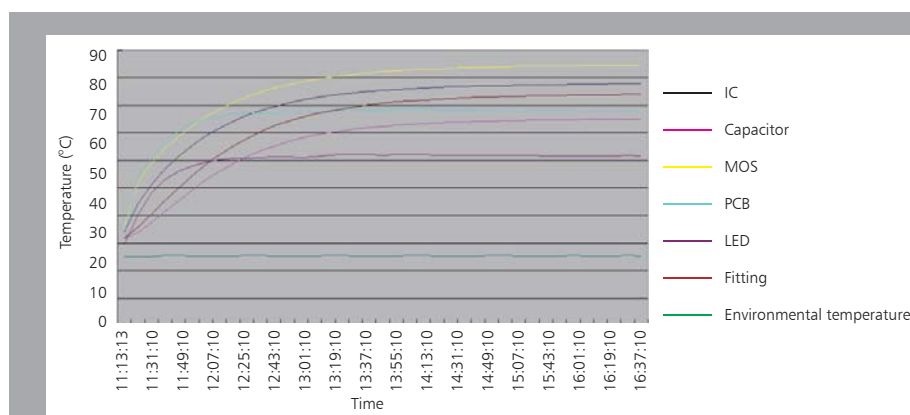

The driver lifespan is based on capacitor working temperature.

Installation

SPEC.	A ± 10
600mm	300mm
900mm	600mm
1200mm	900mm

1. Fix the holders of suspending ropes and surface mounted frame on the ceiling.

2. Fix the pedestal of suspending ropes on the lamp by screws.

3. Fix the suspending wires on the base.

4. Connect wire mains cable into quick terminal block.

5. Put the surface mounted frame into the screw slot of installation fixture. Fix the screws, settle the input wires properly and switch on.

6. For this Suspended Linkable type, the distance between the holders of suspending ropes of the connected two lamps should around 145 ± 10 mm.

7. Remove the safety cover on the both sides of the batten by screwdriver.

8. Lock the linkable bracket into end cap slots, and insert connector into lamp slots.

9. Link the two lamps together, fix the 2pcs screws on the linkable bracket and connect the power.

Packaging Information

	SIZE(CM)	N.W/pc (KGS)	G.W.(KGS)	Q'TY(PCs)
Carton	93.5*30.5*24	1.25	17.6	12

	CTNS	Q'TY(PCs)	VOLUME(CBM)
20" standard container	400	4800	28
40" standard container	800	9600	56

