



Commercial Office Lighting Case

www.upshine.com





Office Room Lighting Case

Application Show

Product Recommended

Installation Notes



Commercial-Office-14 PL30120-45W AU



Commercial-Office-8 AL06-36W-B AU



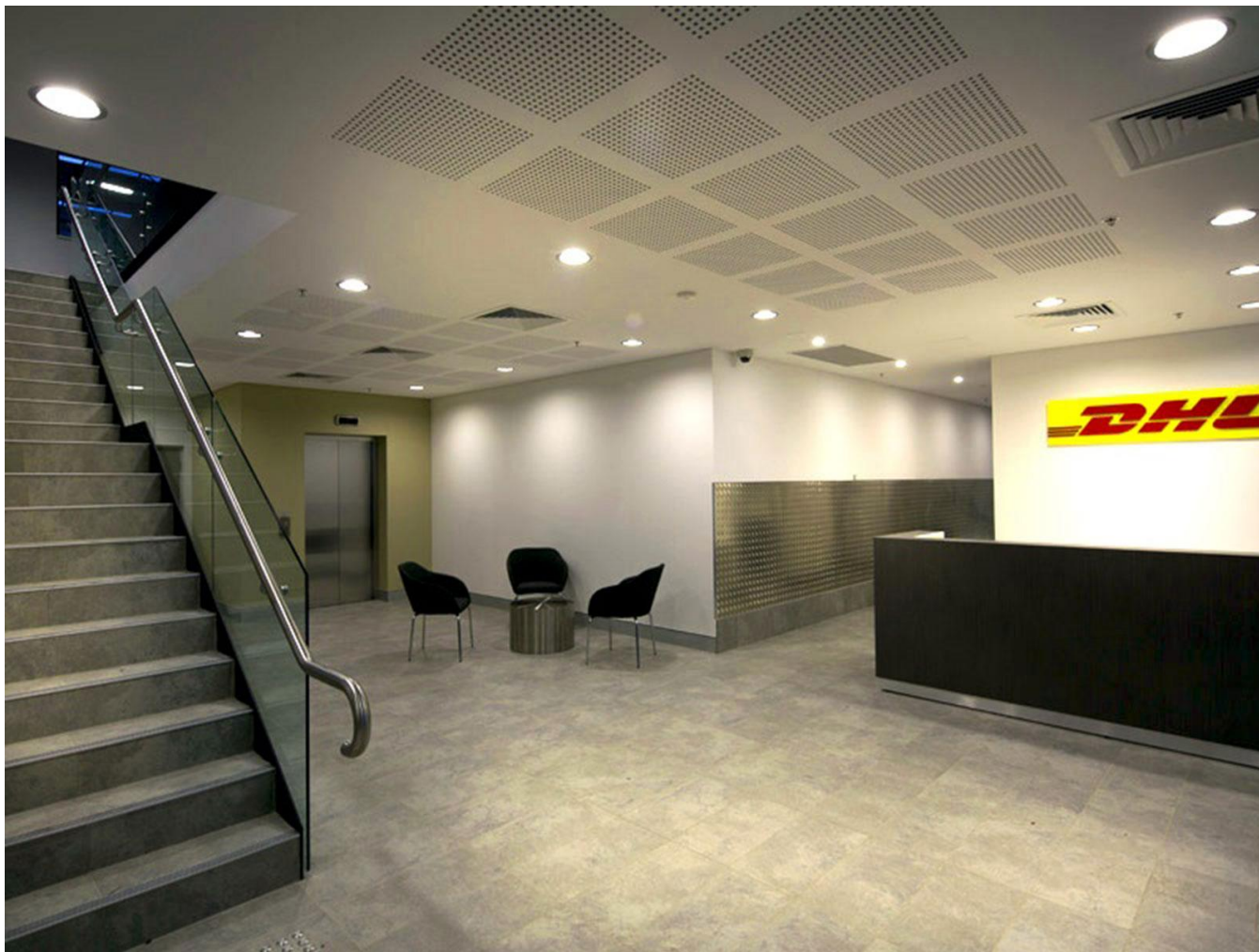

Commercial-Office-2 CL59-8-25W black AU



UPSHINE LED office lighting adopts high lumen and high CRI >80. The ultra slim profile fits seamlessly into any work place, High quality and energy-saving



Installation Information

PL-U LED Panel Light Installation

1. Recessed into ceiling

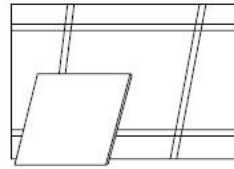

1. Remove ceiling plaster slab

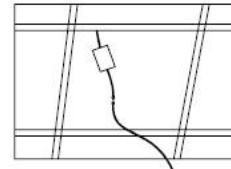

2. Connect power supply

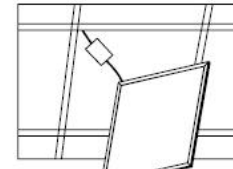

3. Fix the panel light into right place

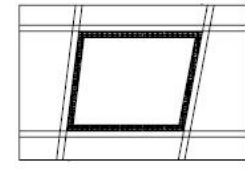

4. Stabilize the panel

2. Suspending



1. A. Fix the anchor into target place on the ceiling
B. Fix the installation mount on the ceiling with plastic anchor

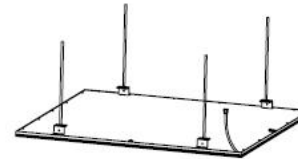

2. Hang the panel to ceiling with suspended installation kits

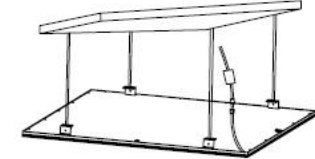

3. Adjust the length of steel wire. Connect the power supply

3. Surface mounted



↑ 1. Fix the frame on the ceiling with screw

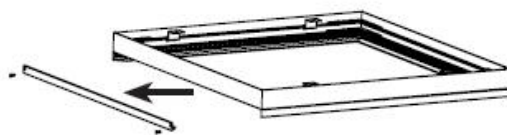

2. Pull down the side frame

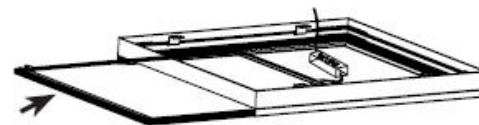

3. Push the panel into the frame, connect the driver

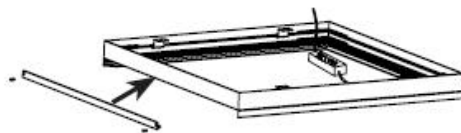

4. Install the side frame

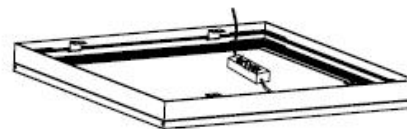

5. Turn on the power switch, finish the installation

AL17 LED Batten Installation

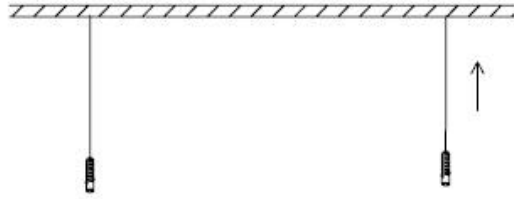

Step 1. Knock-in the plastic anchor into ceiling



Step 2. Fastening the clips on the ceiling

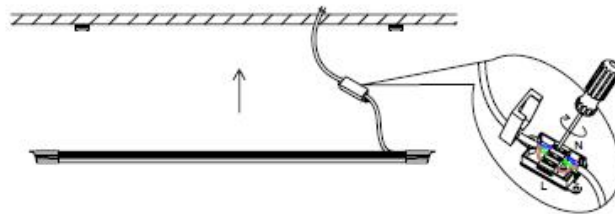

-  L - SWITCHED
-  E - EARTH
-  N - NEUTRAL

Step 3. Connect the power supply and hang the fixture back to the clips

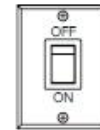

Step 4. Restore power supply, switch on and test for correct operation

CL59 LED Downlight Installation

Ceiling Opening $\text{Ø}70\text{-}75\text{mm}$

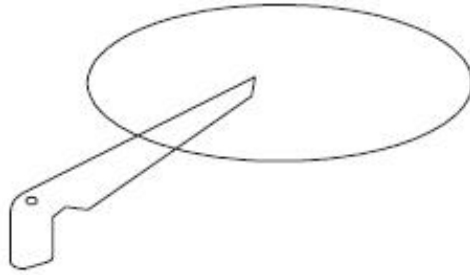

1

Connect Power supply

Spring Clips

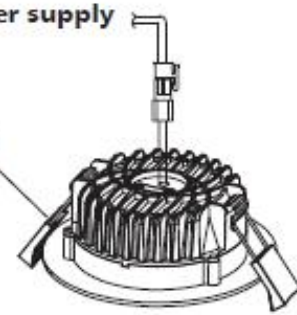

2

A. Hold back spring clips

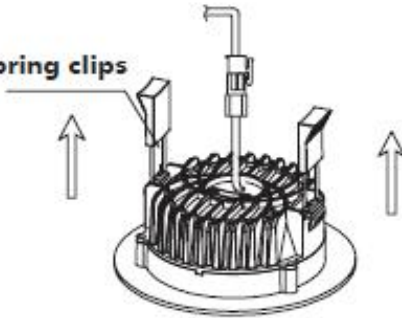

B. Push downlight into position

3

Spring Clips

Finish

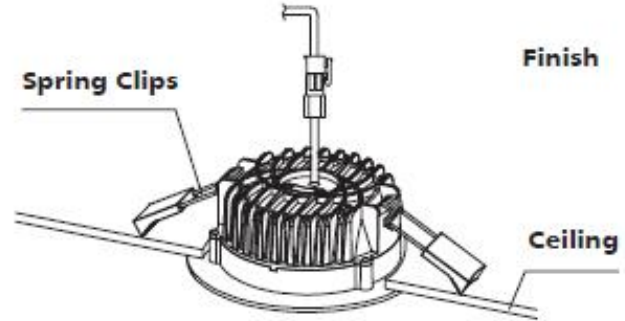

4



Thank You

