

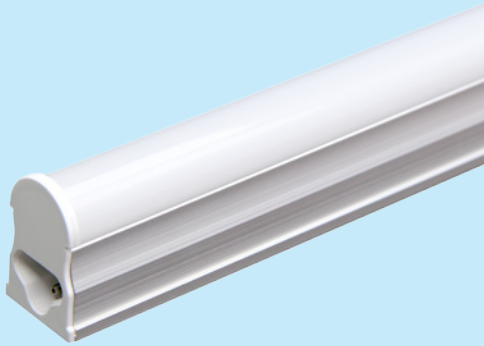

Technical Application Guide for UP-SHINE LED Tube Light

UP-T512W900-D

Introduction



Up-shine LED tube T5 is designed with integrated structure, using 2835SMD LED as light source, CRI>80. V0 fire-rated full PC cover ensures high light transmittance and safe installation. With Built-in driver in light fixture, our T5 tubes achieve high lighting performance and good heat dissipation.

- Up to 70% energy saving compared to traditional tube
- Long lifetime of 40,000 hours
- 120° wide beam angle
- 900mm length
- CCT: 3000K 4000K 5000K 5700K
- No UV/IR light
- Environment friendly, without Mercury or any other hazardous substances

Application notes

- IP20 for indoor use only
- Professional electrician for installation only
- Switch off before installation
- Do not touch when in use
- Keep away from hot steam and corrosive gas

Application Areas

Suitable for commercial and residential applications like office, supermarket, shop, school, hotel, restaurant, workshop, warehouse, home etc.

Certificates

CE **RoHS**

Product Information

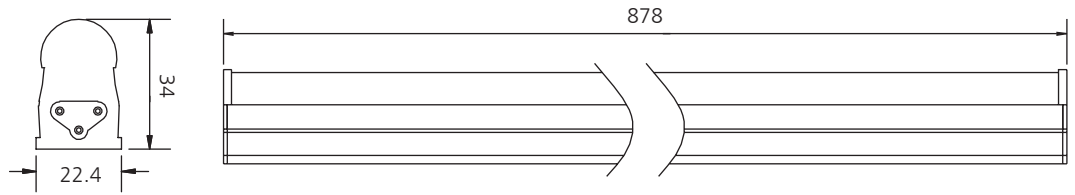

Technical Specifications

Model	Voltage	Power	Power Factor	Lumen (±5%)	Beam angle	CCT	Lifespan	CRI	Dimmable	Dimension
UP-T512W900-D	AC100-240V	12W	≥0.9	960	120°	3000K	40000h	≥80	No	L878*W22.4*H34mm
UP-T512W900-D	AC100-240V	12W	≥0.9	1000	120°	4000K	40000h	≥80	No	L878*W22.4*H34mm
UP-T512W900-D	AC100-240V	12W	≥0.9	1020	120°	5000K	40000h	≥80	No	L878*W22.4*H34mm
UP-T512W900-D	AC100-240V	12W	≥0.9	1040	120°	5700K	40000h	≥80	No	L878*W22.4*H34mm

Driver data Sheet

Driver data	Non-dim
Input rated Voltage	AC100-240V
Frequency	50/60Hz
Input Voltage	AC85-265V
Efficiency	≥90%
Total load Wattage	12W±1W
Power Factor	≥0.9
Rated input current	≤0.14A
Full load output Voltage	DC70-80V
Rated output current	150mA
Output current range	150mA±5%
Power tolerance	±5%
Current output tolerance	±5%
Short circuit protection	PASS
Over voltage protection	PASS
Over temperature protection	PASS
Withstand voltage	AC1500V

Fixture Compatibility

Rated Wattage	Electrical Classification	Ingress Protection	Operating Temp	Operating Humidity	Storage Temp
12W	I	IP20	-20°C~45°C	0~90%	-20°C~65°C

Spectral Distribution

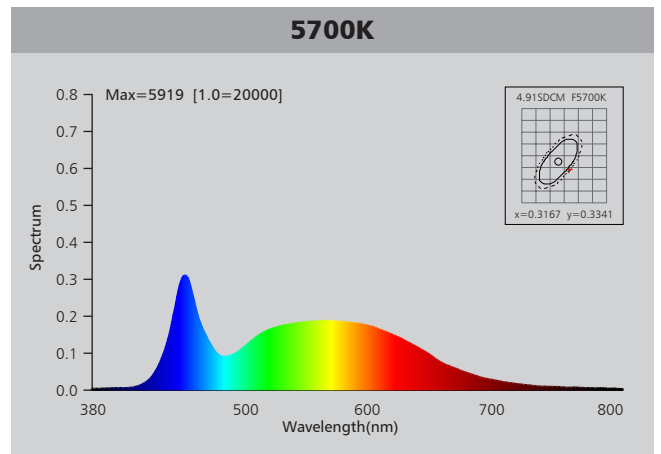
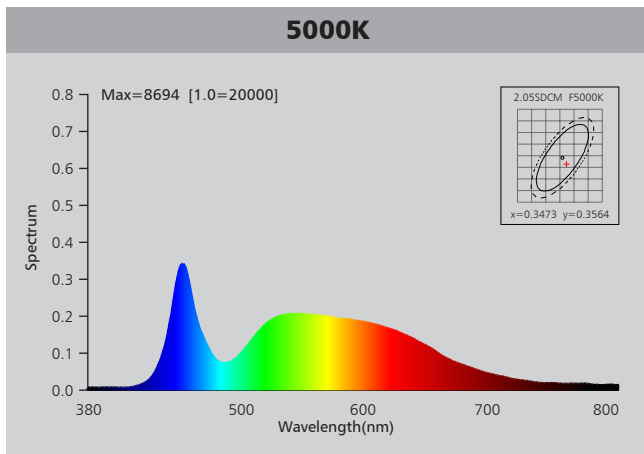
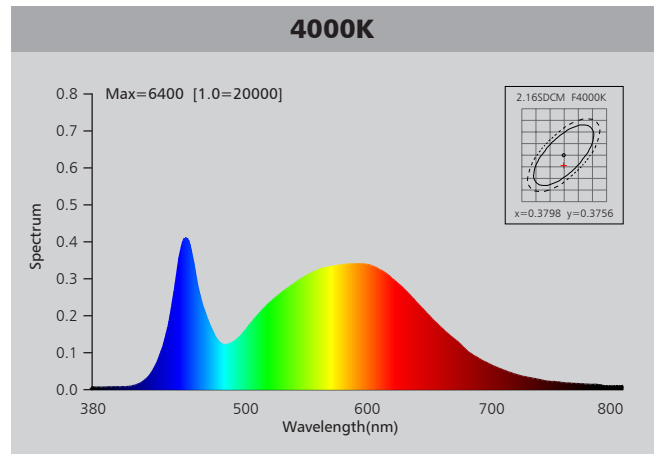
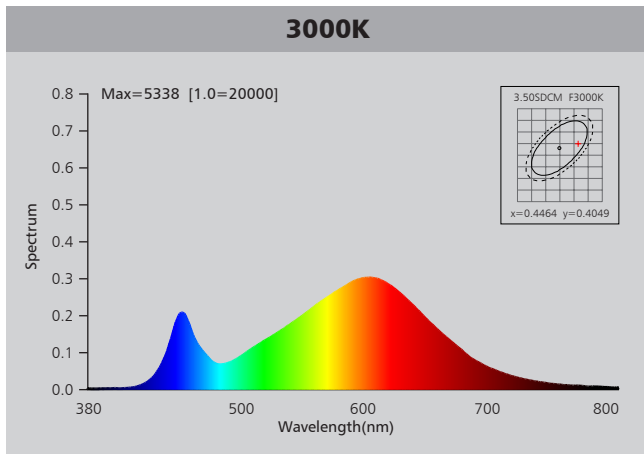

Photometric Diagram

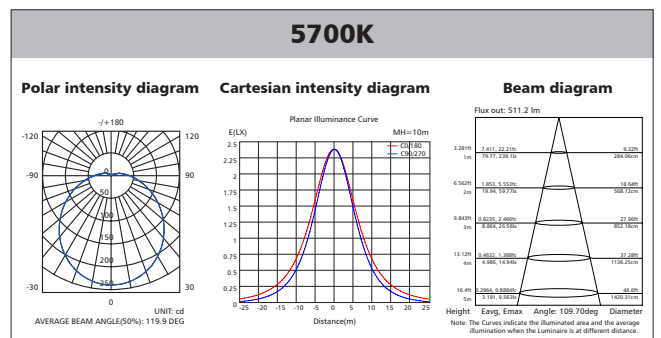
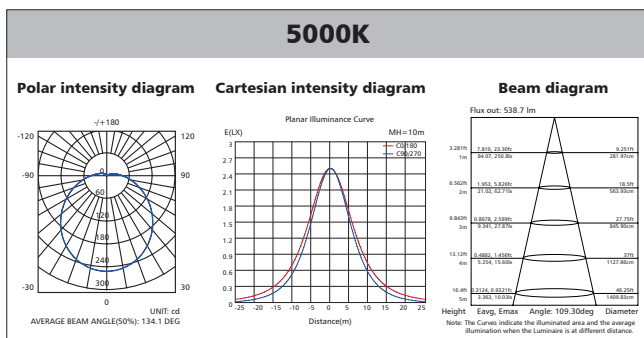
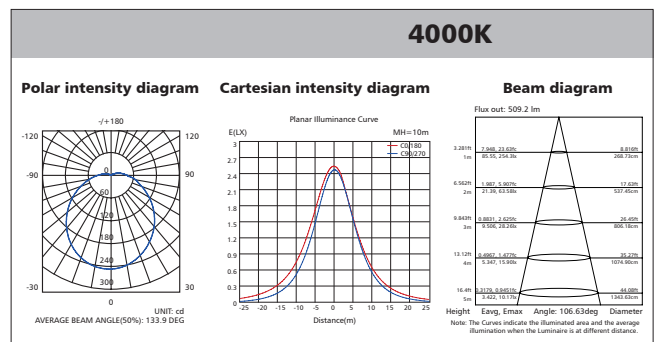
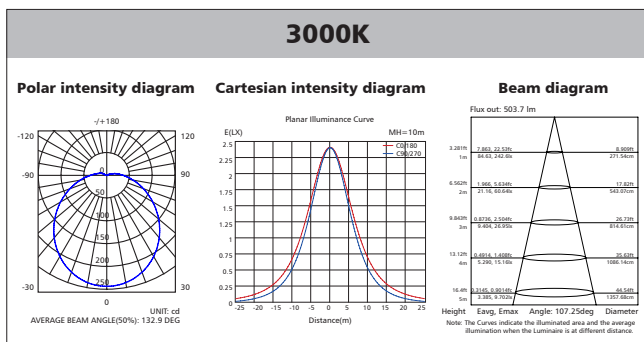

Polar Diagram Comparison

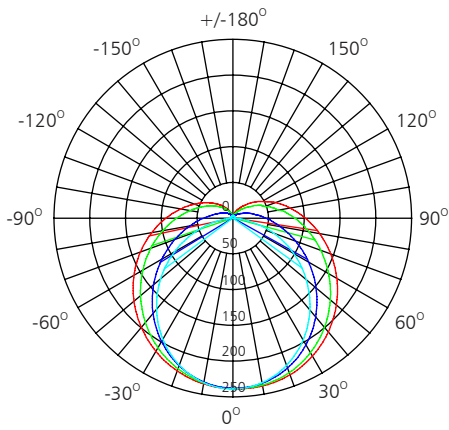

UNIT: cd

- C0/180, 159.8 deg
- C30/210, 146.4 deg
- C60/240, 119.9 deg
- C90/270, 107.7 deg

AVERAGE BEAM ANGLE (50%): 133.4DEG



Driver lifetime & LED light decay rate

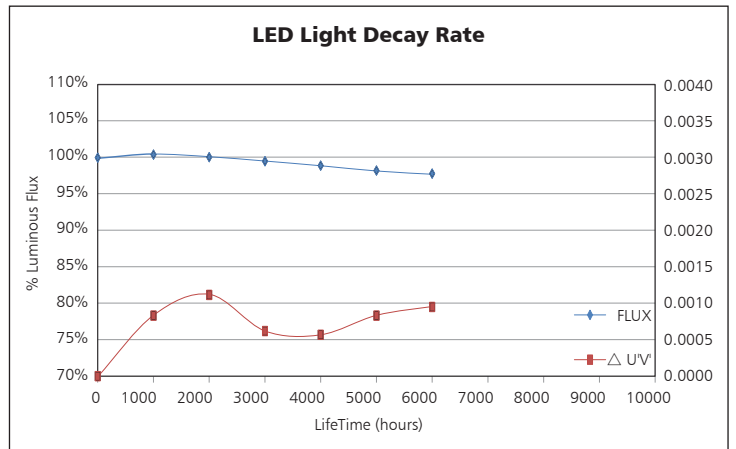
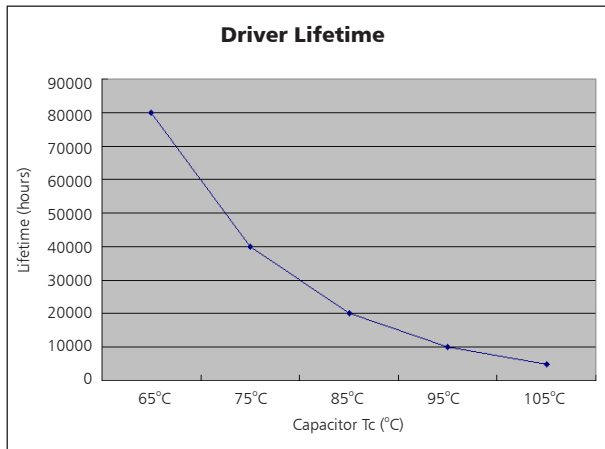

Temperature

- The testing is operated at 25°C
- The lifetime of capacitor, minimum of 5,000 hours if operated at 105°C, will be doubled whenever the temperature drops 10°C
- The highest withstand temperature of IC, MOS could be 120°C
- The highest withstand temperature of LED junction temperature is 150°C

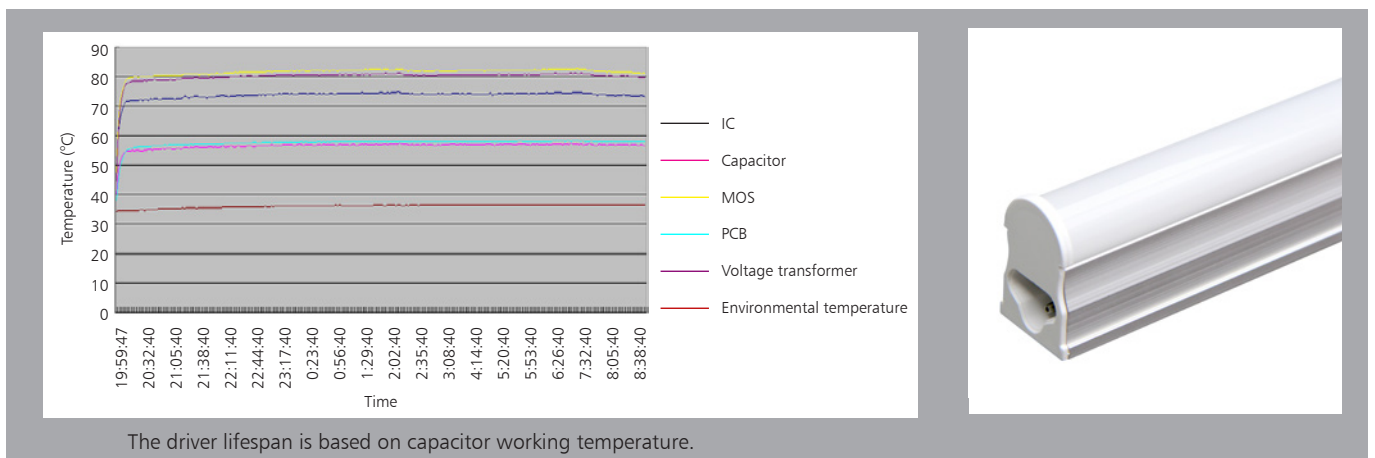

Installation

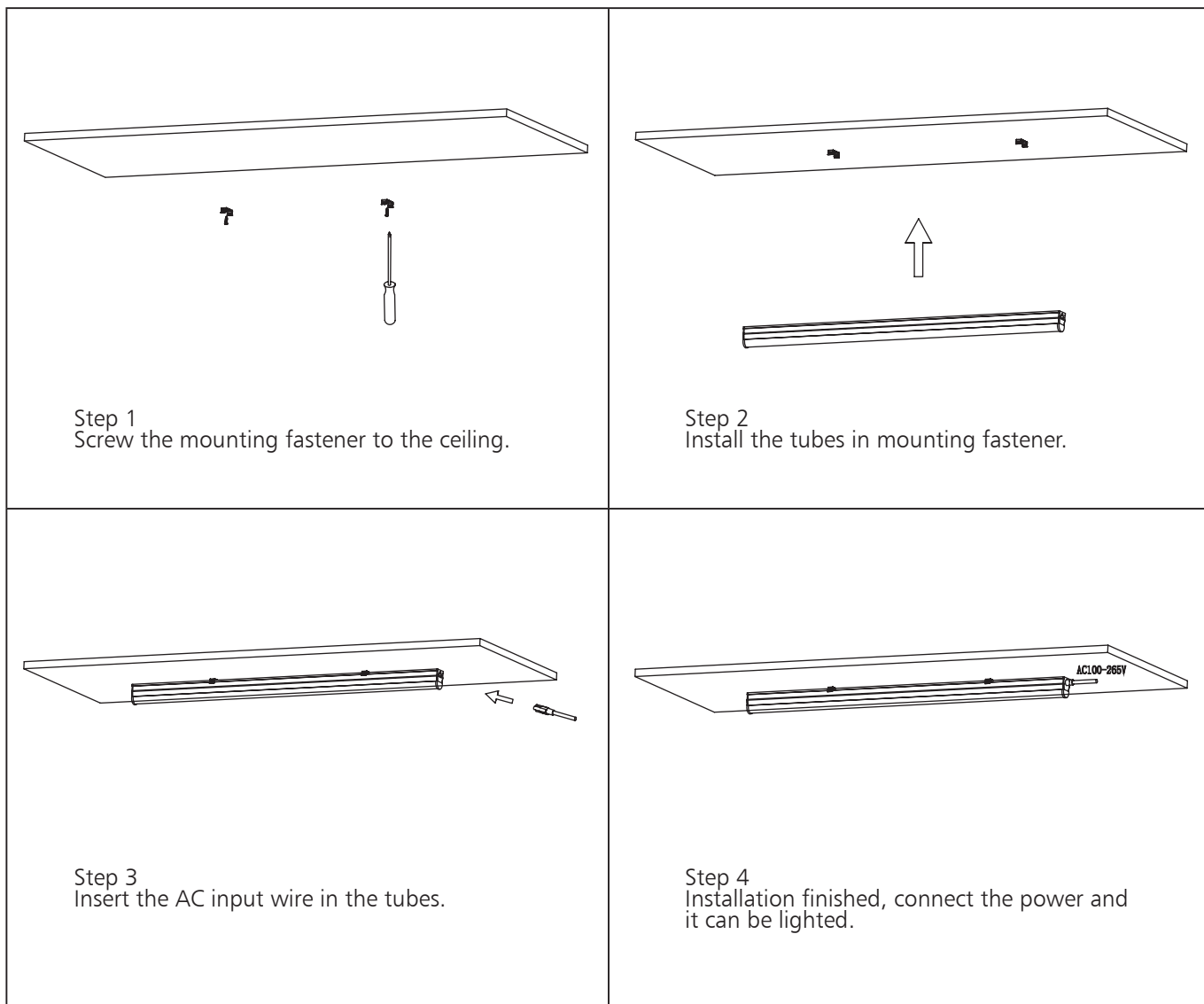

Packaging Information

	SIZE(CM)	N.W/pc (KGS)	G.W.(KGS)	Q'TY(PCS)
Carton	98*24*16.5	0.34	10.75	25

	CTNS	Q'TY(PCS)	VOLUME(CBM)
20" standard container	700	17500	28
40" standard container	1400	35000	56

