

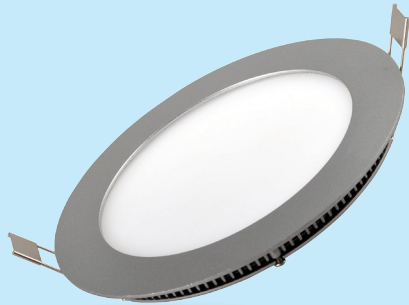

# Technical Application Guide for UP-SHINE LED Panel Light

UP-PL2419-20W

# Introduction



Super Slim round panel provided in full diameter, adopting SMD led chip. External driver comes with triac dim, it shares great popularity by perfect dimming range and great compatibility with worldwide dimmers. The ultra slim profile fits perfectly for all working places.

- Up to 80% energy saving compared to standard CFL
- Long lifetime of 40,000 hours
- Triac dim
- 120° wide beam angle
- 230mm cutout
- CCT: 3000K 4000K  
5000K 5700K
- No UV/IR light
- Environment friendly, without Mercury or any other hazardous substances

## Application notes

- IP40 for indoor use only
- Professional electrician for installation only
- Switch off before installation
- Do not touch when in use
- Keep away from hot steam and corrosive gas

## Application Areas

Widely used for various commercial lighting and residential lighting applications, such as offices, shopping mall, hotel, restaurant, hospital, home lighting etc.

## Certificates

CE RoHS



# Product Information

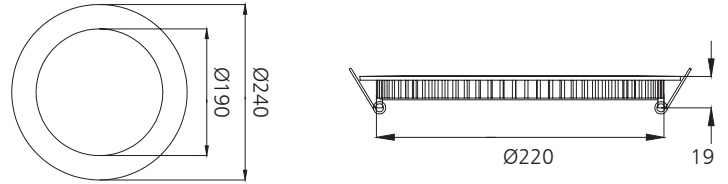

## Technical Specifications

| Model           | Voltage | Power | Power Factor | Lumen (±5%) | Beam angle | CCT   | Lifespan | CRI | Dimmable | Dimension              |
|-----------------|---------|-------|--------------|-------------|------------|-------|----------|-----|----------|------------------------|
| UP-PL2419-20W   | AC230V  | 20W   | ≥0.9         | 1190        | 120°       | 3000K | 40000h   | ≥80 | No       | Ø240*19mm cutout 230mm |
| UP-PL2419-20W   | AC230V  | 20W   | ≥0.9         | 1260        | 120°       | 4000K | 40000h   | ≥80 | No       | Ø240*19mm cutout 230mm |
| UP-PL2419-20W   | AC230V  | 20W   | ≥0.9         | 1340        | 120°       | 5000K | 40000h   | ≥80 | No       | Ø240*19mm cutout 230mm |
| UP-PL2419-20W   | AC230V  | 20W   | ≥0.9         | 1460        | 120°       | 5700K | 40000h   | ≥80 | No       | Ø240*19mm cutout 230mm |
| UP-PL2419-20W-D | AC230V  | 20W   | ≥0.9         | 1060        | 120°       | 3000K | 40000h   | ≥80 | Yes      | Ø240*19mm cutout 230mm |
| UP-PL2419-20W-D | AC230V  | 20W   | ≥0.9         | 1140        | 120°       | 4000K | 40000h   | ≥80 | Yes      | Ø240*19mm cutout 230mm |
| UP-PL2419-20W-D | AC230V  | 20W   | ≥0.9         | 1220        | 120°       | 5000K | 40000h   | ≥80 | Yes      | Ø240*19mm cutout 230mm |
| UP-PL2419-20W-D | AC230V  | 20W   | ≥0.9         | 1320        | 120°       | 5700K | 40000h   | ≥80 | Yes      | Ø240*19mm cutout 230mm |

## Driver data Sheet

| Driver data                 | DIM           | Non-dim    |
|-----------------------------|---------------|------------|
| Input rated Voltage         | AC230V        | AC230V     |
| Frequency                   | 50HZ          | 50HZ       |
| Input Voltage               | AC200-240V    | AC200-240V |
| Efficiency                  | ≥80%          | ≥85%       |
| Total load Wattage          | 20W±5%        | 20W±5%     |
| Power Factor                | ≥0.9          | ≥0.9       |
| Rated input current         | ≤0.12A        | ≤0.12A     |
| Full load output Voltage    | DC29-33V      | DC29-33V   |
| Rated output current        | 500mA         | 560mA      |
| Output current range        | 500mA±5%      | 560mA±5%   |
| Power tolerance             | ±5%           | ±5%        |
| Current output tolerance    | ±5%           | ±5%        |
| Dimming range               | 8%-100%       | —          |
| Dimmer                      | Triac dimmers | —          |
| Short circuit protection    | PASS          | PASS       |
| Over voltage protection     | PASS          | PASS       |
| Over temperature protection | PASS          | PASS       |
| Withstand voltage           | AC3750V       | AC3750V    |

## Fixture Compatibility

| Rated Wattage | Electrical Classification | Ingress Protection | Operating Temp | Operating Humidity | Storage Temp |
|---------------|---------------------------|--------------------|----------------|--------------------|--------------|
| 20W           | II                        | IP40               | -20°C~45°C     | 0~90%              | -20°C~65°C   |

# Spectral Distribution

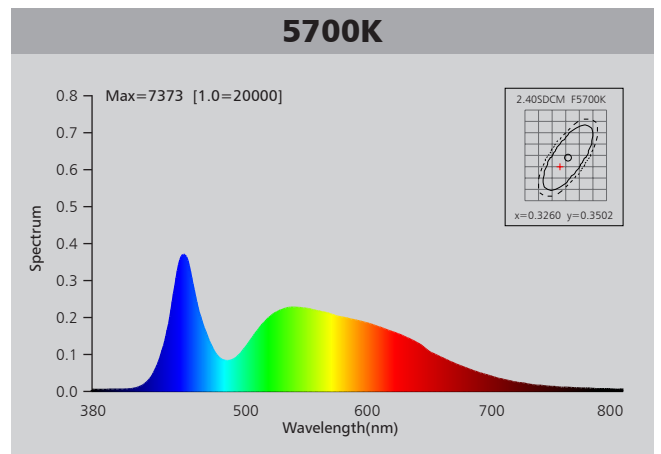
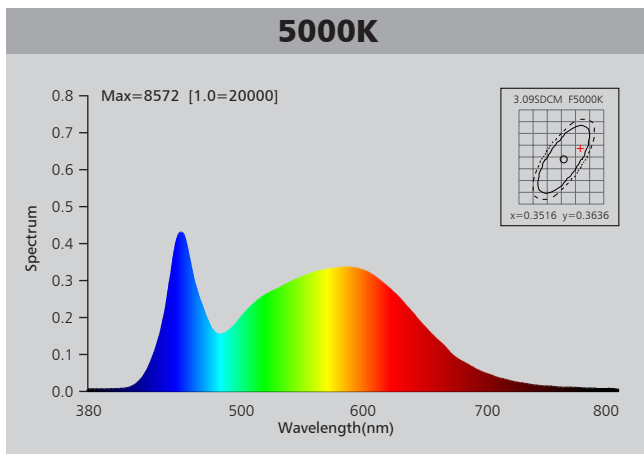
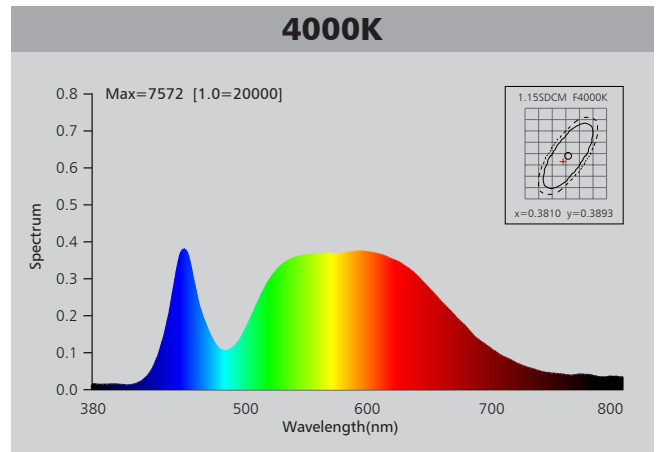
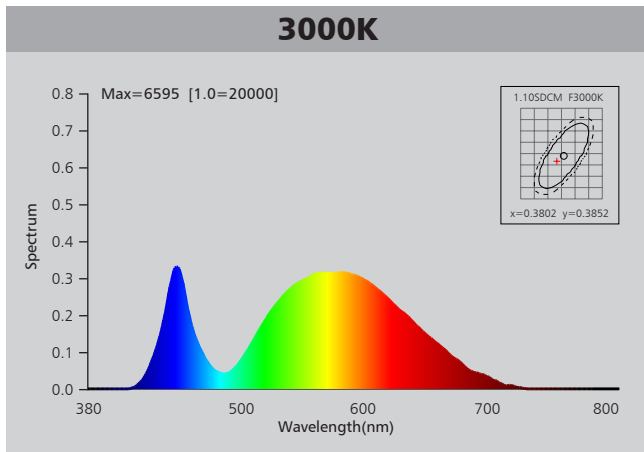

# Photometric Diagram

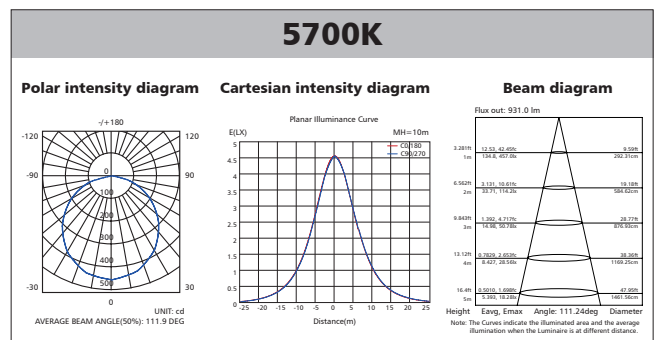
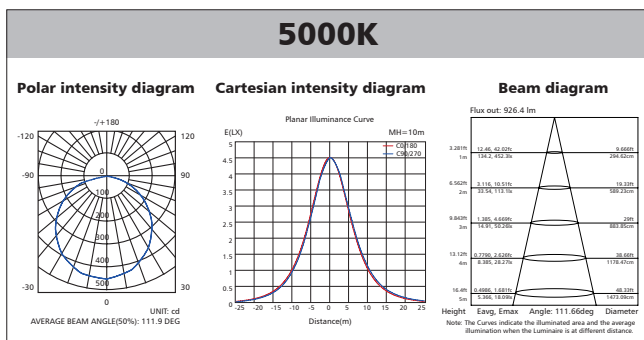
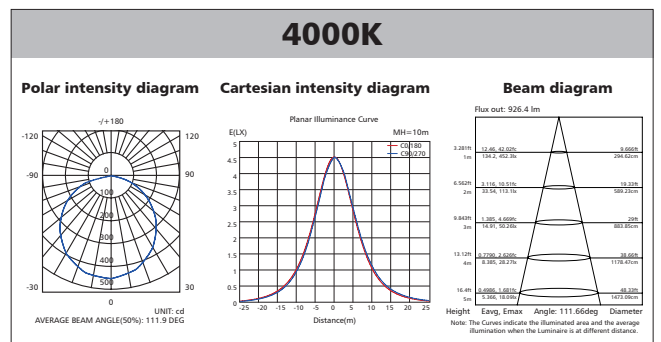
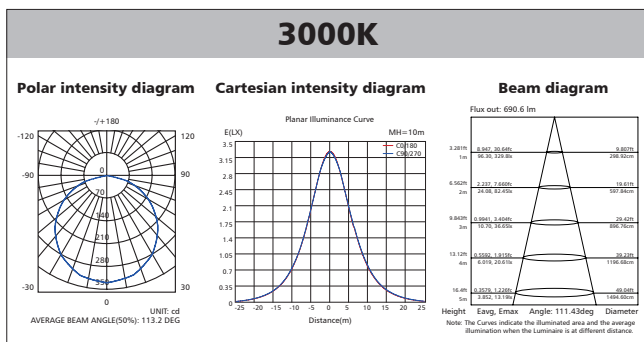

# Polar Diagram Comparison

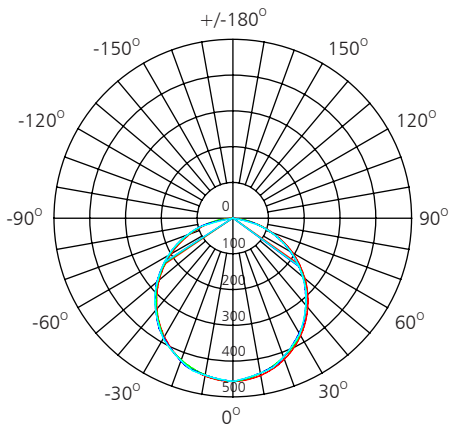

UNIT: cd

- C0/180, 111.2 deg
- C30/210, 110.9 deg
- C60/240, 111.9 deg
- C90/270, 111.3 deg

AVERAGE BEAM ANGLE (50%): 111.1DEG



# Driver lifetime & LED light decay rate

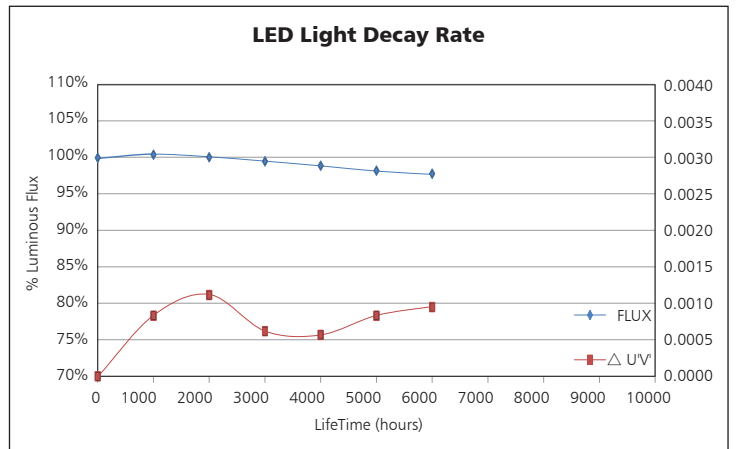
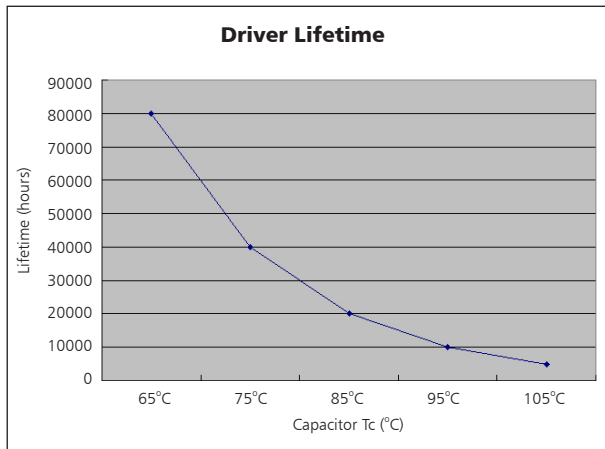

# Temperature

- The testing is operated at 25°C
- The lifetime of capacitor, minimum of 5,000 hours if operated at 105°C, will be doubled whenever the temperature drops 10°C
- The highest withstand temperature of IC, MOS could be 120°C
- The highest withstand temperature of LED junction temperature is 150°C

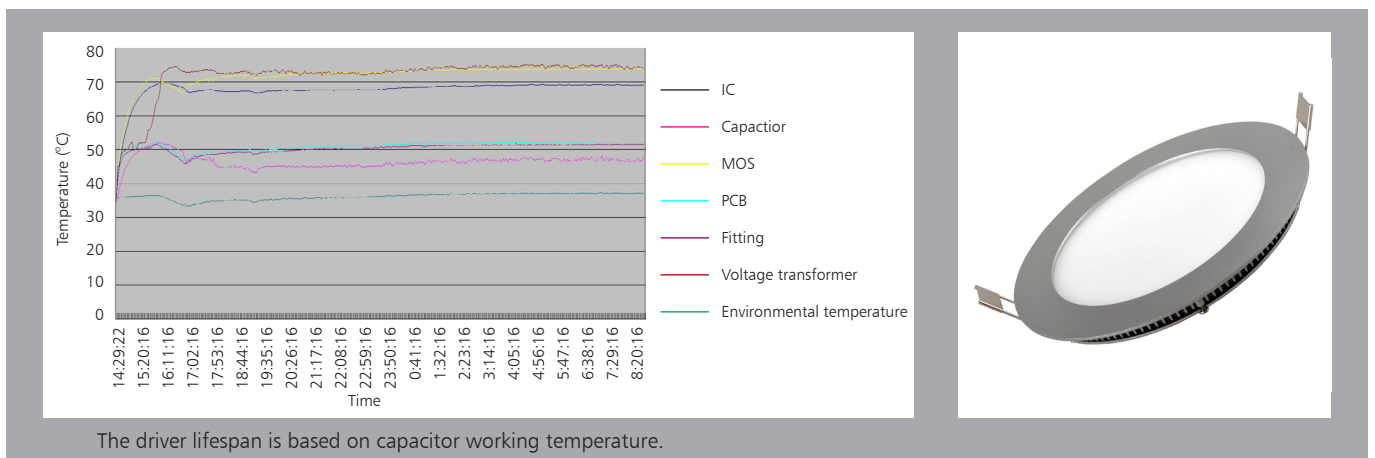

The driver lifespan is based on capacitor working temperature.

# Installation

| Install requirements            |      |
|---------------------------------|------|
| A-gap above the fitting         | 25mm |
| B-gap to the building material  | 25mm |
| C-gap to the thermal insulation | 25mm |

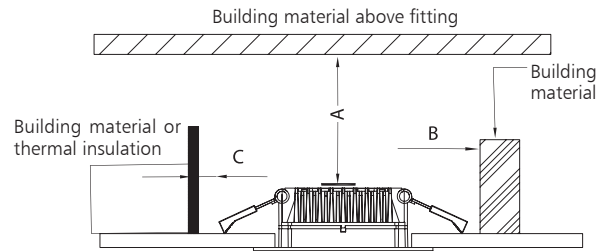

|  |  |
|--|--|
| <p><b>Ceiling opening Ø230mm</b></p> <p style="text-align: right;">1</p>   | <p><b>Connect Power supply</b></p> <p style="text-align: right;">2</p> |
| <p><b>A. Hold back spring clips</b><br/><b>B. Push downlight into position</b></p> <p style="text-align: right;">3</p> | <p><b>Finish</b></p> <p style="text-align: right;">4</p>               |

# Packaging Information

|        | SIZE(CM)     | N.W/pc (KGS) | G.W.(KGS) | Q'TY(PCS) |
|--------|--------------|--------------|-----------|-----------|
| Carton | 52.5*37*29.5 | 0.75         | 9.7       | 10        |

|                        | CTNS | Q'TY(PCS) | VOLUME(CBM) |
|------------------------|------|-----------|-------------|
| 20" standard container | 480  | 4800      | 28          |
| 40" standard container | 965  | 9650      | 56          |

