



Technical Application Guide for UP-SHINE LED Panel Light

UP-PL1219-7W

Introduction



Super Slim round panel provided in full diameter, adopting SMD led chip. External driver comes with triac dim, it shares great popularity by perfect dimming range and great compatibility with worldwide dimmers. The ultra slim profile fits perfectly for all working places.

- Up to 80% energy saving compared to standard CFL
- Long lifetime of 40,000 hours
- Triac dim
- 120° wide beam angle
- 110mm cutout
- CCT: 3000K 4000K
5000K 5700K
- No UV/IR light
- Environment friendly, without Mercury or any other hazardous substances

Application notes

- IP20 for indoor use only
- Professional electrician for installation only
- Switch off before installation
- Do not touch when in use
- Keep away from hot steam and corrosive gas

Application Areas

Widely used for various commercial lighting and residential lighting applications, such as offices, shopping mall, hotel, restaurant, hospital, home lighting etc.

Certificates

CE RoHS



Product Information

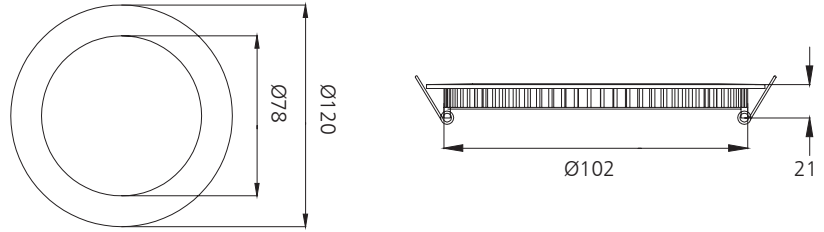

Technical Specifications

Model	Voltage	Power	Power Factor	Lumen (±5%)	Beam angle	CCT	Lifespan	CRI	Dimmable	Dimension
UP-PL1219-7W	AC230V	7W	≥0.9	450	120°	3000K	40000h	≥80	No	Ø120*21mm cutout 110mm
UP-PL1219-7W	AC230V	7W	≥0.9	470	120°	4000K	40000h	≥80	No	Ø120*21mm cutout 110mm
UP-PL1219-7W	AC230V	7W	≥0.9	510	120°	5000K	40000h	≥80	No	Ø120*21mm cutout 110mm
UP-PL1219-7W	AC230V	7W	≥0.9	530	120°	5700K	40000h	≥80	No	Ø120*21mm cutout 110mm
UP-PL1219-7W-D	AC230V	7W	≥0.9	410	120°	3000K	40000h	≥80	Yes	Ø120*21mm cutout 110mm
UP-PL1219-7W-D	AC230V	7W	≥0.9	450	120°	4000K	40000h	≥80	Yes	Ø120*21mm cutout 110mm
UP-PL1219-7W-D	AC230V	7W	≥0.9	470	120°	5000K	40000h	≥80	Yes	Ø120*21mm cutout 110mm
UP-PL1219-7W-D	AC230V	7W	≥0.9	480	120°	5700K	40000h	≥80	Yes	Ø120*21mm cutout 110mm

Driver data Sheet

Driver data	DIM	Non-dim
Input rated Voltage	AC230V	AC230V
Frequency	50HZ	50HZ
Input Voltage	AC200-240V	AC200-240V
Efficiency	≥75%	≥85%
Total load Wattage	7W±0.5W	7W±0.5W
Power Factor	≥0.9	≥0.9
Rated input current	≤0.042A	≤0.042A
Full load output Voltage	DC35-38V	DC35-38V
Rated output current	150mA	170mA
Output current range	150mA±5%	170mA±5%
Power tolerance	±5%	±5%
Current output tolerance	±5%	±5%
Dimming range	8%-100%	—
Dimmer	Triac dimmers	—
Short circuit protection	PASS	PASS
Over voltage protection	PASS	PASS
Over temperature protection	PASS	PASS
Withstand voltage	AC3750V	AC3750V

Fixture Compatibility

Rated Wattage	Electrical Classification	Ingress Protection	Operating Temp	Operating Humidity	Storage Temp
7W	II	IP20	-20°C~45°C	0~90%	-20°C~65°C

Spectral Distribution

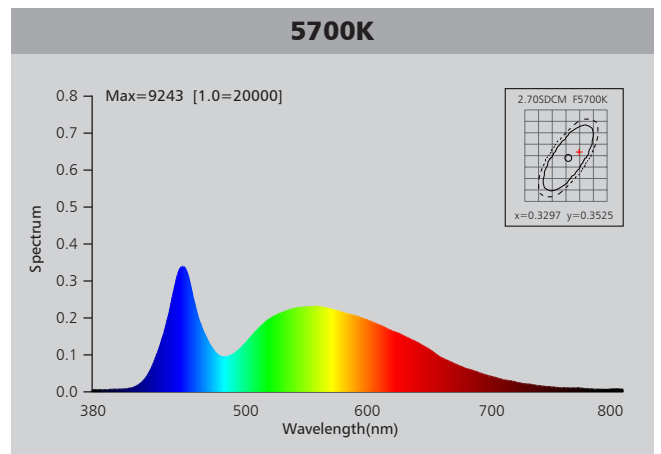
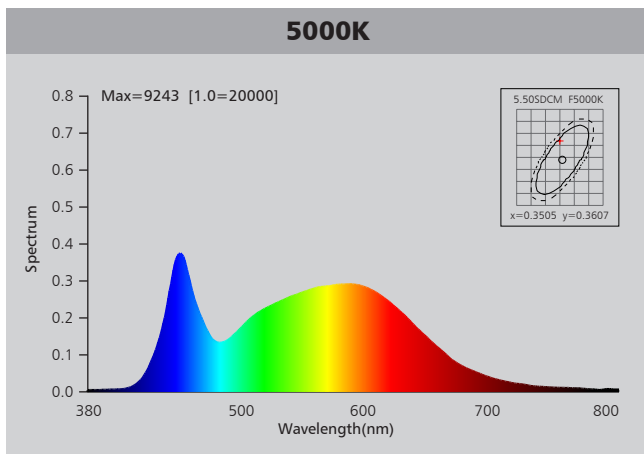
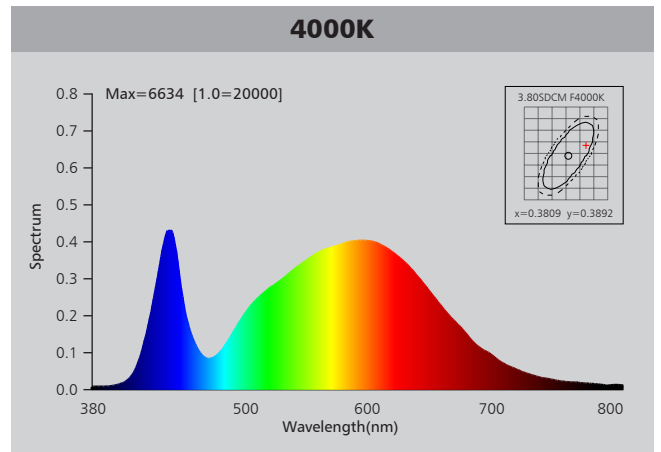
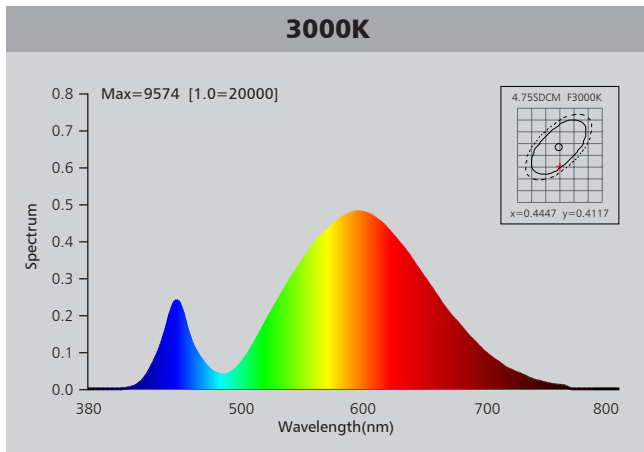

Photometric Diagram

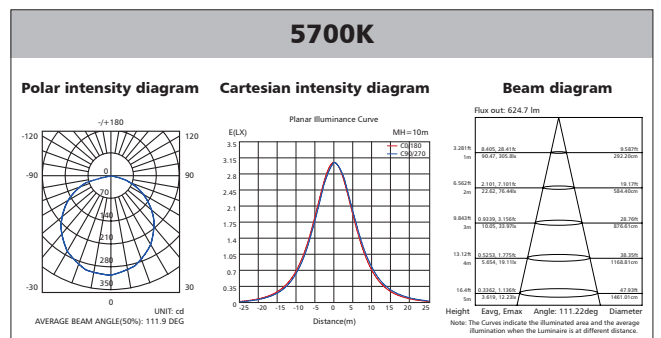
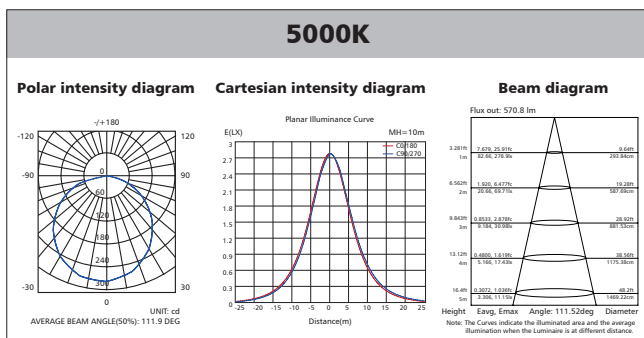
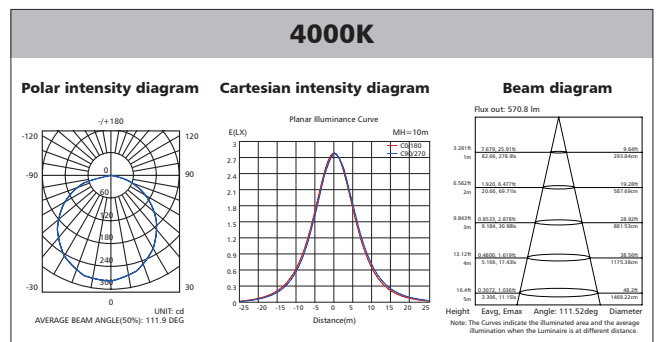
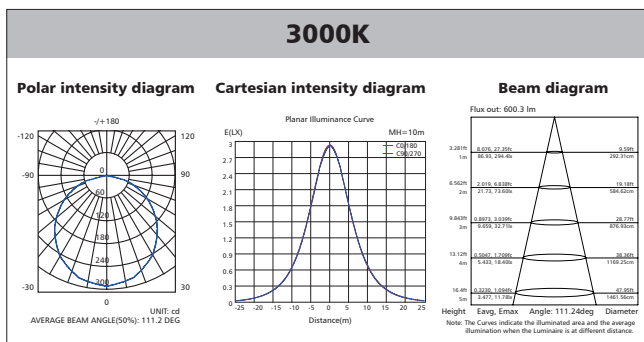

Polar Diagram Comparison

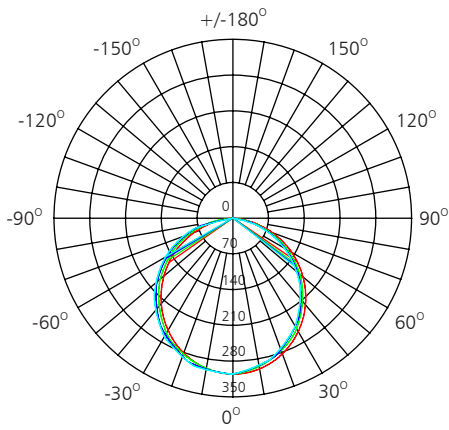

- UNIT: cd**
- C0/180, 111.2 deg
 - C30/210, 111.2 deg
 - C60/240, 111.9 deg
 - C90/270, 112.3 deg

AVERAGE BEAM ANGLE (50%): 111.6DEG



Driver lifetime & LED light decay rate

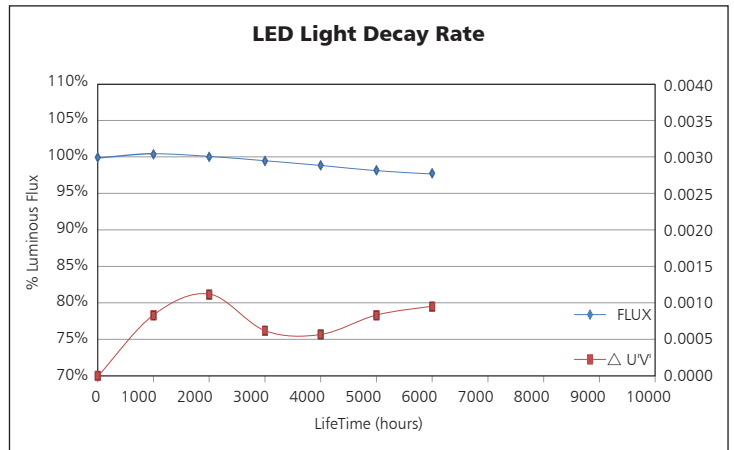
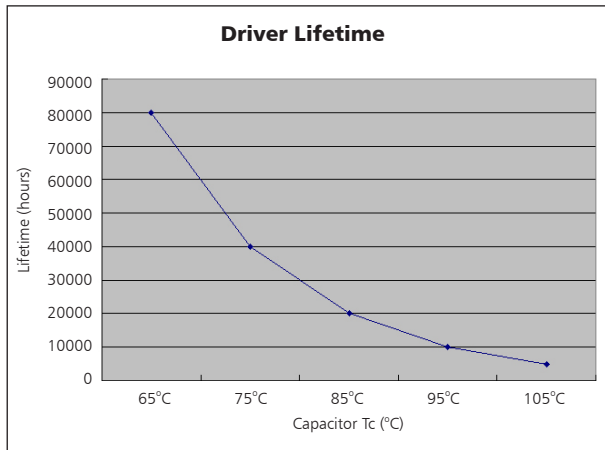

Temperature

- The testing is operated at 25°C
- The lifetime of capacitor, minimum of 5,000 hours if operated at 105°C, will be doubled whenever the temperature drops 10°C
- The highest withstand temperature of IC, MOS could be 120°C
- The highest withstand temperature of LED junction temperature is 150°C

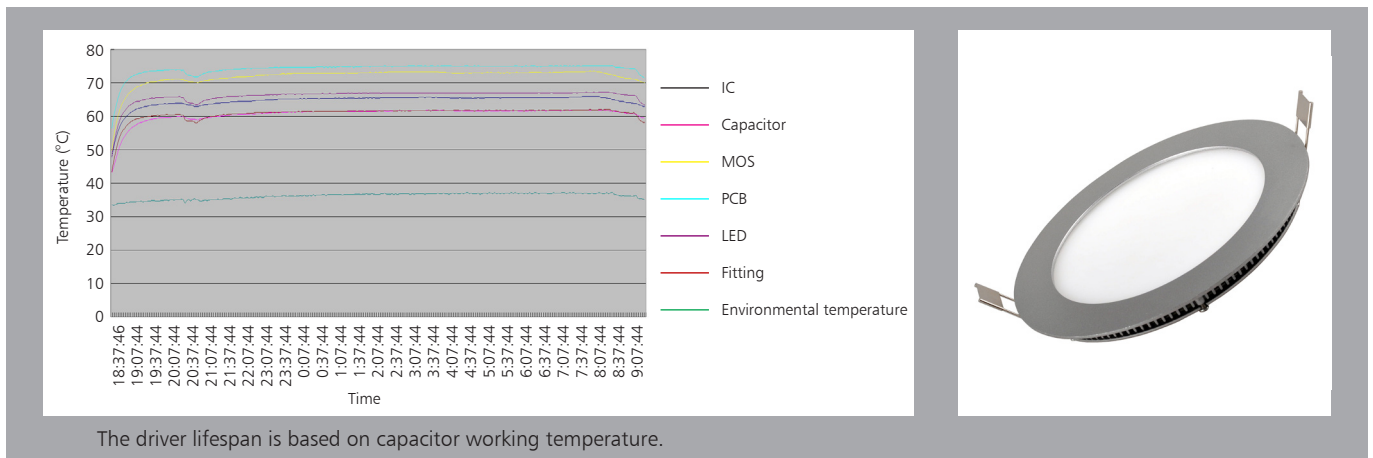

The driver lifespan is based on capacitor working temperature.

Installation

Install requirements	
A-gap above the fitting	25mm
B-gap to the building material	25mm
C-gap to the thermal insulation	25mm

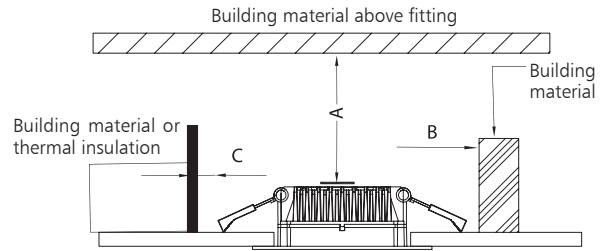

<p>Ceiling opening</p>	<p>Connect Power supply</p>
<p>A. Hold back spring clips B. Push round panel into position</p>	<p>Finish</p>

Packaging Information

	SIZE(CM)	N.W/pc (KGS)	G.W.(KGS)	Q'TY(PCS)
Carton	52.5*15*15.5	0.32	4.5	10

	CTNS	Q'TY(PCS)	VOLUME(CBM)
20" standard container	2120	21200	28
40" standard container	4240	42400	56

