



Technical Application Guide for UP-SHINE LED Panel Light

UP-PL30120-45W

Introduction



Up-shine led panel adopts high lumen SMD LED with CRI >80. The ultra slim profile fits seamlessly into any work place. It is available in various installation ways: embedded into ceiling, suspended with hanging wires, surface mounted in a concrete ceiling by using surface mounting frame.

- Up to 80% energy saving compared to standard CFL
- Long lifetime of 40,000 hours
- 120° wide beam angle
- CCT: 3000K 4000K
5000K 5700K
- No UV/IR light
- Environment friendly, without Mercury or any other hazardous substances

Application notes

- IP40 for indoor use only
- Professional electrician for installation only
- Switch off before installation
- Do not touch when in use
- Keep away from hot steam and corrosive gas

Application Areas

Office & school lighting: office room, meeting room, class room etc.

Commercial lighting: shopping mall, super market, retailer shops etc.

Other situations: hospital, laboratory, dust-free workshop etc.

Certificates



RoHS



Product Information

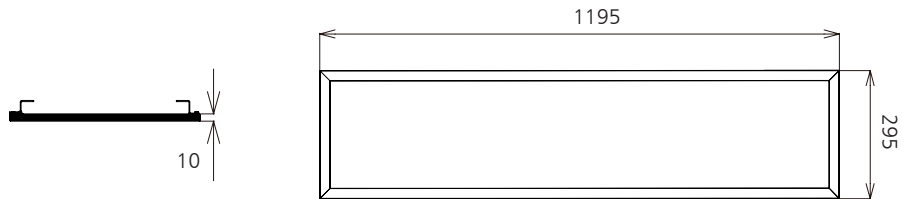

Technical Specifications

Model	Voltage	Power	Power Factor	Lumen (±5%)	Beam angle	CCT	Lifespan	CRI	Dimmable	Dimension
UP-PL30120-45W	AC100-240V	45W	≥0.9	3060	120°	3000K	40000h	≥80	No	1195*295*10mm
UP-PL30120-45W	AC100-240V	45W	≥0.9	3240	120°	4000K	40000h	≥80	No	1195*295*10mm
UP-PL30120-45W	AC100-240V	45W	≥0.9	3290	120°	5000K	40000h	≥80	No	1195*295*10mm
UP-PL30120-45W	AC100-240V	45W	≥0.9	3330	120°	5700K	40000h	≥80	No	1195*295*10mm

Driver data Sheet

Driver data	Non-dim
Input rated Voltage	AC100-240V
Frequency	50/60Hz
Input Voltage	AC85-265V
Efficiency	≥86%
Total load Wattage	45W±5%
Power Factor	≥0.9
Rated input current	≤0.5A
Full load output Voltage	DC35-38V
Rated output current	1050mA
Output current range	1050mA±5%
Power tolerance	±5%
Current output tolerance	±5%
Dimming range	—
Dimmer	—
Short circuit protection	PASS
Over voltage protection	PASS
Over temperature protection	PASS
Withstand voltage	AC3750V

Fixture Compatibility

Rated Wattage	Electrical Classification	Ingress Protection	Operating Temp	Operating Humidity	Storage Temp
45W	II	IP40	-20°C~45°C	0~90%	-20°C~65°C

Spectral Distribution

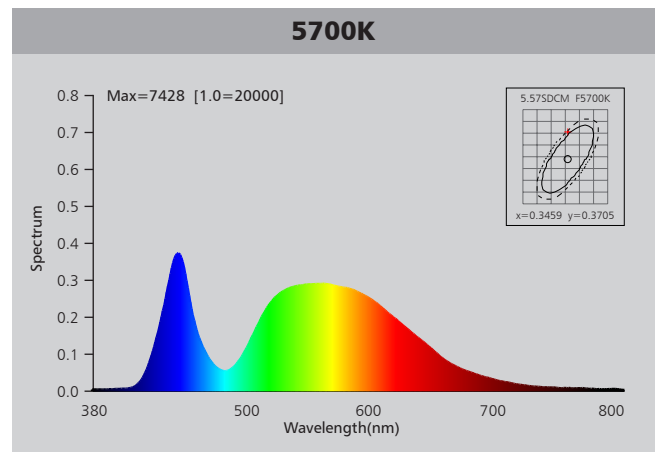
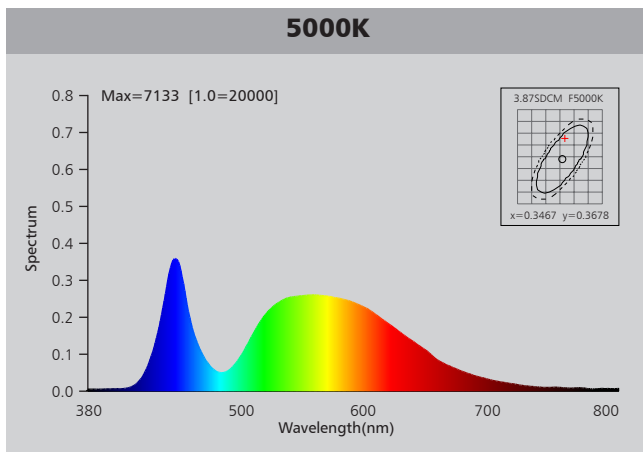
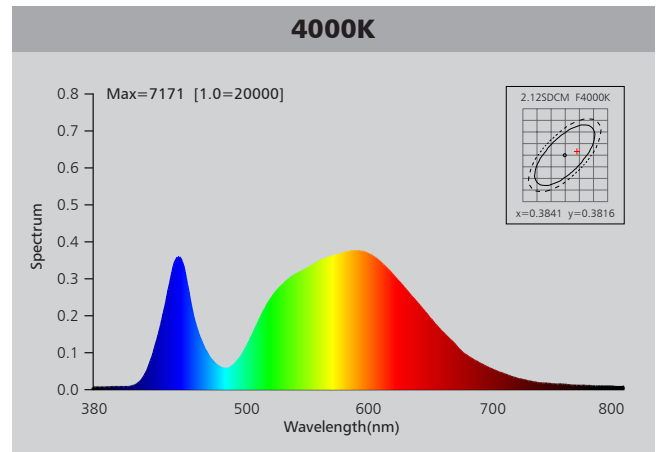
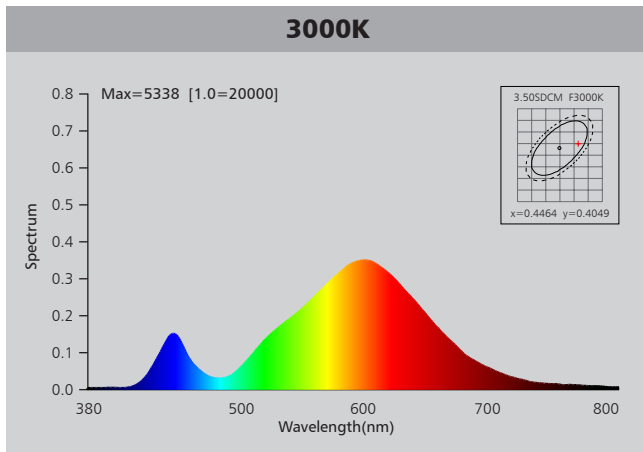

Photometric Diagram

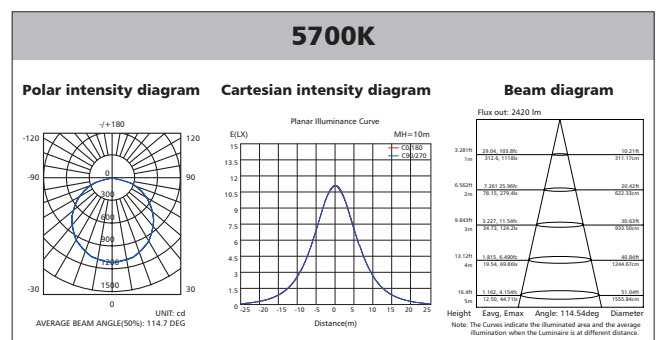
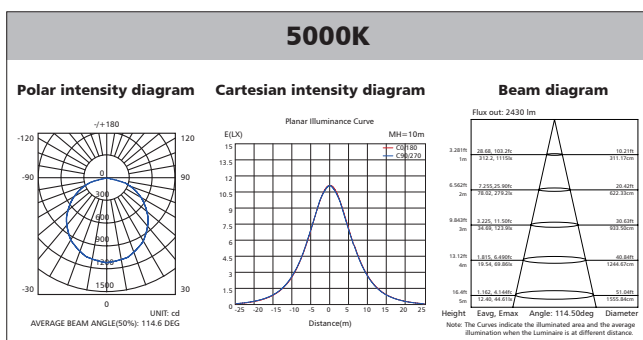
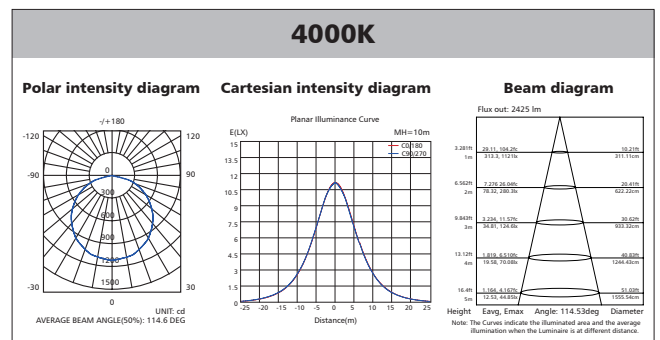
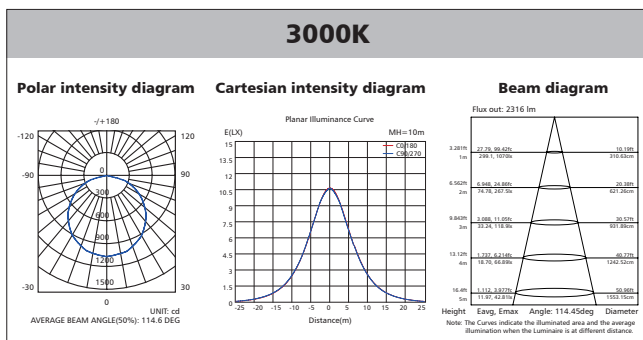

Polar Diagram Comparison

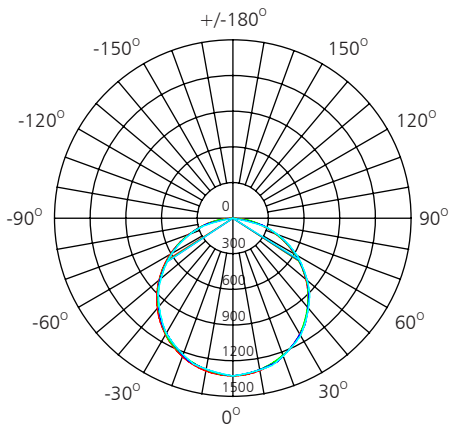

UNIT: cd

- C0/180, 114.5 deg
- C30/210, 114.0 deg
- C60/240, 114.1 deg
- C90/270, 114.4 deg

AVERAGE BEAM ANGLE (50%): 114.2DEG



Driver lifetime & LED light decay rate

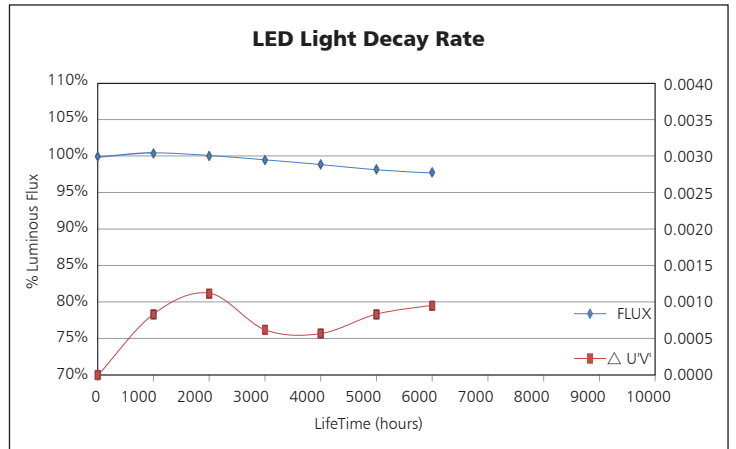
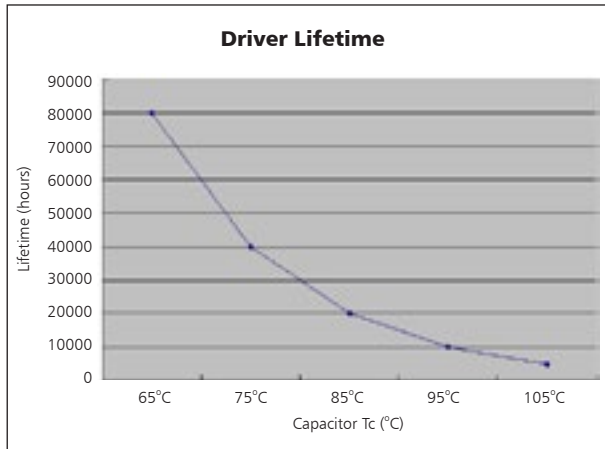

Temperature

- The testing is operated at 25°C
- The lifetime of capacitor, minimum of 5,000 hours if operated at 105°C, will be doubled whenever the temperature drops 10°C
- The highest withstand temperature of IC, MOS could be 120°C
- The highest withstand temperature of LED junction temperature is 150°C

Time	IC	Capacitor	MOS	PCB	Fitting	Voltage transformer	Environmental temperature
14:29:22	40	40	40	40	40	40	25
15:20:16	50	50	50	50	50	50	25
16:11:16	60	60	60	60	60	60	25
17:02:16	70	70	70	70	70	70	25
17:53:16	75	75	75	75	75	75	25
18:44:16	75	75	75	75	75	75	25
19:35:16	75	75	75	75	75	75	25
20:26:16	75	75	75	75	75	75	25
21:17:16	75	75	75	75	75	75	25
22:08:16	75	75	75	75	75	75	25
22:59:16	75	75	75	75	75	75	25
23:50:16	75	75	75	75	75	75	25
0:41:16	75	75	75	75	75	75	25
1:32:16	75	75	75	75	75	75	25
2:23:16	75	75	75	75	75	75	25
3:14:16	75	75	75	75	75	75	25
4:05:16	75	75	75	75	75	75	25
4:56:16	75	75	75	75	75	75	25
5:47:16	75	75	75	75	75	75	25
6:38:16	75	75	75	75	75	75	25
7:29:16	75	75	75	75	75	75	25
8:20:16	75	75	75	75	75	75	25

The driver lifespan is based on capacitor working temperature.

Installation

1. Recessed into ceiling

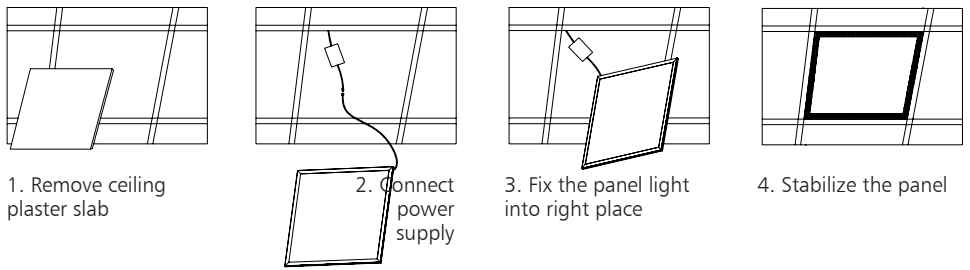

1. Remove ceiling plaster slab
2. Connect power supply
3. Fix the panel light into right place
4. Stabilize the panel

2. Suspending

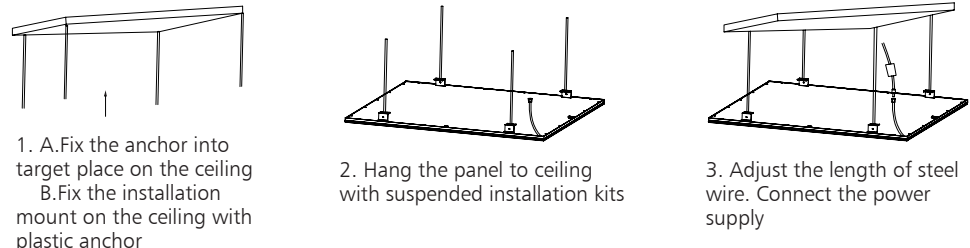

1. A. Fix the anchor into target place on the ceiling
B. Fix the installation mount on the ceiling with plastic anchor
2. Hang the panel to ceiling with suspended installation kits
3. Adjust the length of steel wire. Connect the power supply

3. Surface mounted

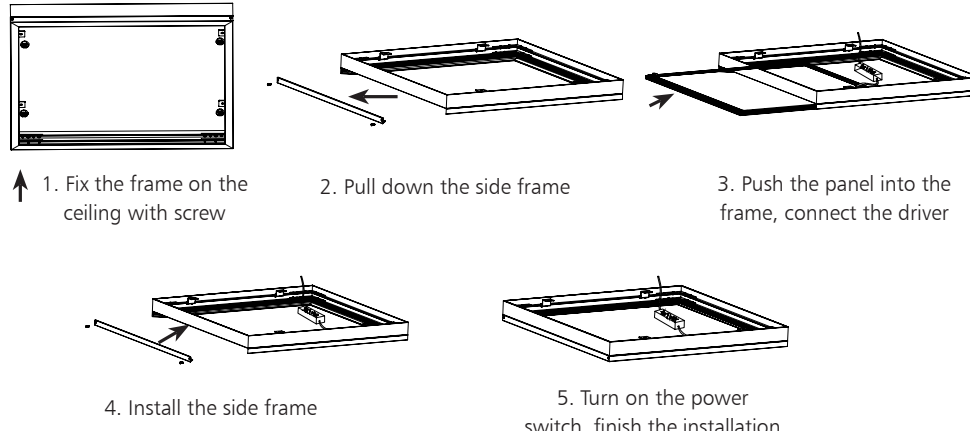

1. Fix the frame on the ceiling with screw
2. Pull down the side frame
3. Push the panel into the frame, connect the driver
4. Install the side frame
5. Turn on the power switch, finish the installation

Packaging Information

	SIZE(CM)	N.W/pc (KGS)	G.W.(KGS)	Q'TY(PCs)
Carton	133*34.5*39.5	4.2	27.5	5

	CTNS	Q'TY(PCs)	VOLUME(CBM)
20" standard container	150	750	28
40" standard container	300	1500	56

