



Up-shine[®] Lighting



Technical Application
Guide for UP-SHINE
LED Panel Light

UP-PL2019-10W

Introduction



Super Slim round panel provided in full diameter, adopting SMD led chip. External driver comes with triac dim, it shares great popularity by perfect dimming range and great compatibility with worldwide dimmers. The ultra slim profile fits perfectly for all working places.

- Up to 80% energy saving compared to standard CFL
- Long lifetime of 40,000 hours
- Triac dim
- 120° wide beam angle
- 190mm cutout
- CCT: 3000K 4000K
5000K 5700K
- No UV/IR light
- Environment friendly, without Mercury or any other hazardous substances

Application notes

- IP20 for indoor use only
- Professional electrician for installation only
- Switch off before installation
- Do not touch when in use
- Keep away from hot steam and corrosive gas

Application Areas

Widely used for various commercial lighting and residential lighting applications, such as offices, shopping mall, hotel, restaurant, hospital, home lighting etc.

Certificates



RoHS



Product Information

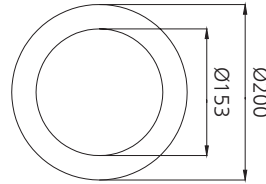

Technical Specifications

Model	Voltage	Power	Power Factor	Lumen (±5%)	Beam angle	CCT	Lifespan	CRI	Dimmable	Dimension
UP-PL2019-10W	AC230V	10W	≥0.9	680	120°	3000K	40000h	≥80	No	Ø200*21mm cutout 190mm
UP-PL2019-10W	AC230V	10W	≥0.9	700	120°	4000K	40000h	≥80	No	Ø200*21mm cutout 190mm
UP-PL2019-10W	AC230V	10W	≥0.9	750	120°	5000K	40000h	≥80	No	Ø200*21mm cutout 190mm
UP-PL2019-10W	AC230V	10W	≥0.9	780	120°	5700K	40000h	≥80	No	Ø200*21mm cutout 190mm
UP-PL2019-10W-D	AC230V	10W	≥0.9	620	120°	3000K	40000h	≥80	Yes	Ø200*21mm cutout 190mm
UP-PL2019-10W-D	AC230V	10W	≥0.9	670	120°	4000K	40000h	≥80	Yes	Ø200*21mm cutout 190mm
UP-PL2019-10W-D	AC230V	10W	≥0.9	700	120°	5000K	40000h	≥80	Yes	Ø200*21mm cutout 190mm
UP-PL2019-10W-D	AC230V	10W	≥0.9	720	120°	5700K	40000h	≥80	Yes	Ø200*21mm cutout 190mm

Driver data Sheet

Driver data	DIM	Non-dim
Input rated Voltage	AC230V	AC230V
Frequency	50HZ	50HZ
Input Voltage	AC200-240V	AC200-240V
Efficiency	≥75%	≥85%
Total load Wattage	10W±1W	10W±1W
Power Factor	≥0.9	≥0.9
Rated input current	≤0.06A	≤0.06A
Full load output Voltage	DC29-33V	DC29-33V
Rated output current	250mA	270mA
Output current range	250mA±5%	270mA±5%
Power tolerance	±5%	±5%
Current output tolerance	±5%	±5%
Dimming range	8%-100%	—
Dimmer	Triac dimmers	—
Short circuit protection	PASS	PASS
Over voltage protection	PASS	PASS
Over temperature protection	PASS	PASS
Withstand voltage	AC3750V	AC3750V

Fixture Compatibility

Rated Wattage	Electrical Classification	Ingress Protection	Operating Temp	Operating Humidity	Storage Temp
10W	II	IP20	-20°C~45°C	0~90%	-20°C~65°C

Spectral Distribution

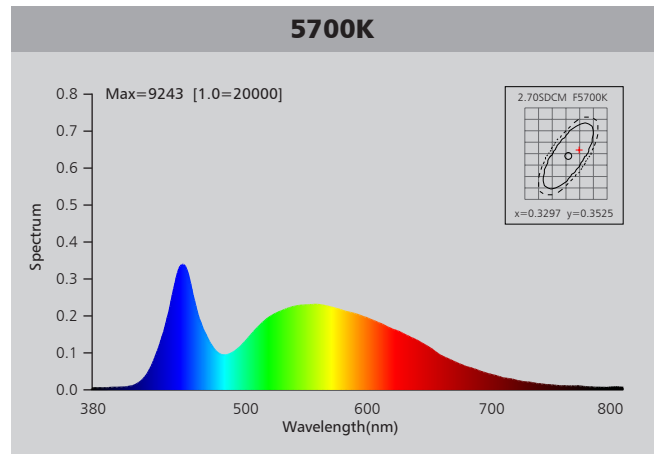
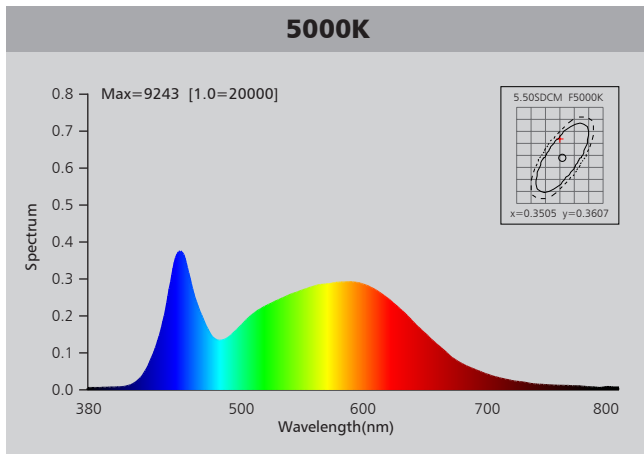
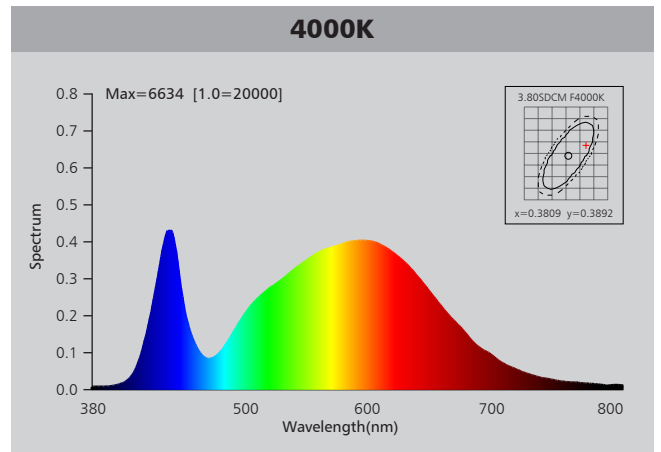
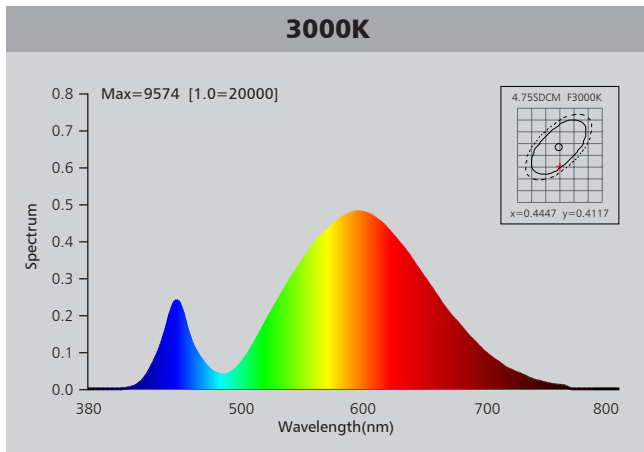

Photometric Diagram

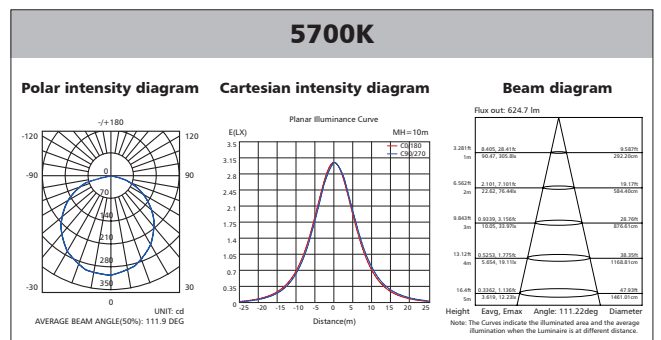
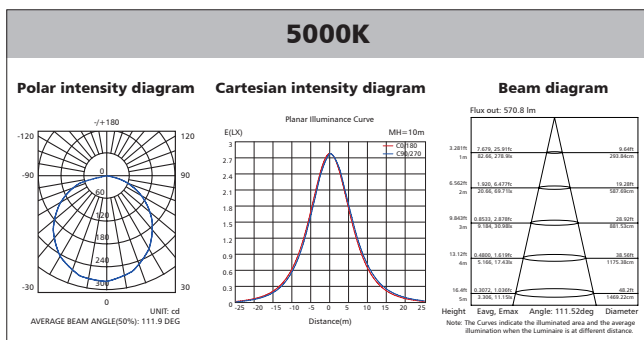
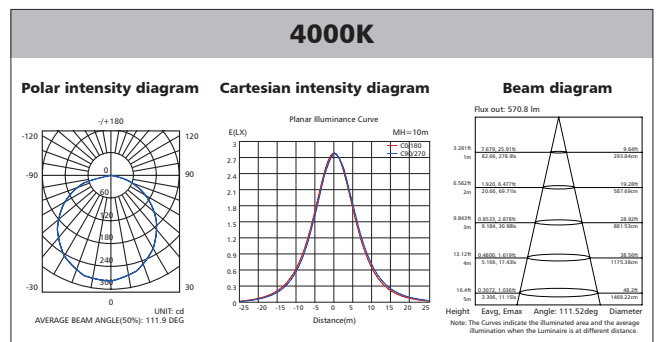
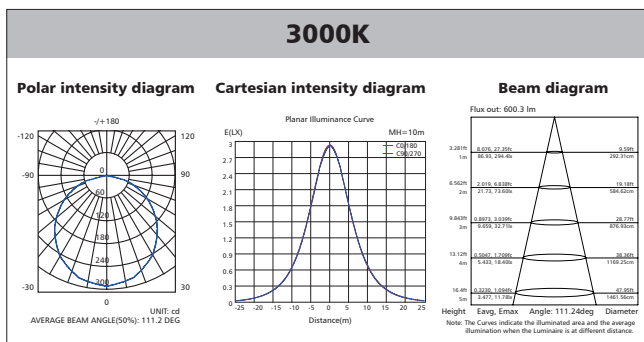

Polar Diagram Comparison

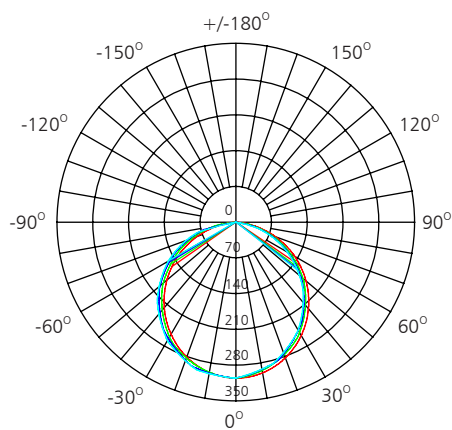

UNIT: cd

- C0/180, 111.2 deg
- C30/210, 111.2 deg
- C60/240, 111.9 deg
- C90/270, 112.3 deg

AVERAGE BEAM ANGLE (50%): 111.6DEG



Driver lifetime & LED light decay rate

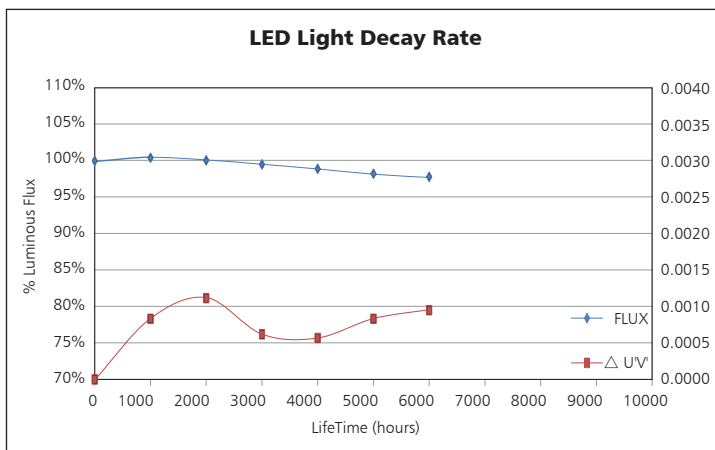
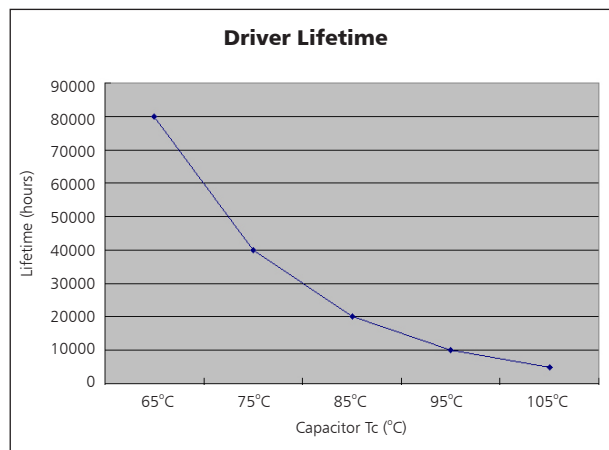

Temperature

- The testing is operated at 25°C
- The lifetime of capacitor, minimum of 5,000 hours if operated at 105°C, will be doubled whenever the temperature drops 10°C
- The highest withstand temperature of IC, MOS could be 120°C
- The highest withstand temperature of LED junction temperature is 150°C

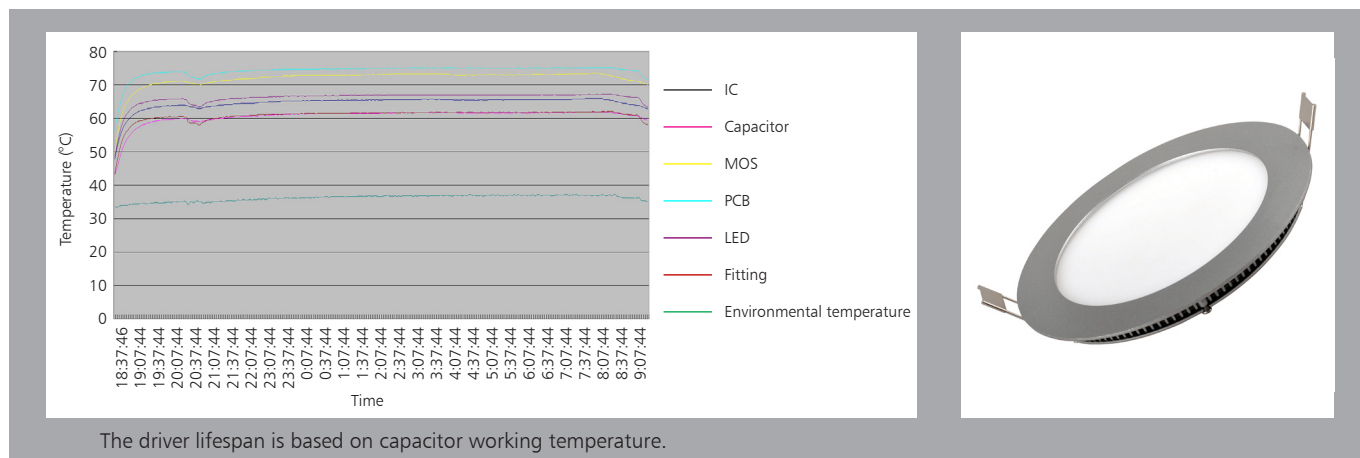

The driver lifespan is based on capacitor working temperature.

Installation

Install requirements	
A-gap above the fitting	25mm
B-gap to the building material	25mm
C-gap to the thermal insulation	25mm

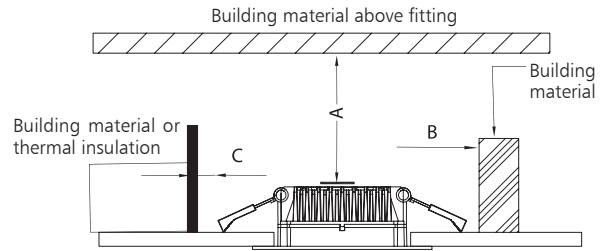

<p>Ceiling opening</p> <p style="text-align: right;">1</p>	<p>Connect Power supply</p> <p style="text-align: right;">2</p>
<p>A. Hold back spring clips B. Push downlight into position</p> <p style="text-align: right;">3</p>	<p>Finish</p> <p style="text-align: right;">4</p>

Packaging Information

	SIZE(CM)	N.W/pc (KGS)	G.W.(KGS)	Q'TY(PCS)
Carton	52.5*25.5*22.5	0.55	7.0	10

	CTNS	Q'TY(PCS)	VOLUME(CBM)
20" standard container	899	9520	28
40" standard container	1798	19040	56

