



Up-shine[®] Lighting



**Technical Application
Guide for UP-SHINE
LED Frameless Panel Light
UP-PL6060-45W-AC**

Introduction



Frameless panel is an improved version compared to regular panels. They are of high lumen output, high CRI > 80, top branded driver with stable working performance. Dimmable version comes with triac dim, 0-10V dim, DALI dim, it shares great popularity by perfect dimming range and great compatibility with worldwide dimmers. The Frameless structural design makes it special and elegant. 5mm thickness diffuser with extremely even light output provides high quality lighting effect.

- Up to 80% energy saving compared to standard CFL
- Long lifetime of 40,000 hours
- 120° wide beam angle
- CCT: 3000K 4000K
5000K 5700K
- No UV/IR light
- Environment friendly, without Mercury or any other hazardous substances

Application notes

- IP40 for indoor use
- Professional electrician for installation only
- Switch off before installation
- Do not touch when in use
- Keep away from hot steam and corrosive gas

Application Areas

Widely used for various commercial lighting and residential lighting applications, such as office, shopping mall, hotel, restaurant, hospital, home lighting etc.

Certificates



RoHS



Product Information

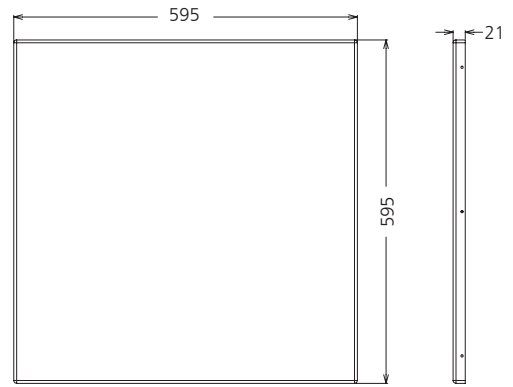

Technical Specifications

Model	Voltage	Power	Power Factor	Lumen (±5%)	Beam angle	CCT	Lifespan	CRI	Dimmable	Dimension
UP-PL6060-45W-AC	AC230V	45W	≥0.9	3420	120°	3000K	40000h	≥80	No	595*595*21mm
UP-PL6060-45W-AC	AC230V	45W	≥0.9	3825	120°	4000K	40000h	≥80	No	595*595*21mm
UP-PL6060-45W-AC	AC230V	45W	≥0.9	3825	120°	5000K	40000h	≥80	No	595*595*21mm
UP-PL6060-45W-AC	AC230V	45W	≥0.9	3910	120°	5700K	40000h	≥80	No	595*595*21mm
UP-PL6060-45W-AC-D	AC230V	45W	≥0.9	3280	120°	3000K	40000h	≥80	Yes	595*595*21mm
UP-PL6060-45W-AC-D	AC230V	45W	≥0.9	3690	120°	4000K	40000h	≥80	Yes	595*595*21mm
UP-PL6060-45W-AC-D	AC230V	45W	≥0.9	3690	120°	5000K	40000h	≥80	Yes	595*595*21mm
UP-PL6060-45W-AC-D	AC230V	45W	≥0.9	3780	120°	5700K	40000h	≥80	Yes	595*595*21mm

Driver data Sheet

Driver data	DIM	Non-dim
Input rated Voltage	AC230V	AC230V
Frequency	50Hz	50Hz
Input Voltage	AC200-240V	AC200-240V
Efficiency	≥84%	≥87%
Total load Wattage	45W±5%	45W±5%
Power Factor	≥0.85	≥0.9
Rated input current	≤0.3A	≤0.3A
Full load output Voltage	DC28-40V	DC24-40V
Rated output current	1050mA	1050mA
Output current range	1050mA±5%	1050mA±5%
Power tolerance	±5%	±5%
Current output tolerance	±5%	±5%
Dimming range	8%-100%	—
Dimmer	Triac dimmers	—
Short circuit protection	PASS	PASS
Over voltage protection	PASS	PASS
Over temperature protection	PASS	PASS
THD	≤20%	≤15%
Withstand voltage	AC3750V	AC3750V

Fixture Compatibility

Rated Wattage	Electrical Classification	Ingress Protection	Operating Temp	Operating Humidity	Storage Temp
45W	II	IP40	-20°C~45°C	0~90%	-20°C~65°C

Spectral Distribution

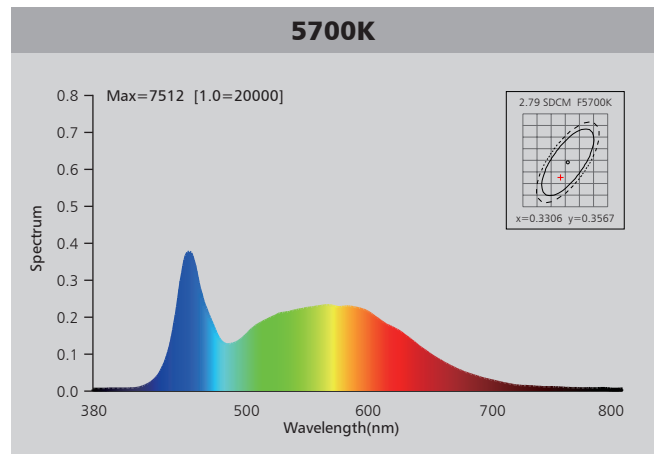
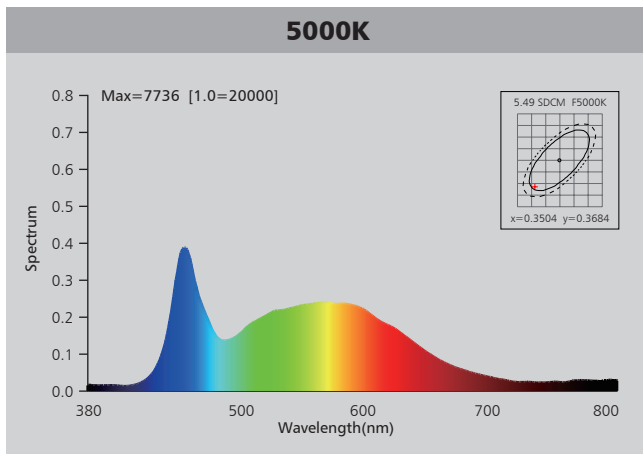
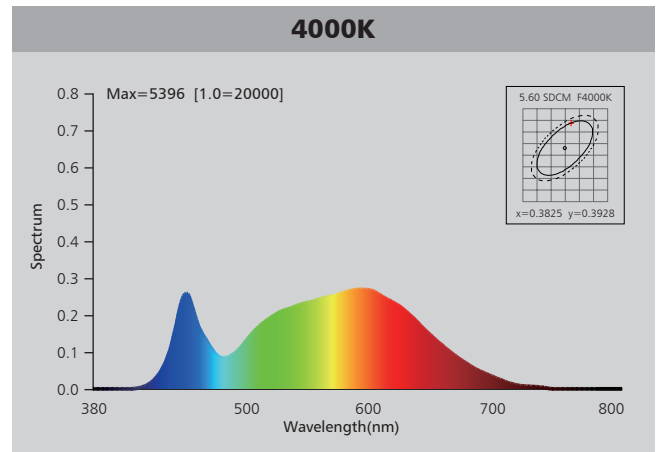
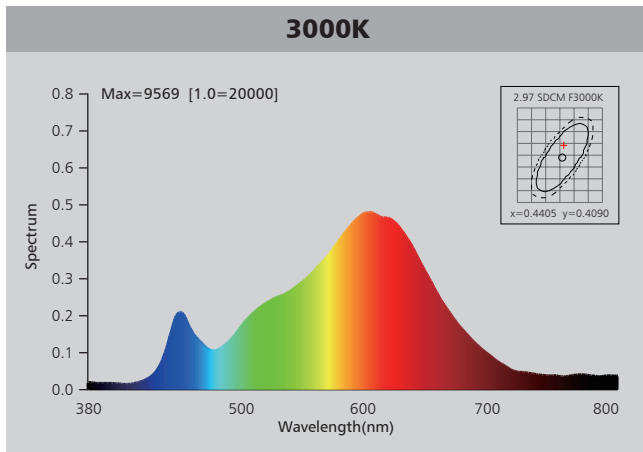

Photometric Diagram

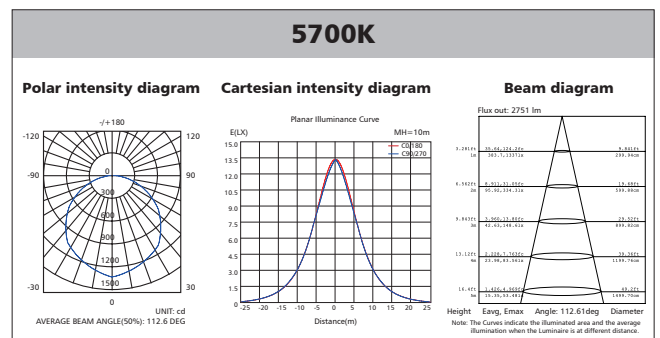
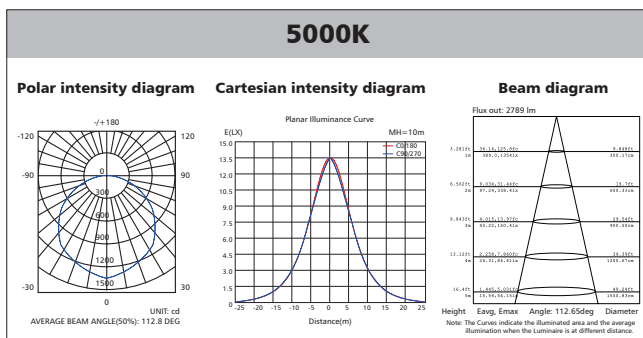
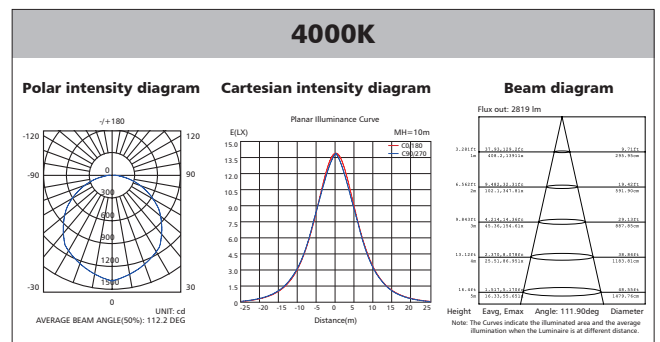
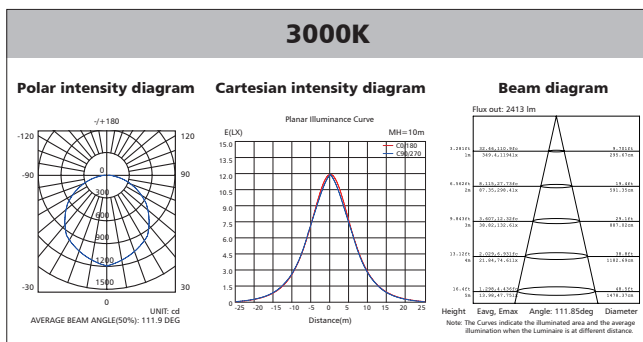

Polar Diagram Comparison

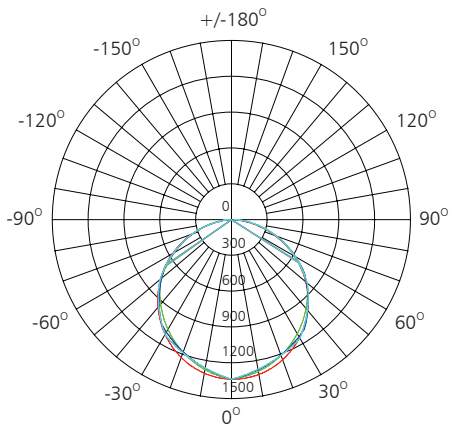

UNIT: cd

- C0/180, 112.6 deg
- C30/210, 111.9 deg
- C60/240, 113.0 deg
- C90/270, 112.8 deg



AVERAGE BEAM ANGLE (50%): 112.6DEG

Driver lifetime & LED light decay rate

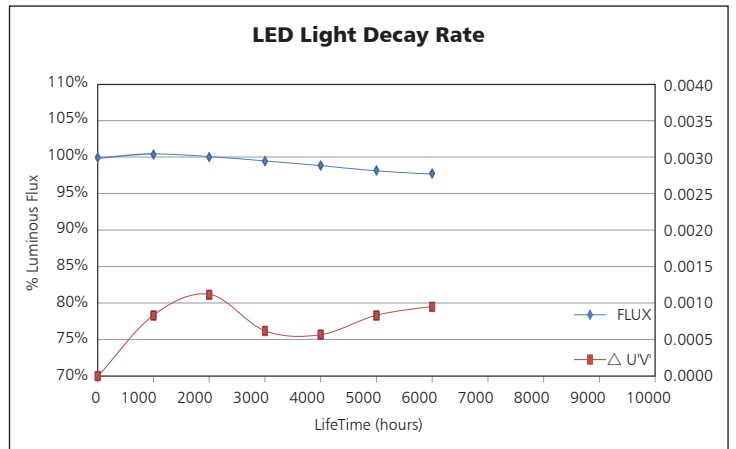
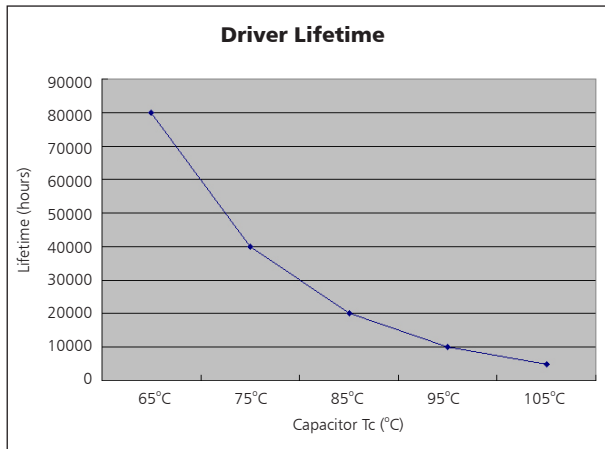

Temperature

- The testing is operated at 25°C
- The lifetime of capacitor, minimum of 5,000 hours if operated at 105°C, will be doubled whenever the temperature drops 10°C
- The highest withstand temperature of IC, MOS could be 120°C
- The highest withstand temperature of LED junction temperature is 150°C

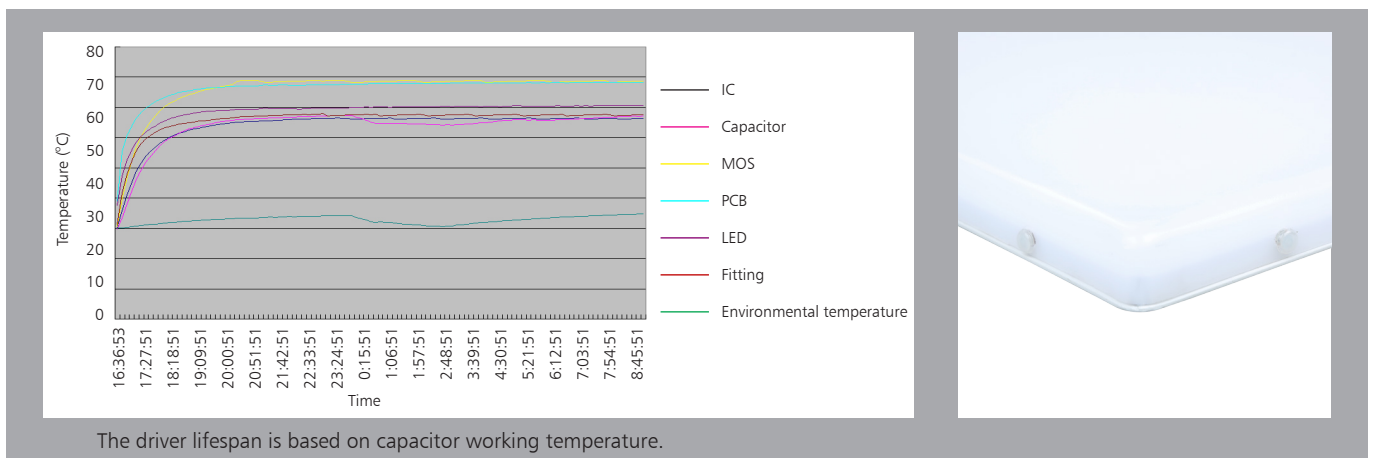

The driver lifespan is based on capacitor working temperature.

Installation

1. Punch the plastic anchor into the ceiling, then fix the holder on the ceiling with screws.

2. Put the steel ropes through the hole of installation hooks on the panel light.

3. Feed the steel ropes to the holder on ceiling and adjust the length of suspending ropes.

4. Feed the main AC wire in driver terminal block respectively, turn on the power.

Packaging Information

	SIZE(CM)	N.W/pc (KGS)	G.W.(KGS)	Q'TY(PCS)
Carton	66.5*37*71.5	4	26	5

	CTNS	Q'TY(PCS)	VOLUME(CBM)
20" standard container	158	790	28
40" standard container	316	1580	56

