

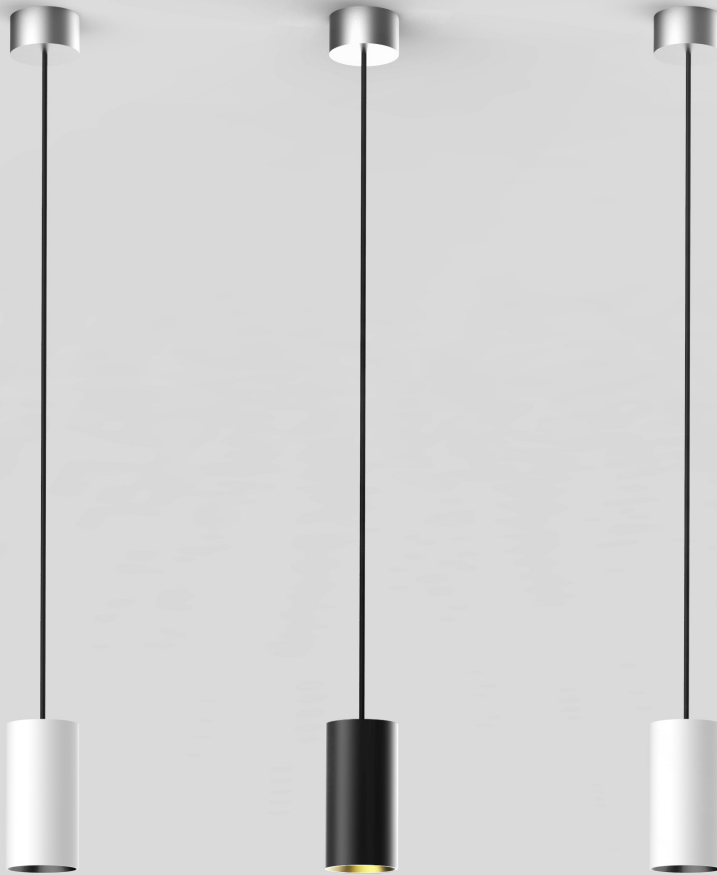

Up-shine<sup>®</sup> Lighting



Technical Application  
Guide for UP-SHINE  
LED Cylinder

UP-PD02A-18W

# Introduction



PD02 whole lamp adopts straightforward design with stylish appearance, easy to install, simple and generous, paying more attention to leisure and comfort. It gives space a clear and lively feelings. The color of surface ring is replaceable, which could create diversified light atmosphere according to different environment.

Suspension wire adopts pull-resistance triple-core wire wrapped with woven cloth. It enhances the tensile strength and easily install compared to steel wire. The lamp adopts high quality reflector which has good reflective rate and light output > 86%. AL6063 Aluminum radiator in sand blast oxidation treatment provides excellent heat dissipation and corrosion resistance. LEDs are high lumen COB chip with CRI>80. Built-in driver is independent and replaceable, which is friendly maintenance. PF>0.9, THD<20%, passed EMC test with strong anti-jamming capability. Besides, it possesses short-circuit protection and overvoltage protection function, showing high safety performance.

- Up to 70% energy saving compared to standard CFL
- Long lifetime of 40,000 hours
- 15°/24°/36° wide beam angle
- CCT: 2700K 3000K  
4000K 5000K
- No UV/IR light
- Environment friendly, without Mercury or any other hazardous substances

## Application notes

- IP40 for indoor use only
- Professional electrician for installation only
- Switch off before installation
- Do not touch when in use
- Keep away from hot steam and corrosive gas

## Application Areas

Applicable for residential lighting in bedroom, living room, corridor etc, also suitable for commercial lighting in office, hotel, restaurant etc.

## Certificate



# Product Information

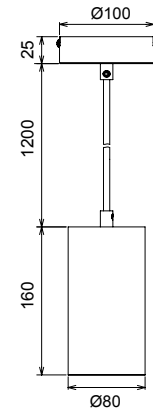

## Technical Specifications

Model	Voltage	Power	Power Factor	Lumen (±5%)	Beam angle	CCT	Lifespan	CRI	Dimmable	Dimension
UP-PD02A-18W	AC100-240V	18W	≥0.9	1400	15°/24°/36°	2700K	40000h	≥80	No	Ø80*160mm
UP-PD02A-18W	AC100-240V	18W	≥0.9	1450	15°/24°/36°	3000K	40000h	≥80	No	Ø80*160mm
UP-PD02A-18W	AC100-240V	18W	≥0.9	1600	15°/24°/36°	4000K	40000h	≥80	No	Ø80*160mm
UP-PD02A-18W	AC100-240V	18W	≥0.9	1660	15°/24°/36°	5000K	40000h	≥80	No	Ø80*160mm
UP-PD02A-18W-D	AC230V	18W	≥0.9	1330	15°/24°/36°	2700K	40000h	≥80	Yes	Ø80*160mm
UP-PD02A-18W-D	AC230V	18W	≥0.9	1370	15°/24°/36°	3000K	40000h	≥80	Yes	Ø80*160mm
UP-PD02A-18W-D	AC230V	18W	≥0.9	1520	15°/24°/36°	4000K	40000h	≥80	Yes	Ø80*160mm
UP-PD02A-18W-D	AC230V	18W	≥0.9	1570	15°/24°/36°	5000K	40000h	≥80	Yes	Ø80*160mm

## Driver data Sheet

Driver data	DIM	Non dim
Input rated Voltage	AC230V	AC100-240V
Frequency	50Hz	50/60Hz
Input Voltage	AC220-240V	AC85-265V
Efficiency	≥85%	≥90%
Total load Wattage	18W±1W	18W±1W
Power Factor	≥0.9	≥0.9
Rated input current	≤0.1A	≤0.2A
Full load output Voltage	DC60-75V	DC60-75V
Rated output current	215mA	230mA
Output current range	215mA±5%	230mA±5%
Power tolerance	±5%	±5%
Current output tolerance	±5%	±5%
Dimming range	8%-100%	—
Dimmer	Triac dimmers	—
Short circuit protection	PASS	PASS
Over voltage protection	PASS	PASS
Over temperature protection	PASS	PASS
THD	≤20%	≤20%
Withstand voltage	—	—

## Fixture Compatibility

Rated Wattage	Electrical Classification	Ingress Protection	Operating Temp	Operating Humidity	Storage Temp
18W	I	IP40	-20°C~45°C	0~90%	-20°C~65°C

# Spectral Distribution

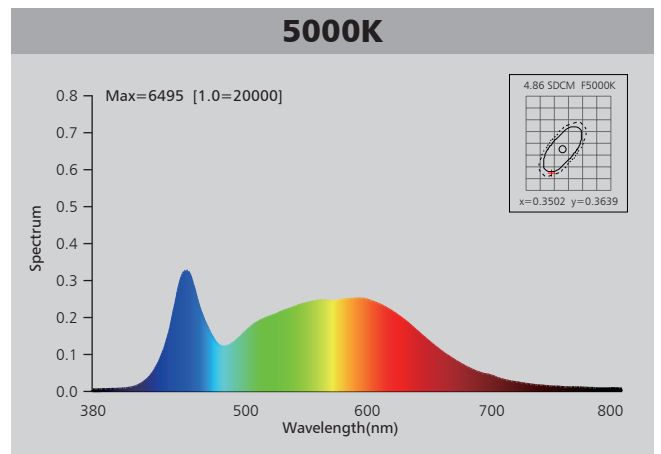
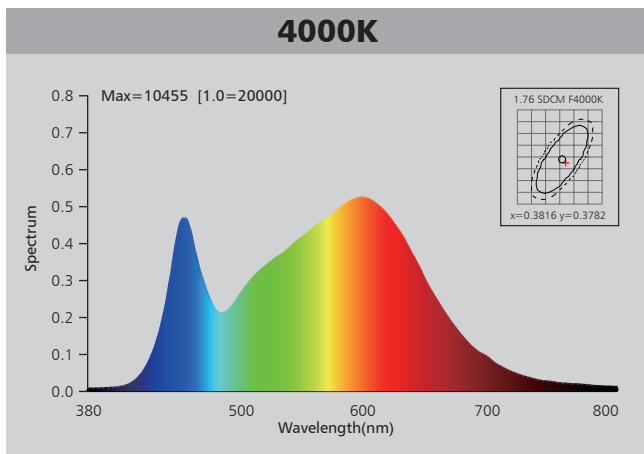
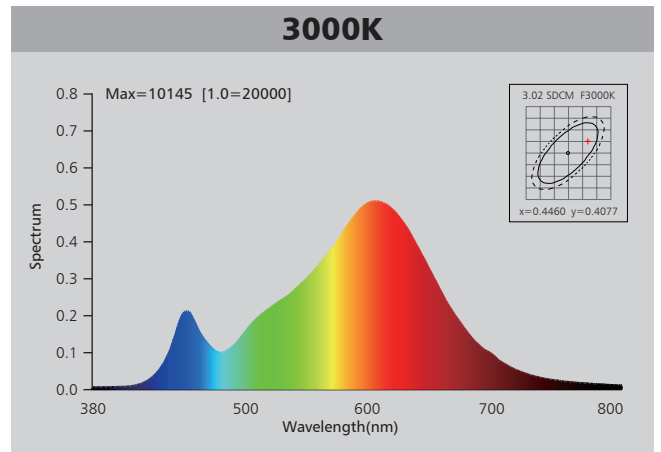
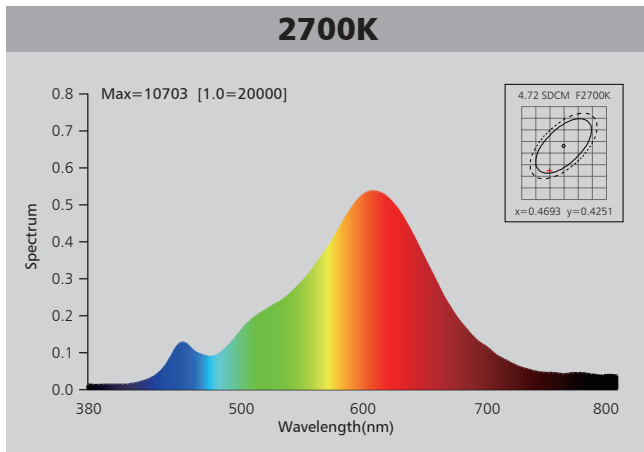

# Photometric Diagram

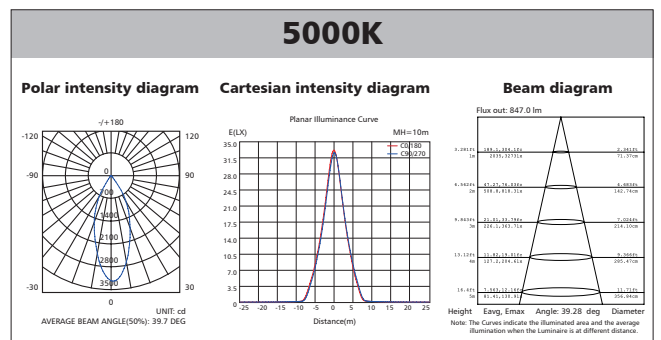
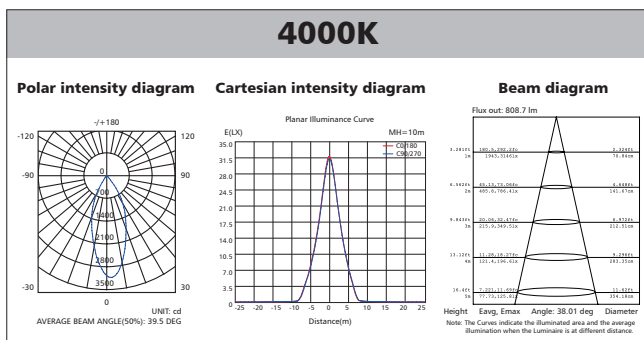
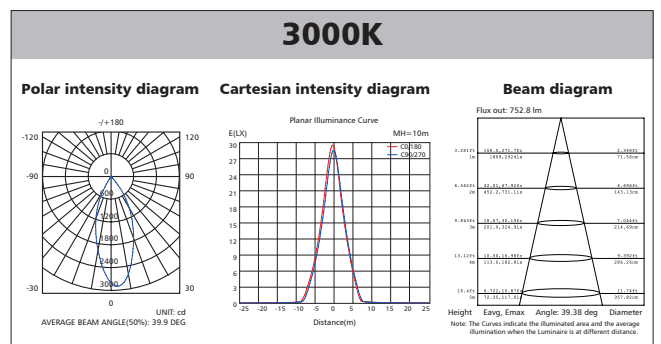
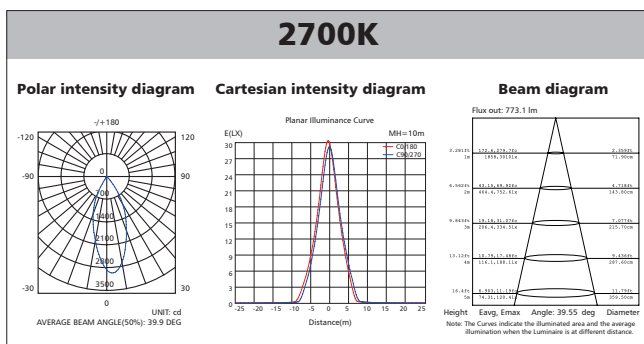

# Polar Diagram Comparison

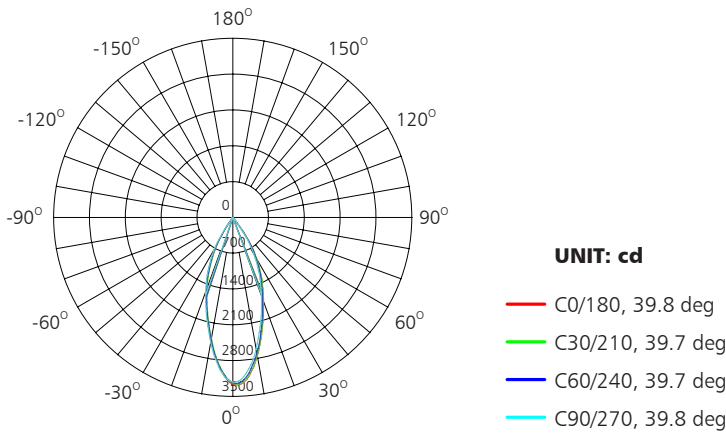

AVERAGE BEAM ANGLE (50%): 39.7DEG

# Driver lifetime & LED light decay rate

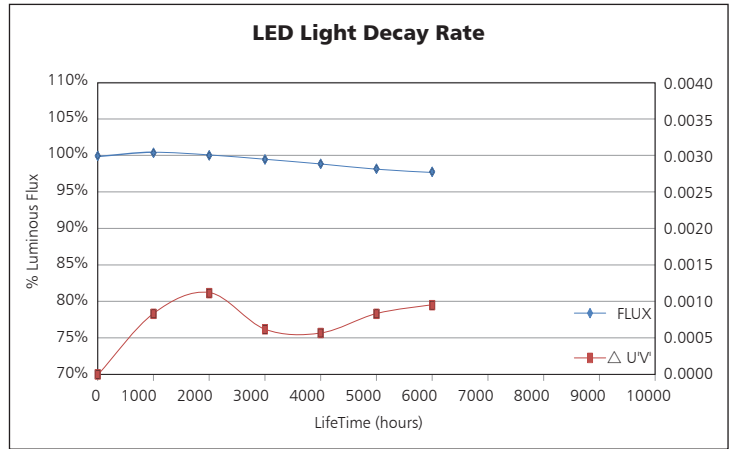
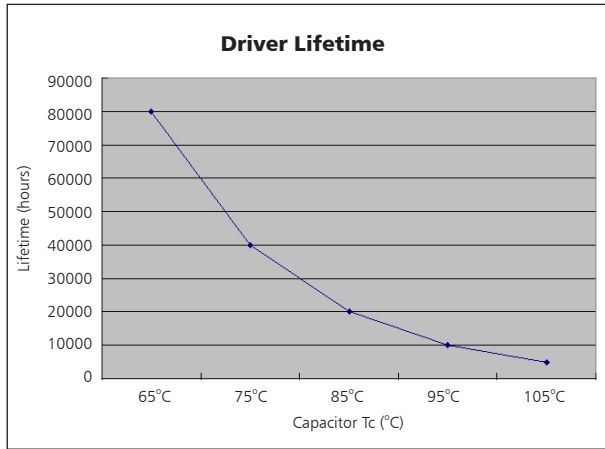

# Temperature

- The testing is operated at 25°C
- The lifetime of capacitor, minimum of 5,000 hours if operated at 105°C, will be doubled whenever the temperature drops 10°C
- The highest withstand temperature of IC, MOS could be 120°C
- The highest withstand temperature of LED junction temperature is 150°C

The driver lifespan is based on capacitor working temperature.

# Installation

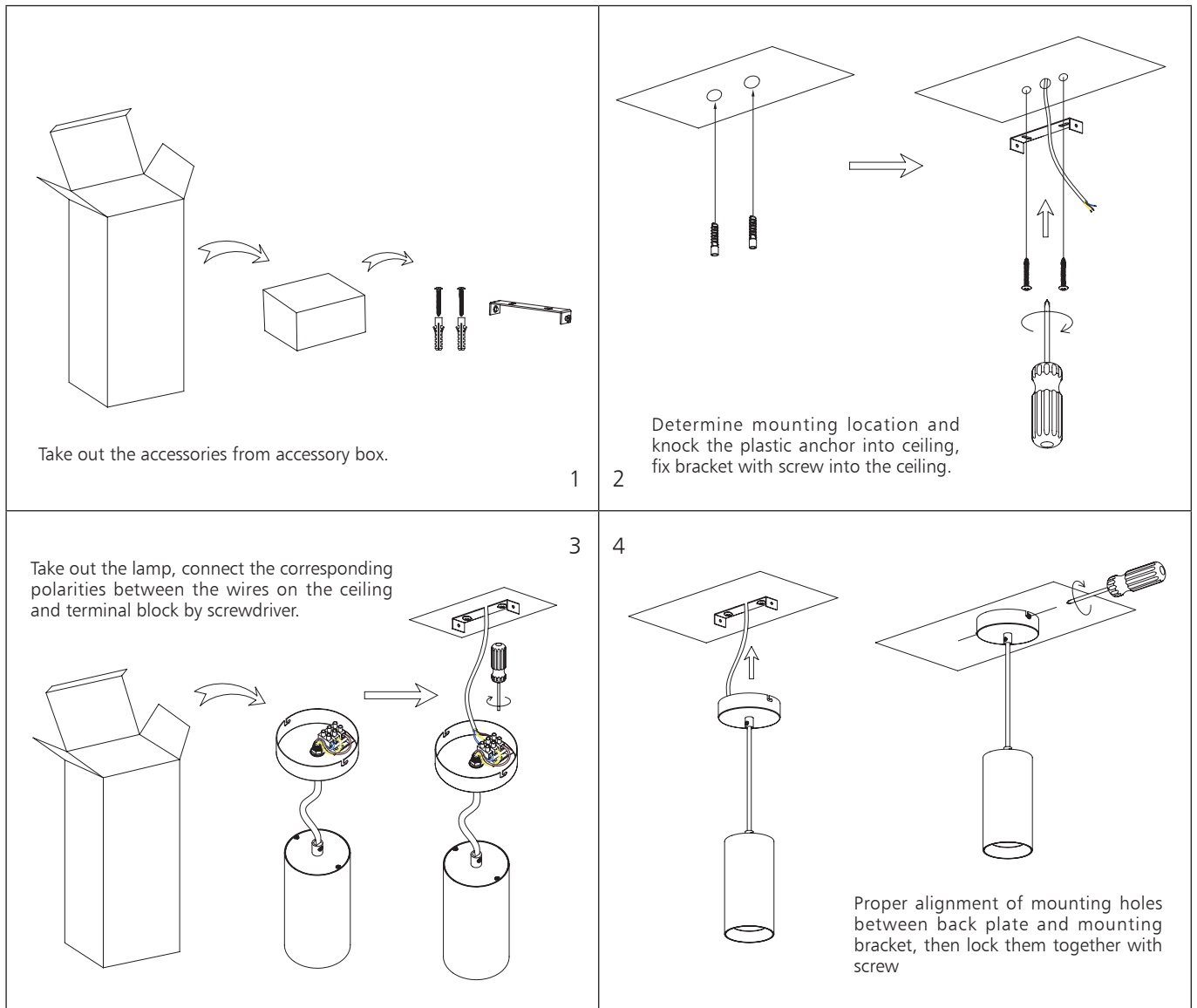

# Packaging Information

	SIZE(CM)	N.W/pc (KGS)	G.W.(KGS)	Q'TY(PCs)
Carton	48*36*47.5	0.81	19.5	24

	CTNS	Q'TY(PCs)	VOLUME(CBM)
20" standard container	337	8088	28
40" standard container	674	16176	56

