



Up-shine® Lighting



Technical Application Guide for UP-SHINE LED Downlight

UP-DL97-2.5-7W-P3



Introduction



Slide switch for color selection

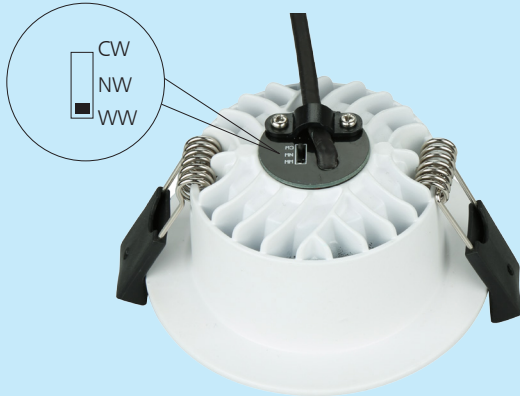

Up-shine SMD LED Down light adopts high lumen SMD LED, PC diffuser with even light output. White, silver, chrome surface treatment are available for customer's preference.

Triac dimmable, 0-10V dimmable and DALI dimmable version share great popularity by excellent dimming effect.

- Up to 70% energy saving compared to standard CFL
- Long lifetime of 50,000 hours
- Dimmable when using triac dimmer
- 90° wide beam angle
- Ø70-75mm cutout
- CCT: 3000K-4000K-5700K
- No UV/IR light
- Environment friendly, without Mercury or any other hazardous substances

Application notes

- IP54 for indoor use
- Professional electrician for installation only
- Switch off before installation
- Do not touch when in use
- Keep away from hot steam and corrosive gas

Application Areas

It is designed for general lighting applications in office, supermarket, shop, school, hotel, etc. It is also widely used for public areas, such as stairway, lobby, reception, corridors etc.

Certificate

CE RoHS



Product Information

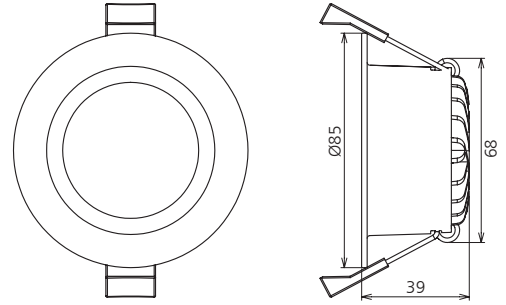

Technical Specifications

Model	Voltage	Power	Power Factor	Lumen (±5%)	Beam angle	CCT	Lifespan	CRI	Dimmable	Dimension
UP-DL97-2.5-7W-C3	AC230V	7W	≥0.9	500	90°	3000K	50000h	≥80	No	Ø85*39mm cutout 70-75mm
UP-DL97-2.5-7W-C3	AC230V	7W	≥0.9	600	90°	4000K	50000h	≥80	No	Ø85*39mm cutout 70-75mm
UP-DL97-2.5-7W-C3	AC230V	7W	≥0.9	560	90°	5700K	50000h	≥80	No	Ø85*39mm cutout 70-75mm
UP-DL97-2.5-7W-P3	AC230V	7W	≥0.9	490	90°	3000K	50000h	≥80	Yes	Ø85*39mm cutout 70-75mm
UP-DL97-2.5-7W-P3	AC230V	7W	≥0.9	590	90°	4000K	50000h	≥80	Yes	Ø85*39mm cutout 70-75mm
UP-DL97-2.5-7W-P3	AC230V	7W	≥0.9	550	90°	5700K	50000h	≥80	Yes	Ø85*39mm cutout 70-75mm

Driver data Sheet

Driver data	DIM	Non dim
Input rated Voltage	AC230V	AC230V
Frequency	50Hz	50/60Hz
Input Voltage	AC200-240V	AC200-240V
Efficiency	≥78%	≥82%
Total load Wattage	7W±0.5W	7W±0.5W
Power Factor	≥0.9	≥0.9
Rated input current	≤0.04A	≤0.04A
Full load output Voltage	DC24-32V	DC25-33V
Rated output current	195mA	220mA
Output current range	195mA±5%	220mA±5%
Power tolerance	±5%	±5%
Current output tolerance	±5%	±5%
Dimming range	8%-100%	—
Dimmer	Triac dimmers	—
Short circuit protection	PASS	PASS
Over voltage protection	PASS	PASS
Over temperature protection	PASS	PASS
THD	≤20%	≤18%
Withstand voltage	AC3750V	AC3750V

Fixture Compatibility

Rated Wattage	Electrical Classification	Ingress Protection	Operating Temp	Operating Humidity	Storage Temp
7W	II	IP54	-20°C~45°C	0~90%	-20°C~65°C

Spectral Distribution

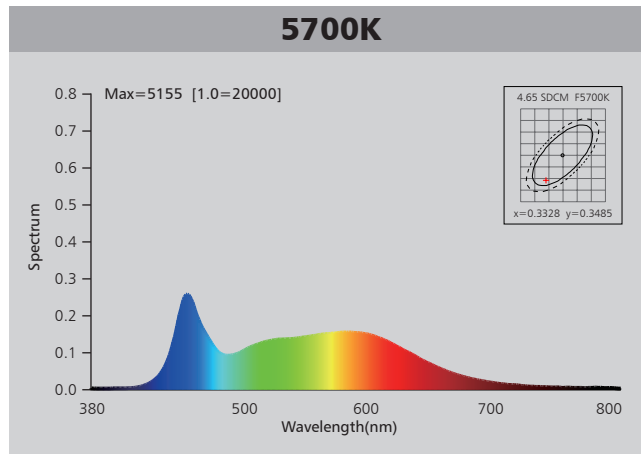
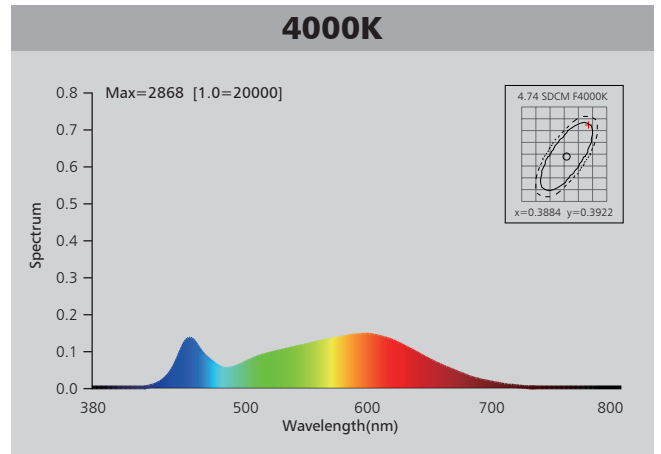
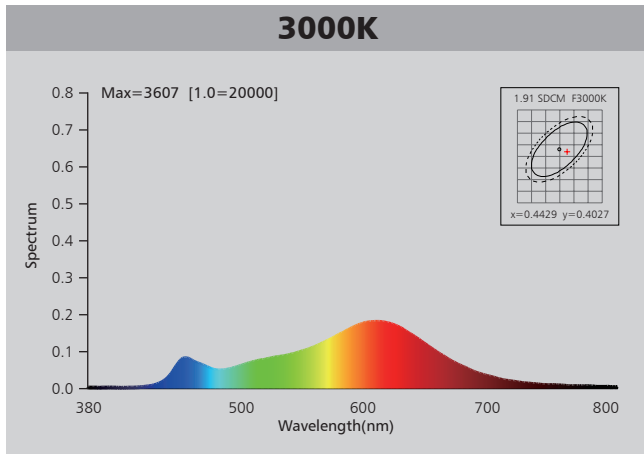

Photometric Diagram

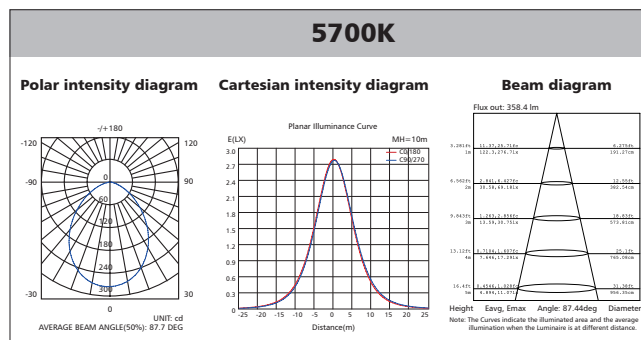
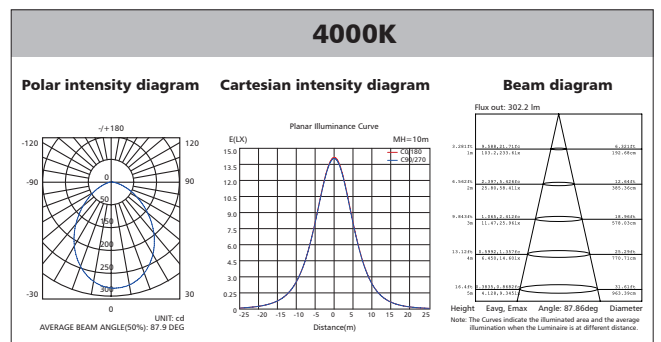
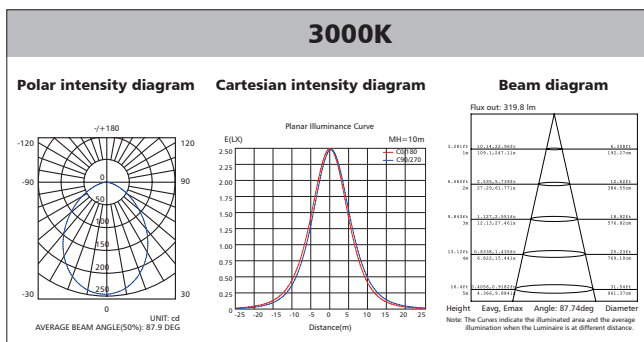

Polar Diagram Comparison

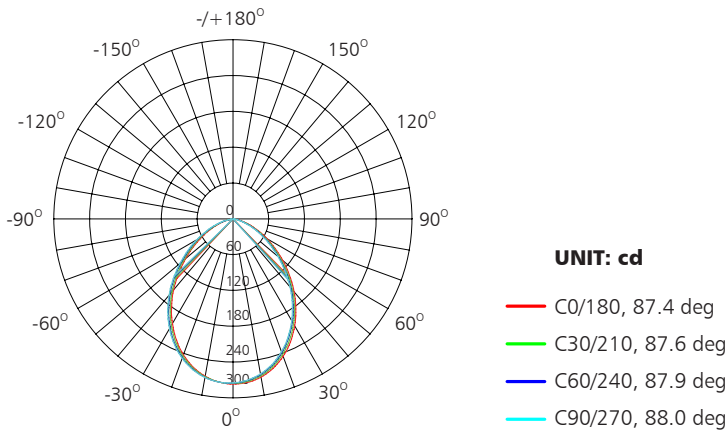

AVERAGE BEAM ANGLE (50%): 87.7DEG



Driver lifetime & LED light decay rate

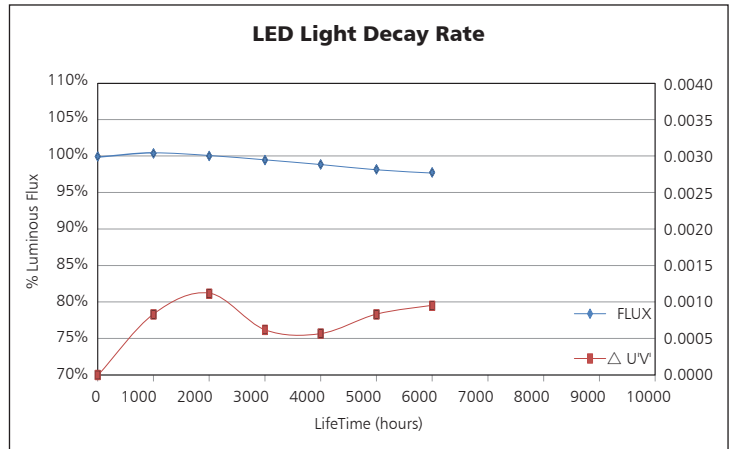
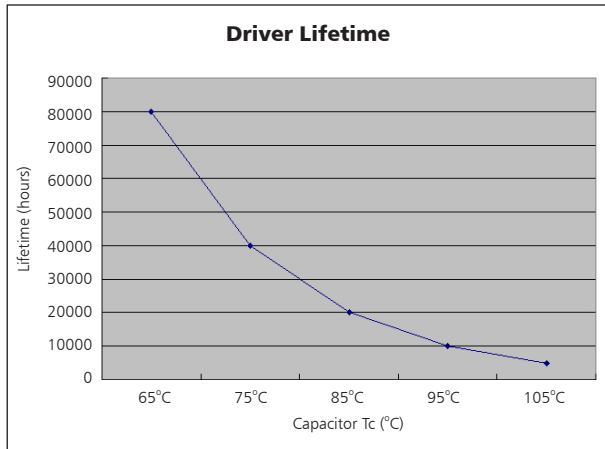

Temperature

- The testing is operated at 25°C
- The lifetime of capacitor, minimum of 5,000 hours if operated at 105°C, will be doubled whenever the temperature drops 10°C
- The highest withstand temperature of IC, MOS could be 120°C
- The highest withstand temperature of LED junction temperature is 150°C

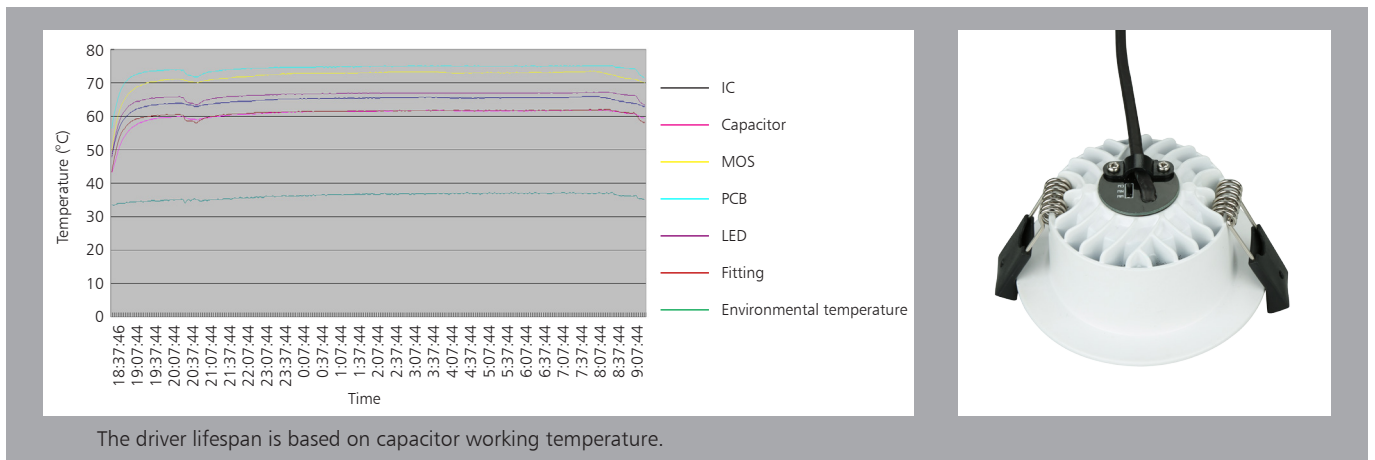

Installation

For the product with Slide Switch of Color Selection, please select the light color (CW/NW/WW) before installation.

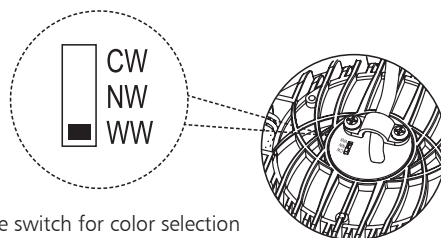

Slide switch for color selection

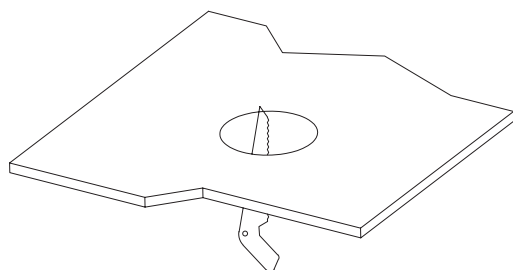

1. Open a hole according to the cutout size of led downlight.

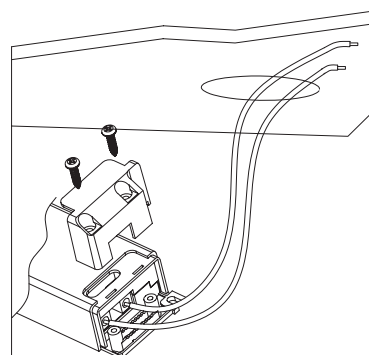

2. Use screw-driver to open the driver terminal cover, feed the main AC wire L. N. in terminal block respectively, then fix the cover back.

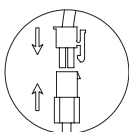
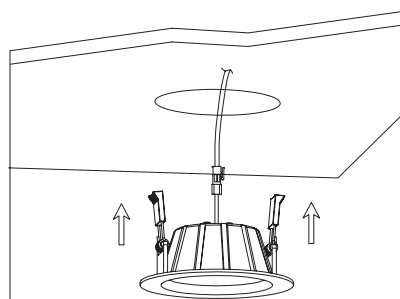

3. Connect the downlight with driver, hold back the spring clip then push the downlight into the hole.

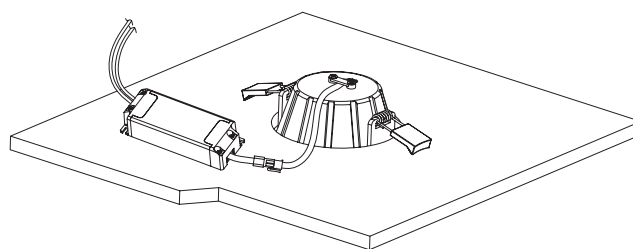

4. Make sure the downlight fixed tightly in ceiling, turn on the power (Fig 1).

Packaging Information

	SIZE(CM)	N.W/pc (KGS)	G.W.(KGS)	Q'TY(PCS)
Carton	57.5*57.5*20	0.2	12.5	50

	CTNS	Q'TY(PCS)	VOLUME(CBM)
20" standard container	410	20500	28
40" standard container	830	41500	56

