



Up-shine[®] Lighting



Technical Application
Guide for UP-SHINE
LED Anti glare
Downlight

UP-DL83-8-35W

Introduction



DL83 New Design LED Downlight is a perfect combination of high lumen and anti-glare performance for Australian and European market. The lamp adopts high efficiency SMD2835 led chip, which makes light efficiency reach 90-100lm/w, much higher than traditional downlight. The diffuser adopts anti glare PMMA of which glaze surface inwards and the diamond surface outwards to create the most comfortable lighting environment. The heat sink adopts cold forging treatment AL1070 pure aluminum with excellent heat dissipation performance and very light. Meanwhile, oxidation surface treatment keeps the heat sink surface smooth and anti-corrosive for a long time, besides the downlight equips with high efficiency external led driver: PF>0.9, THD<20%, extending greatly the life span of downlight. The DL83 whole series include 3 inch-13w, 6 inch-25w and 8 inch-35w, dimmable and non-dimmable functions for optional, can perfectly match the most of triac dimmers in the market.

- Up to 70% energy saving compared to standard CFL
- Long lifetime of 40,000 hours
- 60° wide beam angle
- Ø200-220mm cutout
- CCT: 3000K 4000K
5000K 5700K
- Adjustable and rotary
- No UV/IR light
- Environment friendly, without Mercury or any other hazardous substances

Application notes

- IP20 for indoor use only
- Professional electrician for installation only
- Switch off before installation
- Do not touch when in use
- Keep away from hot steam and corrosive gas

Application Areas

It is designed for general lighting applications in office, supermarket, shop, school, hotel, etc. It is also widely used for public areas, such as stairway, lobby, reception, corridors etc.

Certificate



RoHS



Product Information

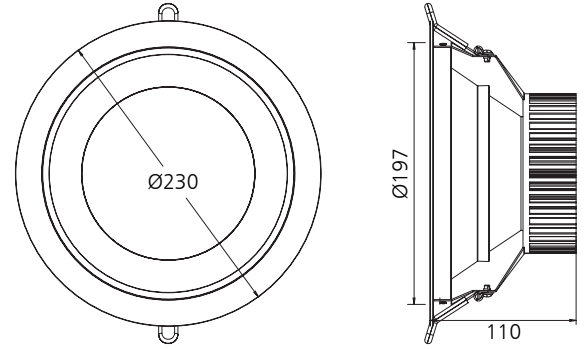

Technical Specifications

Model	Voltage	Power	Power Factor	Lumen (±5%)	Beam angle	CCT	Lifespan	CRI	Dimmable	Dimension
UP-DL83-8-35W	AC230V	35W	≥0.9	3300	60°	3000K	40000h	≥80	No	Ø230*110mm cutout 200-220mm
UP-DL83-8-35W	AC230V	35W	≥0.9	3370	60°	4000K	40000h	≥80	No	Ø230*110mm cutout 200-220mm
UP-DL83-8-35W	AC230V	35W	≥0.9	3360	60°	5000K	40000h	≥80	No	Ø230*110mm cutout 200-220mm
UP-DL83-8-35W	AC230V	35W	≥0.9	3700	60°	5700K	40000h	≥80	No	Ø230*110mm cutout 200-220mm
UP-DL83-8-35W-D	AC230V	35W	≥0.9	3320	60°	3000K	40000h	≥80	Yes	Ø230*110mm cutout 200-220mm
UP-DL83-8-35W-D	AC230V	35W	≥0.9	3350	60°	4000K	40000h	≥80	Yes	Ø230*110mm cutout 200-220mm
UP-DL83-8-35W-D	AC230V	35W	≥0.9	3300	60°	5000K	40000h	≥80	Yes	Ø230*110mm cutout 200-220mm
UP-DL83-8-35W-D	AC230V	35W	≥0.9	3560	60°	5700K	40000h	≥80	Yes	Ø230*110mm cutout 200-220mm

Driver data Sheet

Driver data	DIM	Non dim
Input rated Voltage	AC230V	AC230V
Frequency	50Hz	50Hz
Input Voltage	AC200-240V	AC200-240V
Efficiency	≥84%	≥85%
Total load Wattage	35W±5%	35W±5%
Power Factor	≥0.9	≥0.9
Rated input current	≤0.2A	≤0.2A
Full load output Voltage	DC23-40V	DC27-40V
Rated output current	800mA	800mA
Output current range	800mA±5%	800mA±5%
Power tolerance	±5%	±5%
Current output tolerance	±5%	±5%
Dimming range	8%-100%	—
Dimmer	Triac dimmers	—
Short circuit protection	PASS	PASS
Over voltage protection	PASS	PASS
Over temperature protection	PASS	PASS
THD	≤18%	≤18%
Withstand voltage	AC3750V	AC3750V

Fixture Compatibility

Rated Wattage	Electrical Classification	Ingress Protection	Operating Temp	Operating Humidity	Storage Temp
35W	II	IP20	-20°C~45°C	0~90%	-20°C~65°C

Spectral Distribution

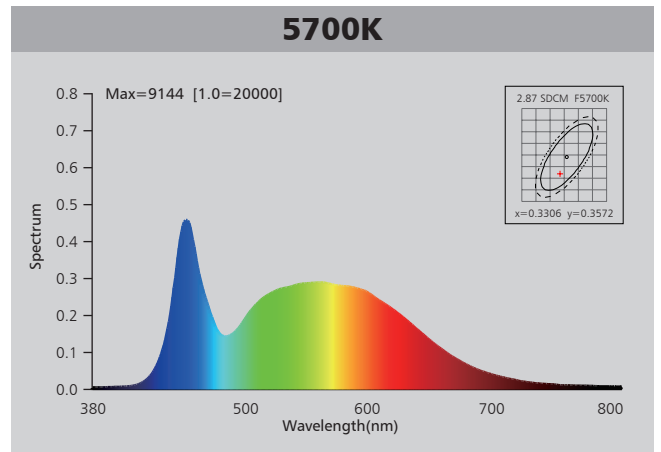
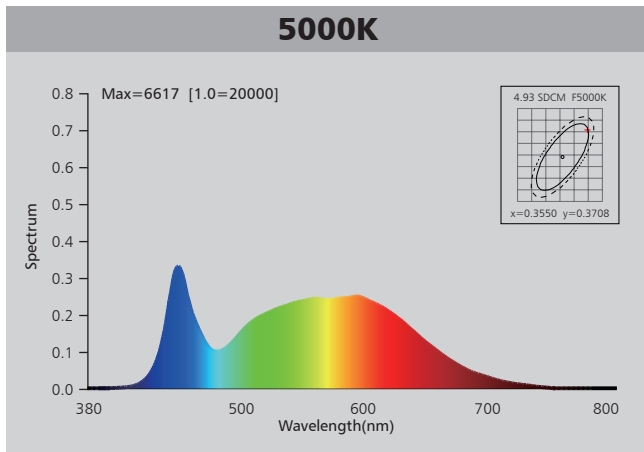
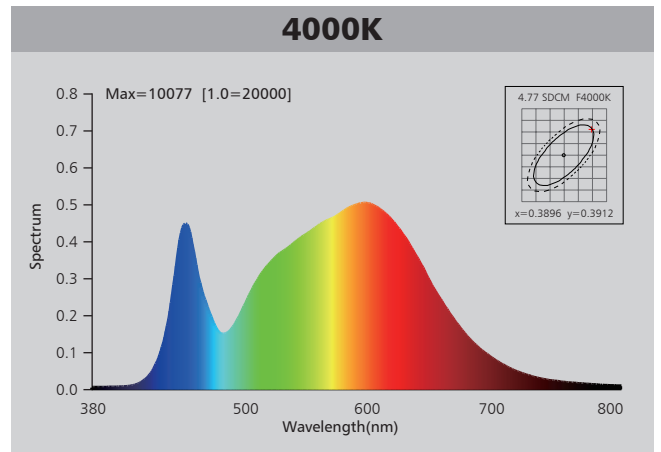
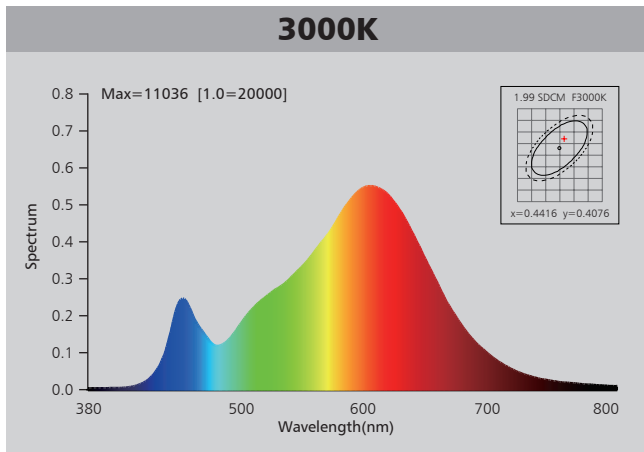

Photometric Diagram

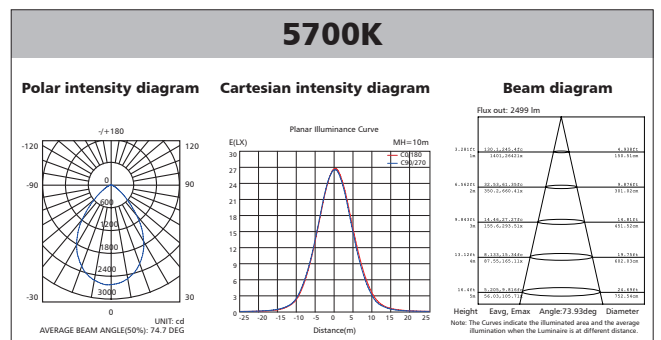
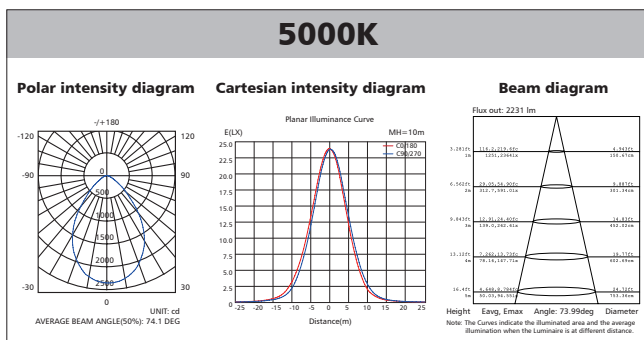
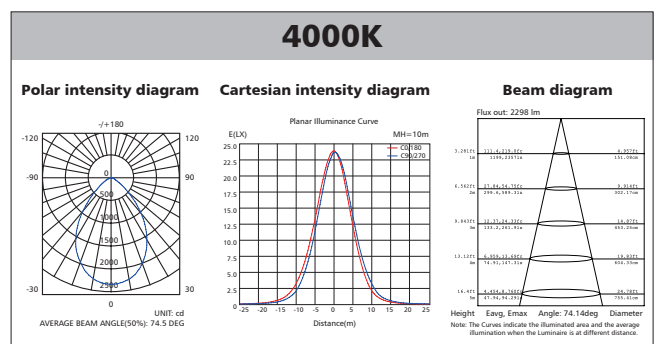
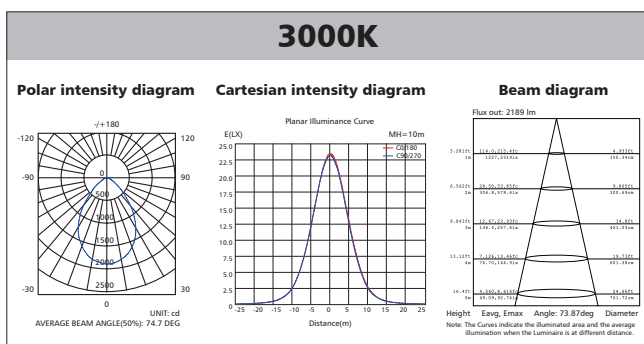

Polar Diagram Comparison

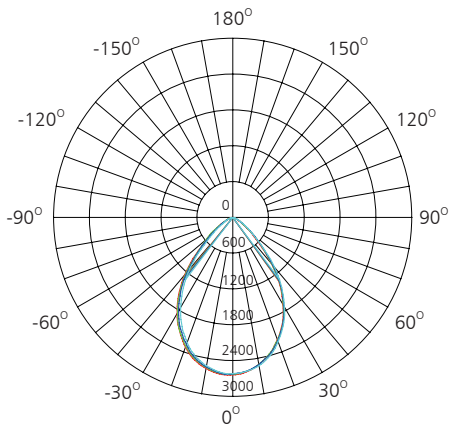

UNIT: cd

- C0/180, 74.9 deg
- C30/210, 74.9 deg
- C60/240, 74.6 deg
- C90/270, 74.2 deg

AVERAGE BEAM ANGLE (50%): 74.7DEG



Driver lifetime & LED light decay rate

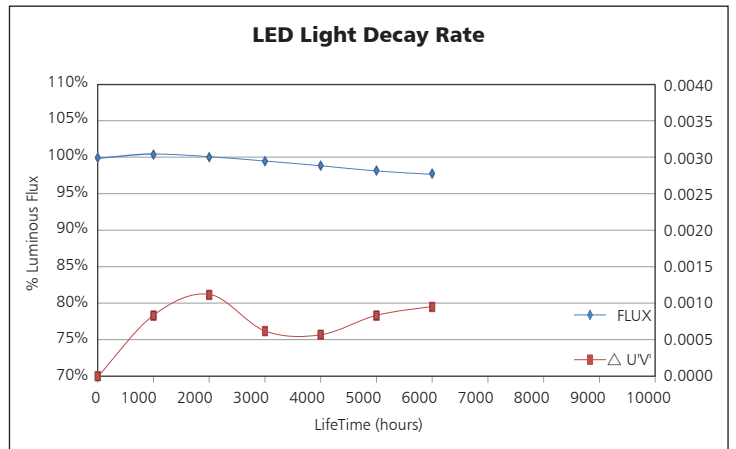
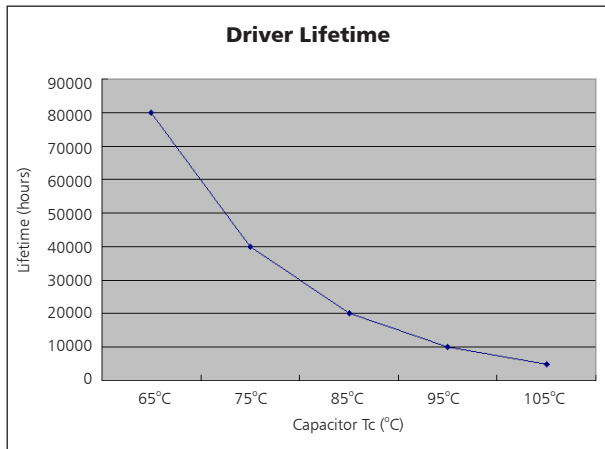

Temperature

- The testing is operated at 25°C
- The lifetime of capacitor, minimum of 5,000 hours if operated at 105°C, will be doubled whenever the temperature drops 10°C
- The highest withstand temperature of IC, MOS could be 120°C
- The highest withstand temperature of LED junction temperature is 150°C

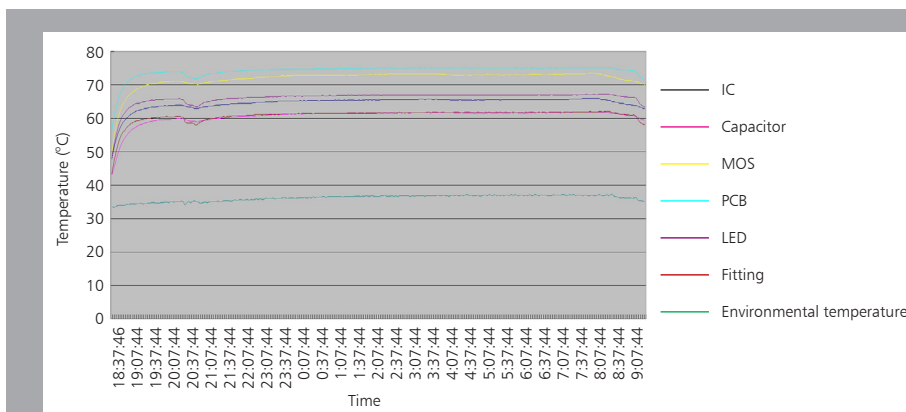

The driver lifespan is based on capacitor working temperature.

Installation

Install requirements	
A-gap above the fitting	25mm
B-gap to the building material	25mm
C-gap to the thermal insulation	25mm

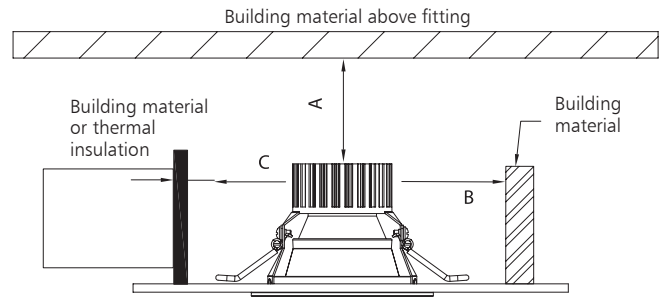

<p>Ceiling opening</p> <p style="text-align: right;">1</p>	<p style="text-align: right;">2</p>
<p>A. Hold back spring clips</p> <p>B. Push downlight into position</p> <p style="text-align: right;">3</p>	<p>Finish</p> <p style="text-align: right;">4</p>

Packaging Information

	SIZE(CM)	N.W/pc (KGS)	G.W.(KGS)	Q'TY(PCS)
Carton	53*53*40	0.98	13	12

	CTNS	Q'TY(PCS)	VOLUME(CBM)
20" standard container	246	2952	28
40" standard container	492	5904	56

