



Up-shine® Lighting



Technical Application
Guide for UP SHINE
LED Scoop Downlight

UP-DL77-4-15W

Introduction

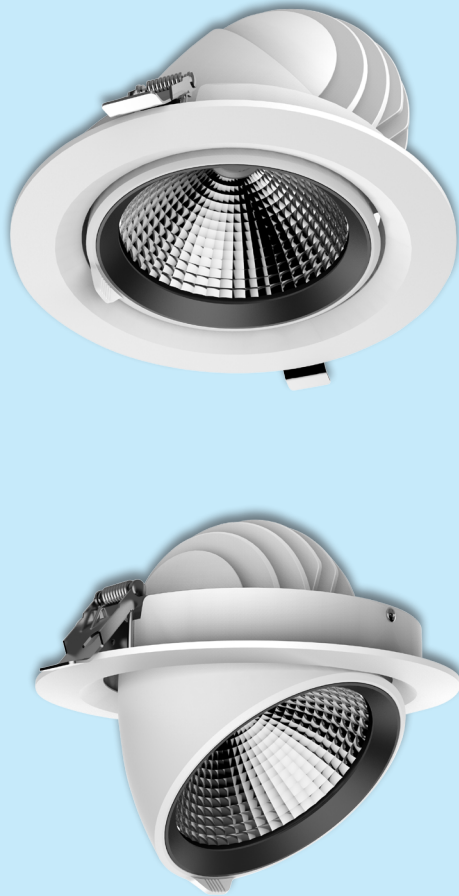

Up-shine COB downlight is unique designed with reflector and Citizen COB high power LED chip. ADC12 die-casting aluminium profile provides excellent thermal dissipation. Adjustable lighting direction provides all possible lighting effects. Isolated driver solution both in dimmable and non-dimmable version achieves great dimming compatibility with worldwide brand dimmers.

- Up to 70% energy saving compared to standard CFL
- Long lifetime of 40,000 hours
- Dimmable when using triac dimmer
- 15°/24°/36°/60° wide beam angle
- Ø120-130mm cutout
- CCT: 2700K 3000K
4000K 5000K
- No UV/IR light
- Environment friendly, without Mercury or any other hazardous substances

Application notes

- IP20 for indoor use only
- Professional electrician for installation only
- Switch off before installation
- Do not touch when in use
- Keep away from hot steam and corrosive gas

Application Areas

It is designed for general lighting applications in office, supermarket, shop, school, hotel, etc. It is also widely used for public areas, such as stairway, lobby, reception, corridors etc.

Certificate

CE RoHS



Product Information

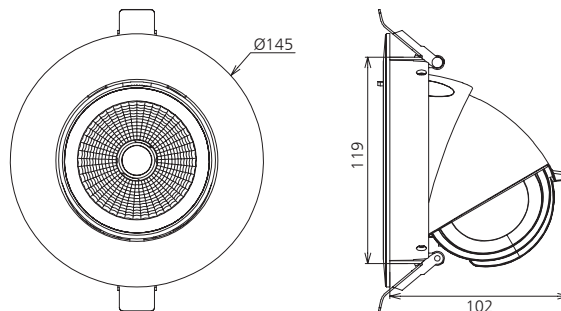

Technical Specifications

Model	Voltage	Power	Power Factor	Lumen (±5%)	Beam angle	CCT	Lifespan	CRI	Dimmable	Dimension
UP-DL77-4-15W	AC230V	15W	≥0.9	1125	15°/24°/36°/60°	2700K	40000h	≥80	No	Ø145*102mm cutout Ø120-130mm
UP-DL77-4-15W	AC230V	15W	≥0.9	1150	15°/24°/36°/60°	3000K	40000h	≥80	No	Ø145*102mm cutout Ø120-130mm
UP-DL77-4-15W	AC230V	15W	≥0.9	1230	15°/24°/36°/60°	4000K	40000hs	≥80	No	Ø145*102mm cutout Ø120-130mm
UP-DL77-4-15W	AC230V	15W	≥0.9	1290	15°/24°/36°/60°	5000K	40000h	≥80	No	Ø145*102mm cutout Ø120-130mm
UP-DL77-4-15W-D	AC230V	15W	≥0.9	1060	15°/24°/36°/60°	2700K	40000h	≥80	Yes	Ø145*102mm cutout Ø120-130mm
UP-DL77-4-15W-D	AC230V	15W	≥0.9	1090	15°/24°/36°/60°	3000K	40000h	≥80	Yes	Ø145*102mm cutout Ø120-130mm
UP-DL77-4-15W-D	AC230V	15W	≥0.9	1150	15°/24°/36°/60°	4000K	40000h	≥80	Yes	Ø145*102mm cutout Ø120-130mm
UP-DL77-4-15W-D	AC230V	15W	≥0.9	1230	15°/24°/36°/60°	5000K	40000h	≥80	Yes	Ø145*102mm cutout Ø120-130mm

Driver data Sheet

Driver data	DIM	Non dim
Input rated Voltage	AC230V	AC230V
Frequency	50Hz	50Hz
Input Voltage	AC200-240V	AC200-240V
Efficiency	≥80%	≥85%
Total load Wattage	15W±1W	15W±1W
Power Factor	≥0.9	≥0.9
Rated input current	≤0.09A	≤0.09A
Full load output Voltage	DC23-40V	DC25-42V
Rated output current	350mA	350mA
Output current range	350mA±5%	350mA±5%
Power tolerance	±5%	±5%
Current output tolerance	±5%	±5%
Dimming range	8%-100%	—
Dimmer	Triac dimmers	—
THD	<18%	<18%
Short circuit protection	PASS	PASS
Over voltage protection	PASS	PASS
Over temperature protection	PASS	PASS
Withstand voltage	AC3750V	AC3750V

Fixture Compatibility

Rated Wattage	Electrical Classification	Ingress Protection	Operating Temp	Operating Humidity	Storage Temp
15W	II	IP20	-20°C~45°C	0~90%	-20°C~65°C

Spectral Distribution

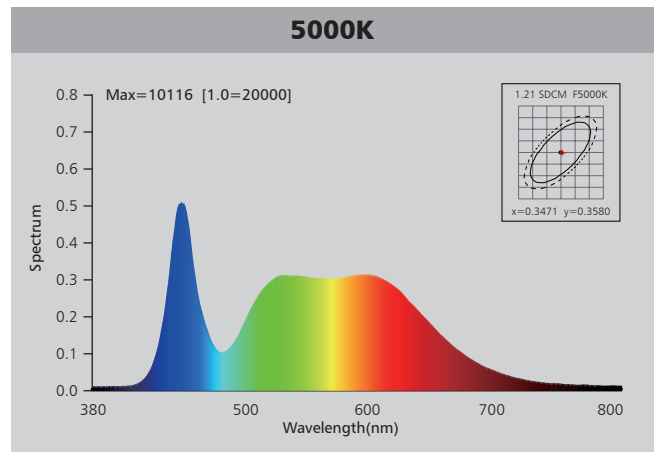
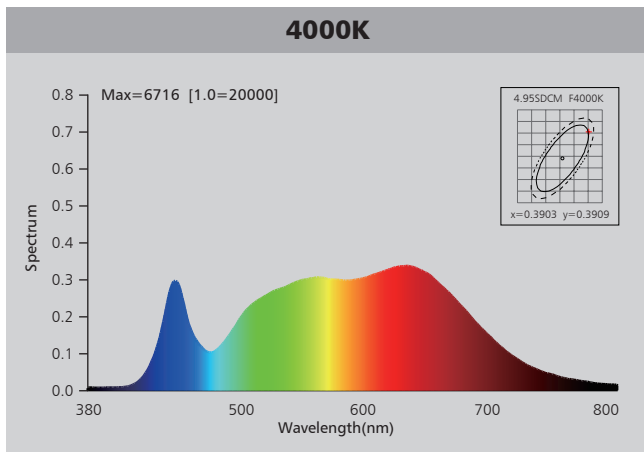
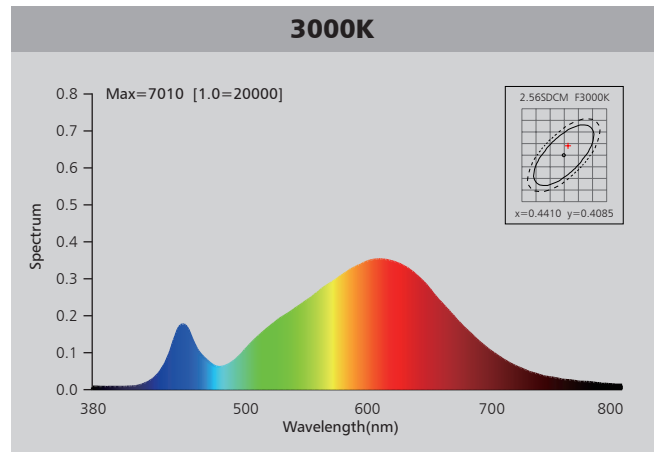
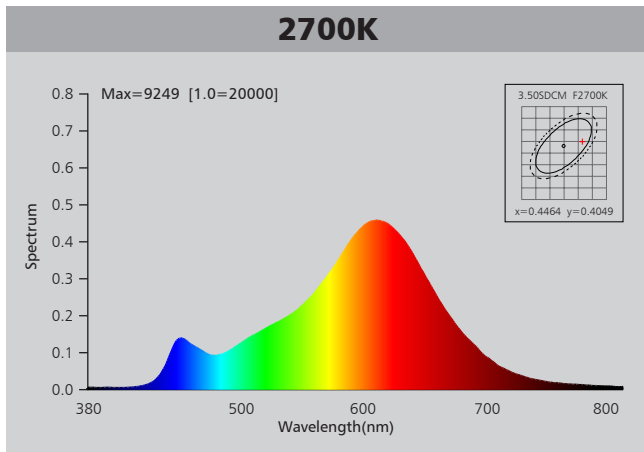

Photometric Diagram

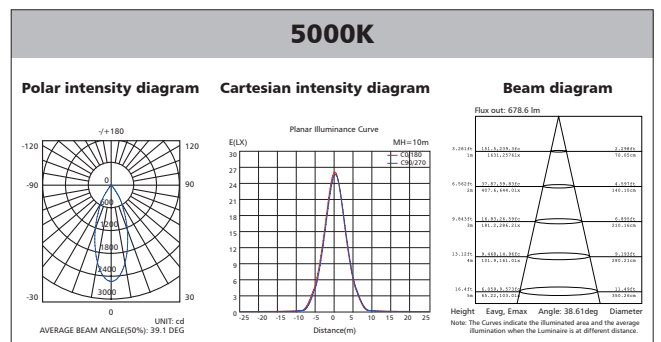
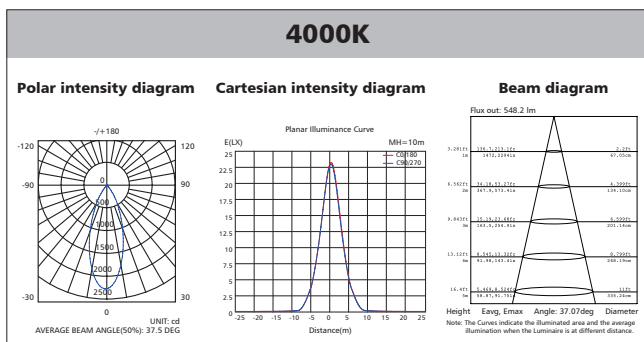
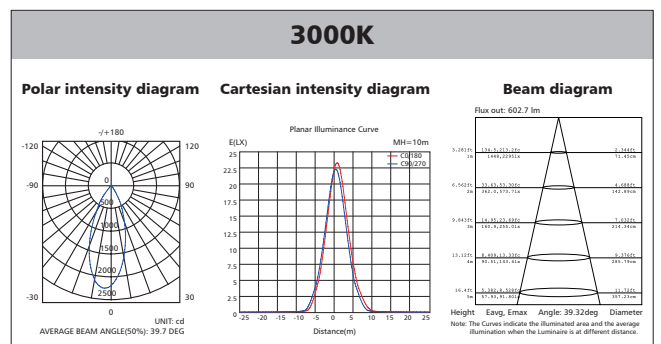
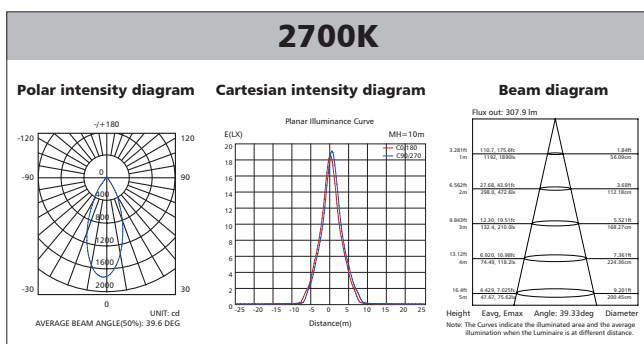

Polar Diagram Comparison

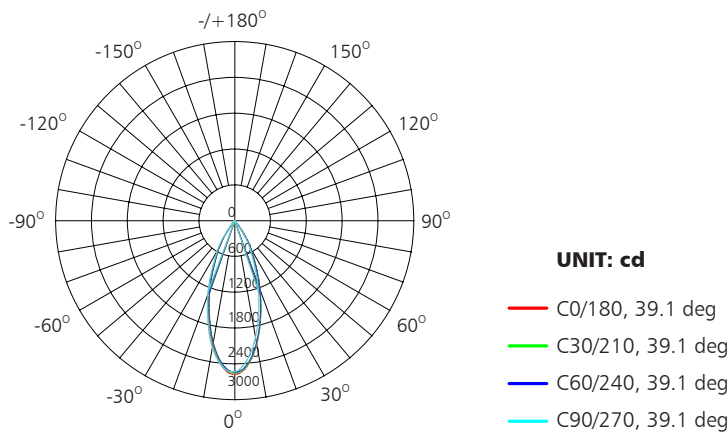

AVERAGE BEAM ANGLE (50%): 37.1DEG



Driver lifetime & LED light decay rate

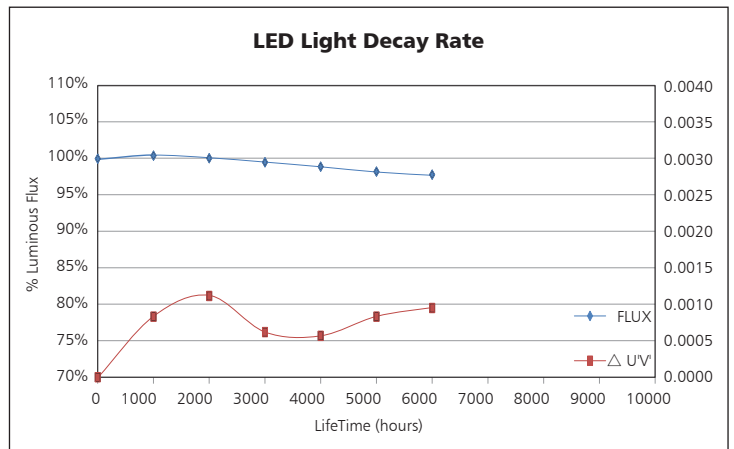
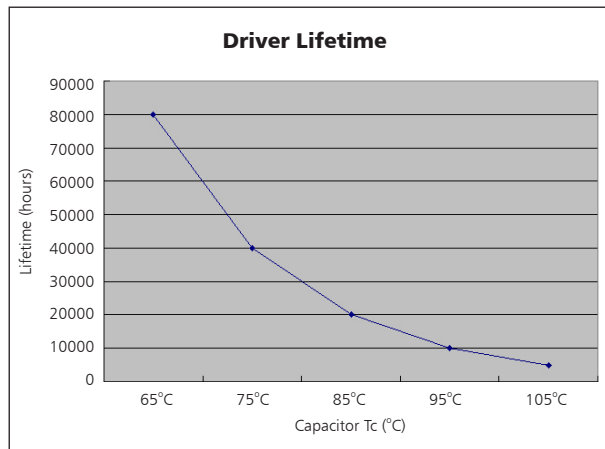

Temperature

- The testing is operated at 25°C
- The lifetime of capacitor, minimum of 5,000 hours if operated at 105°C, will be doubled whenever the temperature drops 10°C
- The highest withstand temperature of IC, MOS could be 120°C
- The highest withstand temperature of LED junction temperature is 150°C

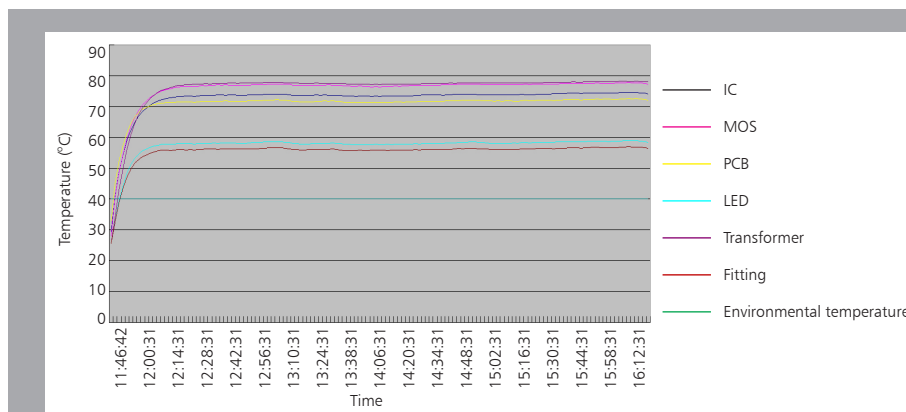

The driver lifespan is based on capacitor working temperature.

Installation

Install requirements	
A-gap above the fitting	25mm
B-gap to the building material	25mm
C-gap to the thermal insulation	25mm

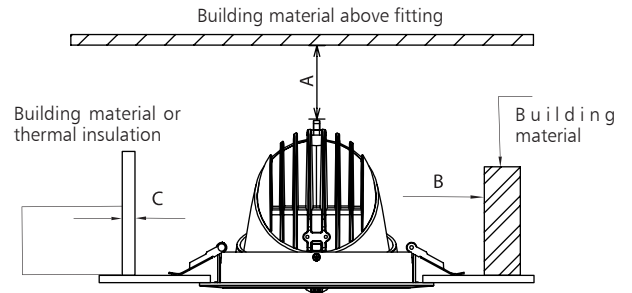

<p>Ceiling Opening</p> <p style="text-align: right;">1</p>	<p>Connect Power supply</p> <p style="text-align: right;">2</p>
<p>A. Hold back spring clips</p> <p>B. Push downlight into position</p> <p style="text-align: right;">3</p>	<p>Finish</p> <p style="text-align: right;">4</p>

Packaging Information

	SIZE(CM)	N.W/pc (KGS)	G.W.(KGS)	Q'TY(PCS)
Carton	50*34*41	0.55	12.5	18

	CTNS	Q'TY(PCS)	VOLUME(CBM)
20" standard container	396	7128	28
40" standard container	792	14256	56

