



Up-shine[®] Lighting



Technical Application
Guide for UP-SHINE
LED Downlight

UP-DL65-2.5-7W

Introduction

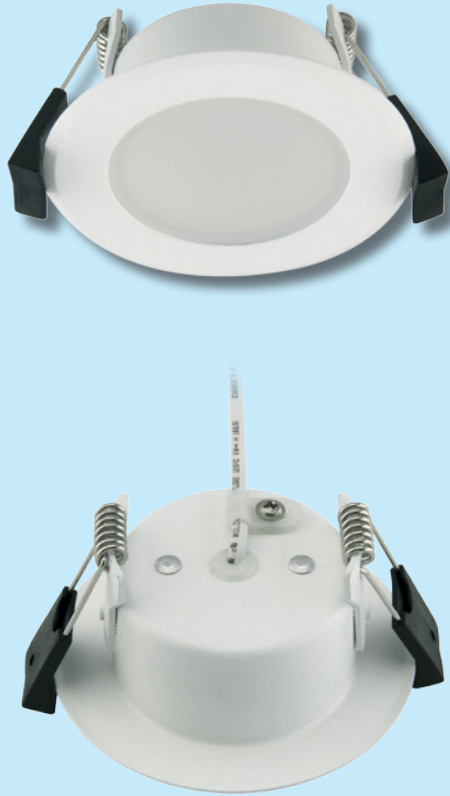

Up-shine downlight DL65 is unique designed for European and Oceania market. Aluminum profile provides excellent thermal dissipation. Fire-rated PC diffuser adopts even light output. With IP54 waterproof structural design, it is an ideal replacement for damp locations. Isolated driver solution both in dimmable and non-dimmable version, achieves great dimming compatibility with worldwide brand dimmers.

- Up to 70% energy saving compared to standard CFL
- Long lifetime of 40,000 hours
- Dimmable when using triac dimmer
- 90° wide beam angle
- Ø70mm cutout
- CCT: 3000K 4000K
5000K 5700K
- No UV/IR light
- Environment friendly, without Mercury or any other hazardous substances

Application notes

- IP54 for indoor use only
- Professional electrician for installation only
- Switch off before installation
- Do not touch when in use
- Keep away from hot steam and corrosive gas

Application Areas

It is designed for general lighting applications in office, supermarket, shop, school, hotel, etc. It is also widely used for public areas, such as stairway, lobby, reception, corridors etc.

Certificate



Product Information

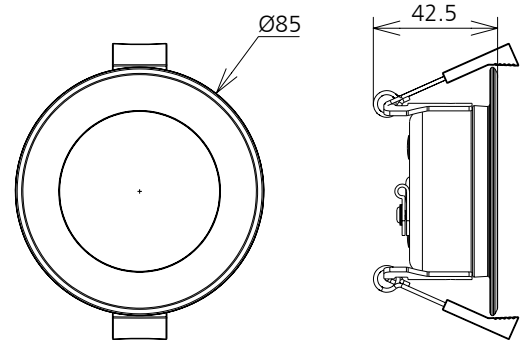

Technical Specifications

Model	Voltage	Power	Power Factor	Lumen (±5%)	Beam angle	CCT	Lifespan	CRI	Dimmable	Dimension
UP-DL65-2.5-7W	AC230V	7W	≥0.9	460	90°	3000K	40000h	≥80	No	Ø85*42.5mm cutout 70mm
UP-DL65-2.5-7W	AC230V	7W	≥0.9	500	90°	4000K	40000h	≥80	No	Ø85*42.5mm cutout 70mm
UP-DL65-2.5-7W	AC230V	7W	≥0.9	510	90°	5000K	40000h	≥80	No	Ø85*42.5mm cutout 70mm
UP-DL65-2.5-7W	AC230V	7W	≥0.9	500	90°	5700K	40000h	≥80	No	Ø85*42.5mm cutout 70mm
UP-DL65-2.5-7W-D	AC230V	7W	≥0.9	430	90°	3000K	40000h	≥80	Yes	Ø85*42.5mm cutout 70mm
UP-DL65-2.5-7W-D	AC230V	7W	≥0.9	460	90°	4000K	40000h	≥80	Yes	Ø85*42.5mm cutout 70mm
UP-DL65-2.5-7W-D	AC230V	7W	≥0.9	470	90°	5000K	40000h	≥80	Yes	Ø85*42.5mm cutout 70mm
UP-DL65-2.5-7W-D	AC230V	7W	≥0.9	450	90°	5700K	40000h	≥80	Yes	Ø85*42.5mm cutout 70mm

Driver data Sheet

Driver data	DIM	Non-dim
Input rated Voltage	AC230V	AC230V
Frequency	50HZ	50HZ
Input Voltage	AC200-240V	AC200-240V
Efficiency	≥72%	≥82%
Total load Wattage	7W±0.5W	7W±0.5W
Power Factor	≥0.9	≥0.9
Rated input current	≤0.04A	≤0.04A
Full load output Voltage	DC20-23V	DC20-23V
Rated output current	230mA	260mA
Output current range	230mA±5%	260mA±5%
Power tolerance	±5%	±5%
Current output tolerance	±5%	±5%
Dimming range	8%-100%	—
Dimmer	Triac dimmers	—
Short circuit protection	PASS	PASS
Over voltage protection	PASS	PASS
Over temperature protection	PASS	PASS
Withstand voltage	AC3750V	AC3750V

Fixture Compatibility

Rated Wattage	Electrical Classification	Ingress Protection	Operating Temp	Operating Humidity	Storage Temp
7W	II	IP54	-20°C~45°C	0~90%	-20°C~65°C

Spectral Distribution

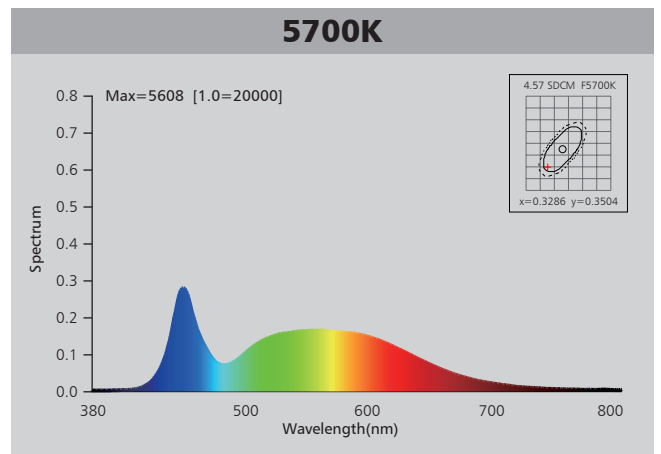
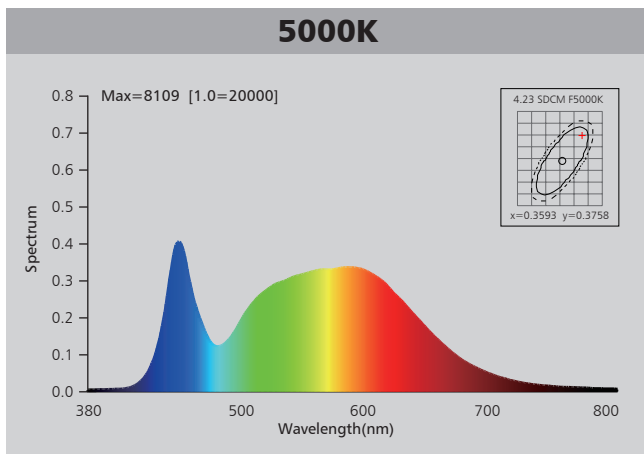
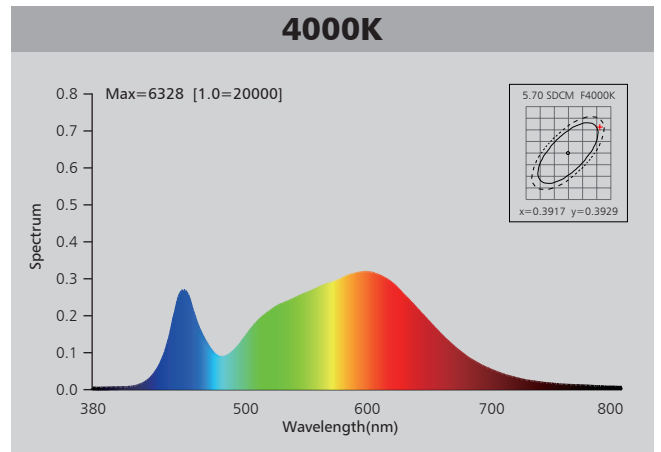
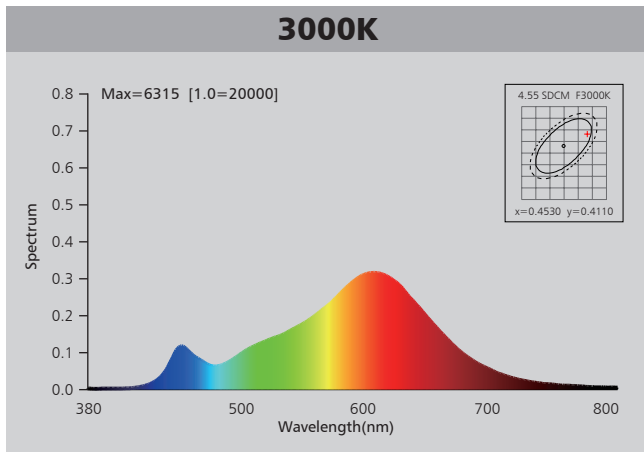

Photometric Diagram

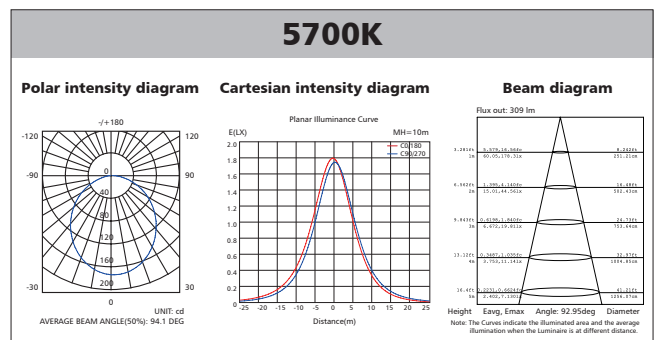
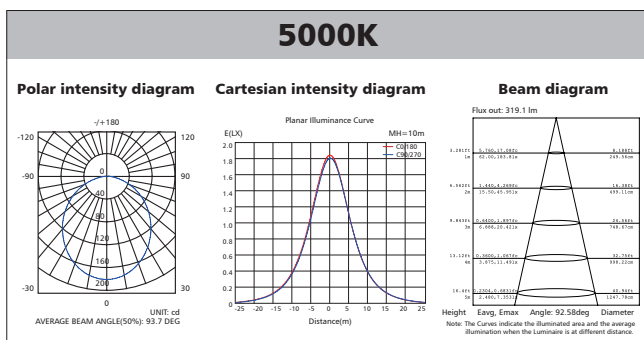
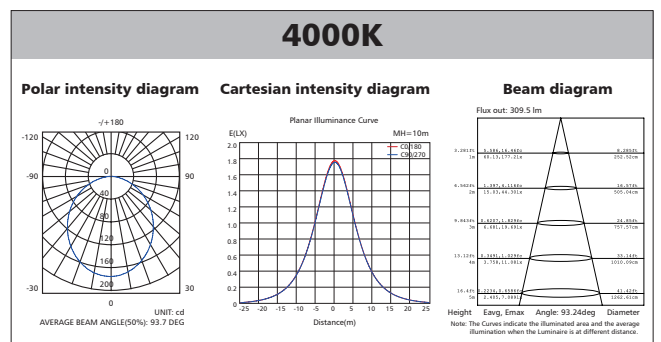
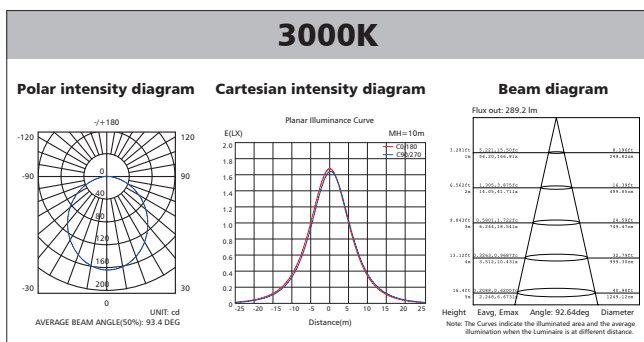

Polar Diagram Comparison

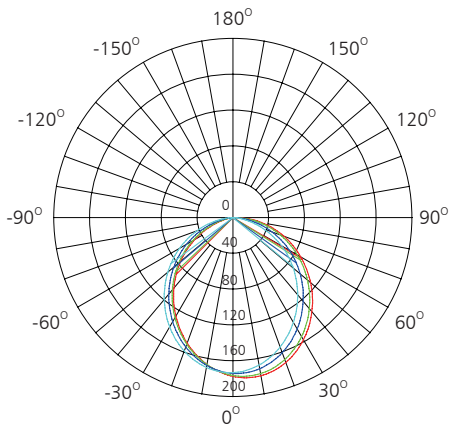

UNIT: cd

- C0/180, 94.1 deg
- C30/210, 94.2 deg
- C60/240, 94.1 deg
- C90/270, 94.0 deg



AVERAGE BEAM ANGLE (50%): 94.1DEG

Driver lifetime & LED light decay rate

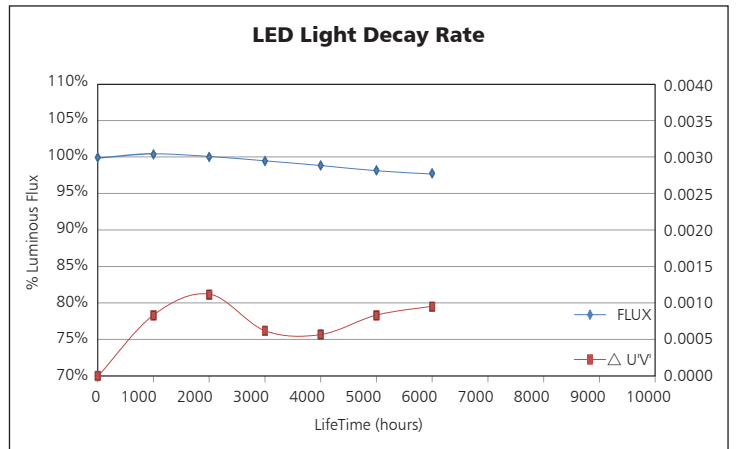
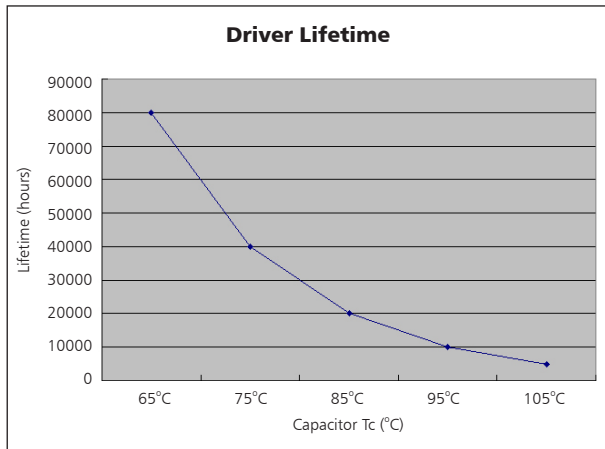

Temperature

- The testing is operated at 25°C
- The lifetime of capacitor, minimum of 5,000 hours if operated at 105°C, will be doubled whenever the temperature drops 10°C
- The highest withstand temperature of IC, MOS could be 120°C
- The highest withstand temperature of LED junction temperature is 150°C

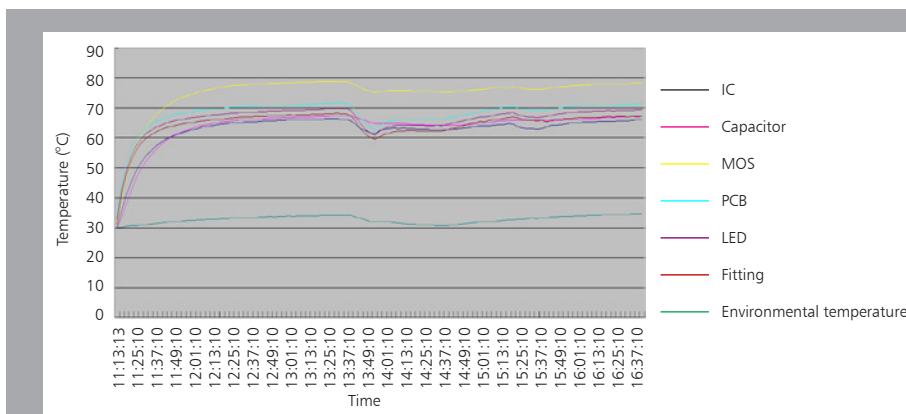

The driver lifespan is based on capacitor working temperature.

Installation

Install requirements	
A-gap above the fitting	25mm
B-gap to the building material	25mm
C-gap to the thermal insulation	25mm

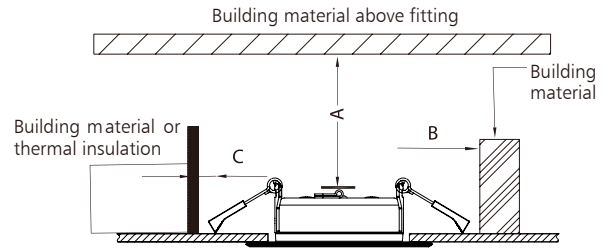

<p>Ceiling Opening</p> <p style="text-align: right;">1</p>	<p>Connect Power supply</p> <p style="text-align: right;">2</p>
<p>A. Hold back spring clips</p> <p>B. Push downlight into position</p> <p style="text-align: right;">3</p>	<p>Spring Clips</p> <p style="text-align: right;">4</p>

Packaging Information

	SIZE(CM)	N.W/pc (KGS)	G.W.(KGS)	Q'TY(PCS)
Carton	52.5*52.5*23	0.11	7.5	50

	CTNS	Q'TY(PCS)	VOLUME(CBM)
20" standard container	434	21700	28
40" standard container	868	43400	56

