



Up-shine[®] Lighting



Technical Application
Guide for UP SHINE
LED Downlight

UP-DL54-3-10W

Introduction



SMD LED Down light adopts high lumen SMD LED, PC diffuser with even light output. V0 fire rated plastic housing with internal driver design; it is our most economical and practical downlight version. Dimmable version available, it shares great popularity by the excellent dimming effect.

- Up to 70% energy saving compared to standard CFL
- Long lifetime of 40,000 hours
- Dimmable when using triac dimmer
- 90° wide beam angle
- 90-95mm cutout
- CCT: 3000K 4000K
5000K 5700K
- No UV/IR light
- Environment friendly, without Mercury or any other hazardous substances

Application notes

- IP20 for indoor use only
- Professional electrician for installation only
- Switch off before installation
- Do not touch when in use
- Keep away from hot steam and corrosive gas

Application Areas

It is designed for general lighting applications in office, supermarket, shop, school, hotel, etc. It is also widely used for public areas, such as stairway, lobby, reception, corridors etc.

Certificate



RoHS



Product Information

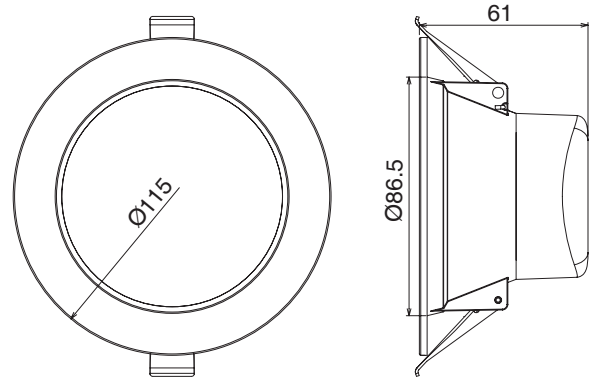

Technical Specifications

Model	Voltage	Power	Power Factor	Lumen (±5%)	Beam angle	CCT	Lifespan	CRI	Dimmable	Dimension
UP-DL54-3-10W	AC100-240V	10W	≥0.9	840	90°	3000K	40000h	≥80	No	Ø115*61mm cutout 90-95mm
UP-DL54-3-10W	AC100-240V	10W	≥0.9	920	90°	4000K	40000h	≥80	No	Ø115*61mm cutout 90-95mm
UP-DL54-3-10W	AC100-240V	10W	≥0.9	910	90°	5000K	40000h	≥80	No	Ø115*61mm cutout 90-95mm
UP-DL54-3-10W	AC100-240V	10W	≥0.9	900	90°	5700K	40000h	≥80	No	Ø115*61mm cutout 90-95mm
UP-DL54-3-10W-D	AC230V	10W	≥0.9	840	90°	3000K	40000h	≥80	Yes	Ø115*61mm cutout 90-95mm
UP-DL54-3-10W-D	AC230V	10W	≥0.9	920	90°	4000K	40000h	≥80	Yes	Ø115*61mm cutout 90-95mm
UP-DL54-3-10W-D	AC230V	10W	≥0.9	910	90°	5000K	40000h	≥80	Yes	Ø115*61mm cutout 90-95mm
UP-DL54-3-10W-D	AC230V	10W	≥0.9	900	90°	5700K	40000h	≥80	Yes	Ø115*61mm cutout 90-95mm

Driver data Sheet

Driver data	DIM	Non-DIM
Input rated Voltage	AC230V	AC100-240V
Frequency	50Hz	50/60Hz
Input Voltage	AC200-240V	AC85-265V
Efficiency	≥83%	≥84%
Total load Wattage	10W±1W	10W±1W
Power Factor	≥0.9	≥0.9
Rated input current	≤0.06A	≤0.12A
Full load output Voltage	35-38V	35-38V
Rated output current	230mA	230mA
Output current range	230mA±5%	230mA±5%
Power tolerance	±5%	±5%
Current output tolerance	±5%	±5%
Dimming range	10%-100%	—
Dimmer	Triac dimmers	—
Withstand voltage	AC3750V	AC3750V
Short circuit protection	PASS	PASS
Over voltage protection	PASS	PASS
Over temperature protection	PASS	PASS

Fixture Compatibility

Rated Wattage	Electrical Classification	Ingress Protection	Operating Temp	Operating Humidity	Storage Temp
10W	II	IP20	-20°C~45°C	0~90%	-20°C~65°C

Spectral Distribution

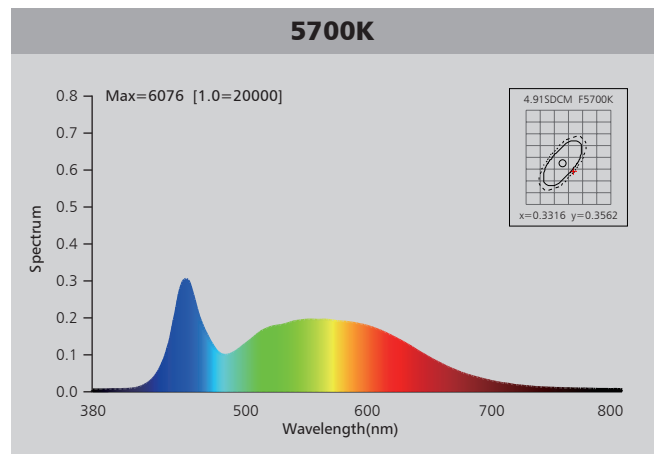
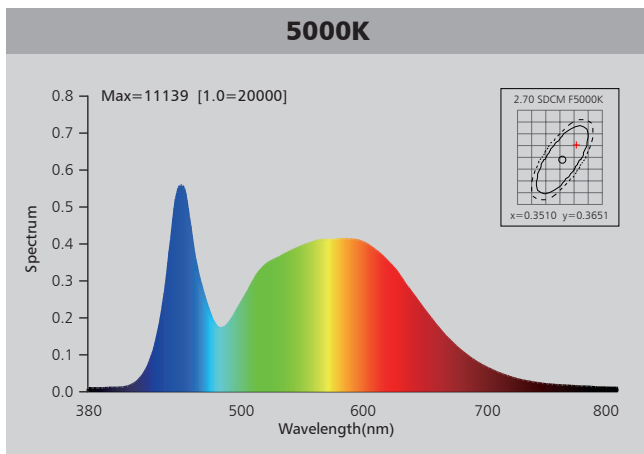
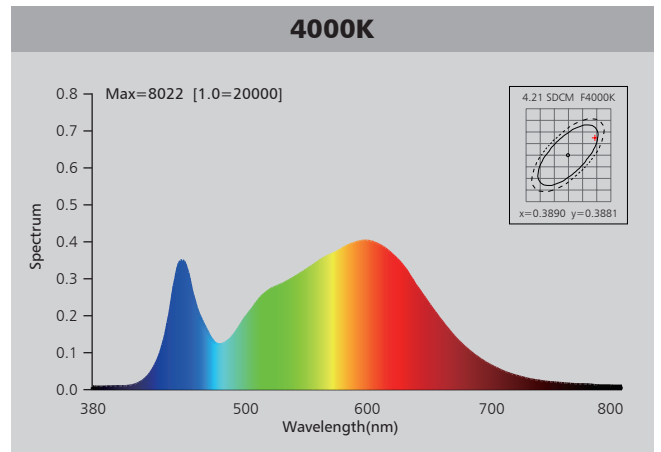
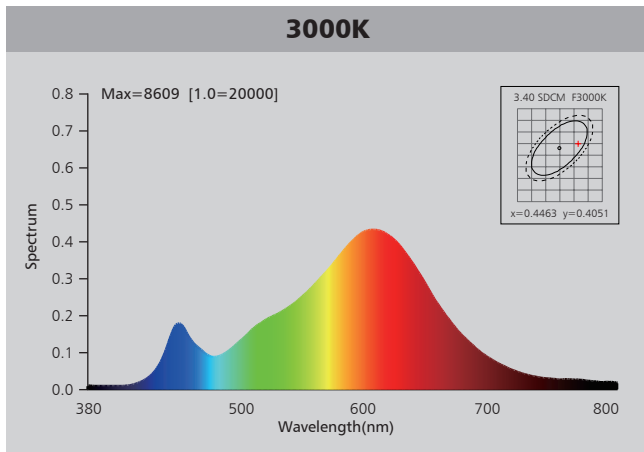

Photometric Diagram

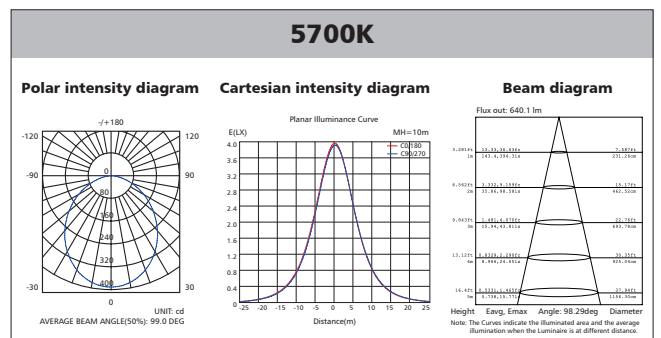
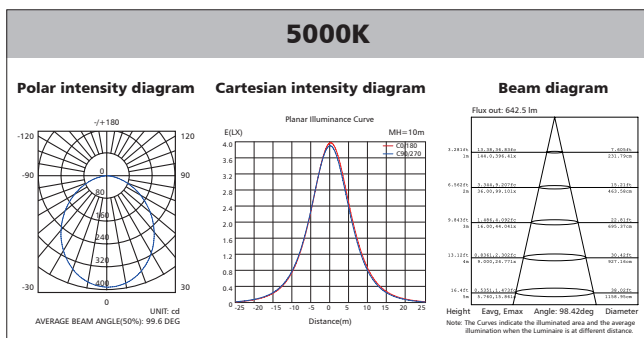
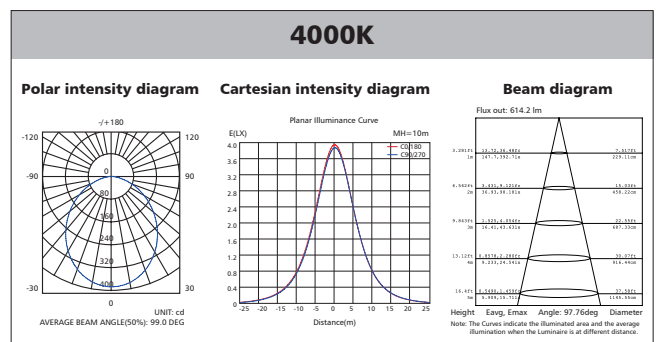
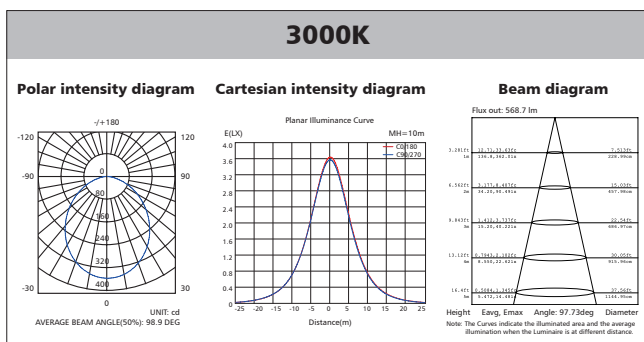

Polar Diagram Comparison

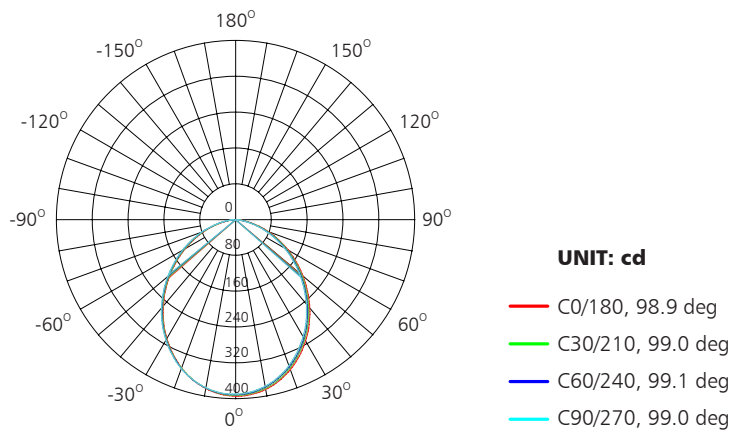

AVERAGE BEAM ANGLE (50%): 99.0DEG



Driver lifetime & LED light decay rate

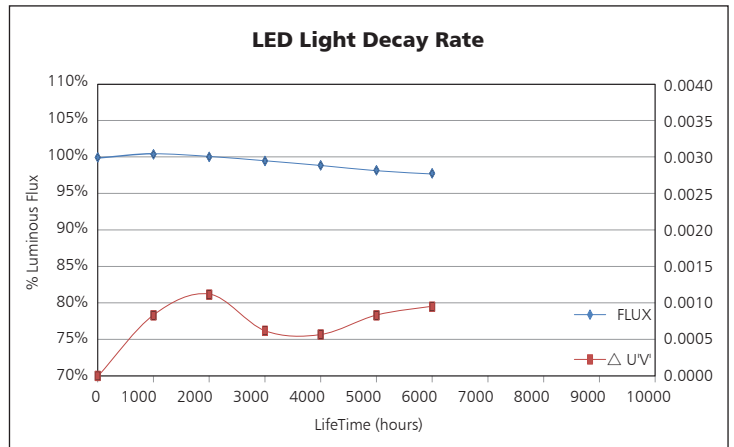
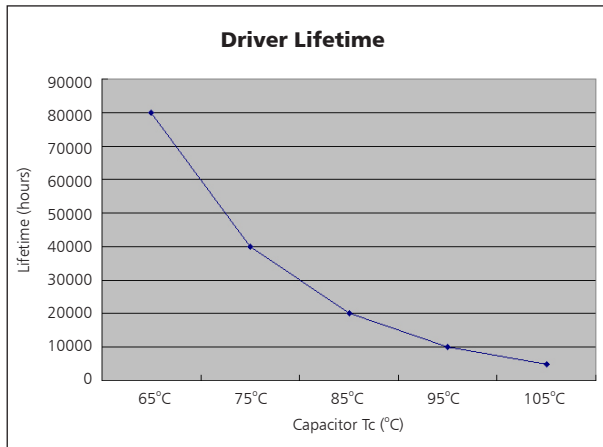

Temperature

- The testing is operated at 25°C
- The lifetime of capacitor, minimum of 5,000 hours if operated at 105°C, will be doubled whenever the temperature drops 10°C
- The highest withstand temperature of IC, MOS could be 120°C
- The highest withstand temperature of LED junction temperature is 150°C

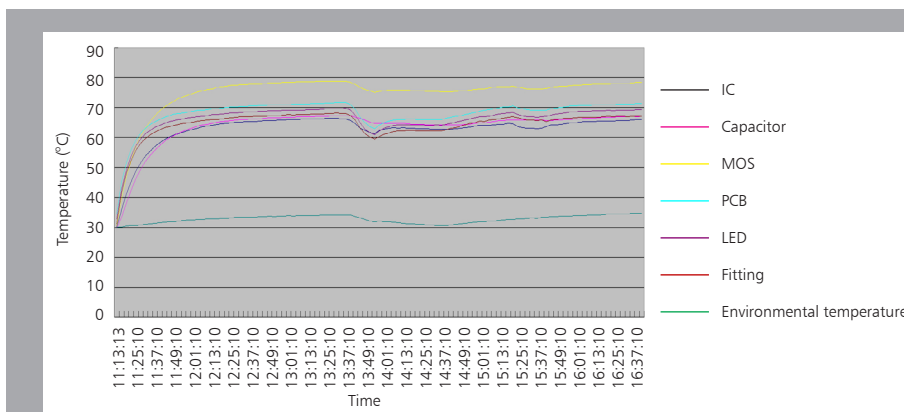

The driver lifespan is based on capacitor working temperature.

Installation

Install requirements	
A-gap above the fitting	25mm
B-gap to the building material	25mm
C-gap to the thermal insulation	25mm

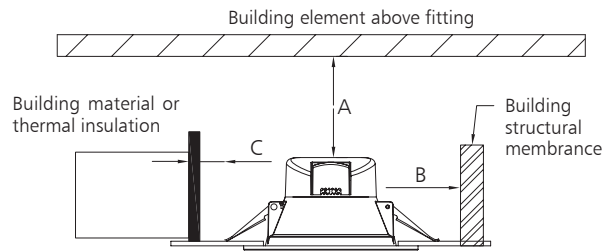

<p>Ceiling Opening</p> <p style="text-align: right;">1</p>	<p>Connect Power supply</p> <p style="text-align: right;">2</p>
<p>A. Hold back spring clips</p> <p>B. Push downlight into position</p> <p style="text-align: right;">3</p>	<p>Spring Clips</p> <p style="text-align: right;">4</p>

Packaging Information

	SIZE(CM)	N.W/pc (KGS)	G.W.(KGS)	Q'TY(PCS)
Carton	39*26.5*37.5	0.25	7.5	30

	CTNS	Q'TY(PCS)	VOLUME(CBM)
20" standard container	704	21120	28
40" standard container	1408	42240	56

