



UPSHINE®



Technical Application
Guide for UP-SHINE
LED Downlight
UP-DL41-3-8W-D

Introduction



Up-shine SMD LED Down light adopts high lumen SMD LED, PC diffuser with even light output. Plastic coated aluminum housing with internal driver design; it is our most economical and practical downlight version. Dimmable driver shares great popularity by the excellent dimming effect.

- Up to 70% energy saving compared to standard CFL
- Long lifetime of 40,000 hours
- Dimmable when using triac dimmer
- 90° wide beam angle
- 90-95mm cutout
- CCT: 3000K 4000K
5000K 5700K
- No UV/IR light
- Environment friendly, without Mercury or any other hazardous substances

Application notes

- IP54 only for the LED cover, IP40 for other part
- Professional electrician for installation only
- Switch off before installation
- Do not touch when in use
- Keep away from hot steam and corrosive gas

Application Areas

It is designed for general lighting applications in office, supermarket, shop, school, hotel, etc. It is also widely used for public areas, such as stairway, lobby, reception, corridors etc.

Certificate

CE RoHS SAA

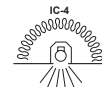

Product Information

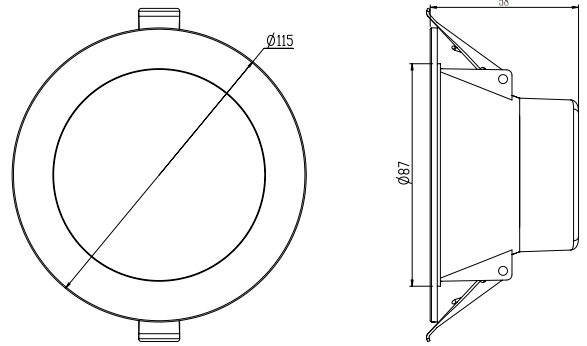

Technical Specifications

Model	Voltage	Power	Power Factor	Lumen (±5%)	Beam angle	CCT	Lifespan	CRI	Dimmable	Dimension
UP-DL41-3-8W-D	AC230V	8W	0.9	700	90°	3000K	40000h	≥80	Yes	Ø115*58mm cutout 90-95mm
UP-DL41-3-8W-D	AC230V	8W	0.9	750	90°	4000K	40000h	≥80	Yes	Ø115*58mm cutout 90-95mm
UP-DL41-3-8W-D	AC230V	8W	0.9	730	90°	5000K	40000h	≥80	Yes	Ø115*58mm cutout 90-95mm
UP-DL41-3-8W-D	AC230V	8W	0.9	730	90°	5700K	40000h	≥80	Yes	Ø115*58mm cutout 90-95mm

Driver data Sheet

Driver data	DIM
Input rated Voltage	AC230V
Frequency	50Hz
Input Voltage	AC220-240V
Efficiency	≥78%
Total load Wattage	8W±0.5W
Power Factor	0.9
Rated input current	≤0.043A
Full load output Voltage	55-65V
Rated output current	110mA
Output current range	110mA±5%
Power tolerance	±5%
Current output tolerance	±5%
Dimming range	8%-100%
Dimmer	Triac dimmers
Withstand voltage	—
Short circuit protection	PASS
Over voltage protection	PASS
Over temperature protection	PASS

Fixture Compatibility

Rated Wattage	Electrical Classification	Ingress Protection	Operating Temp	Operating Humidity	Storage Temp
8W	II	IP40 / IP54	-20°C~45°C	0~90%	-20°C~65°C

Spectral Distribution

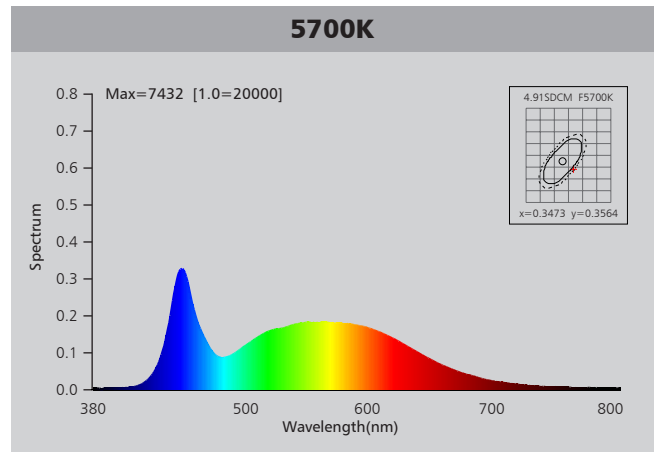
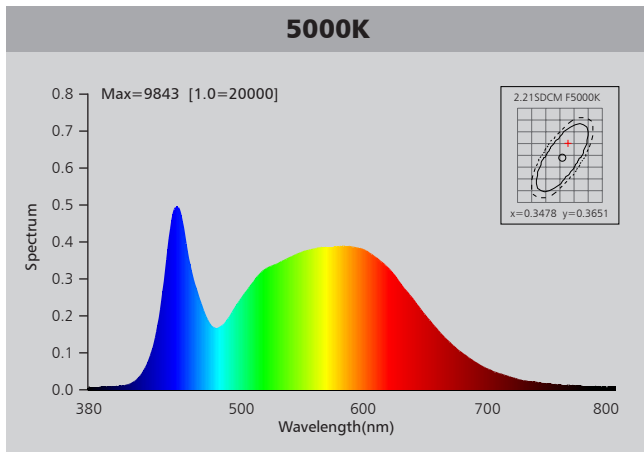
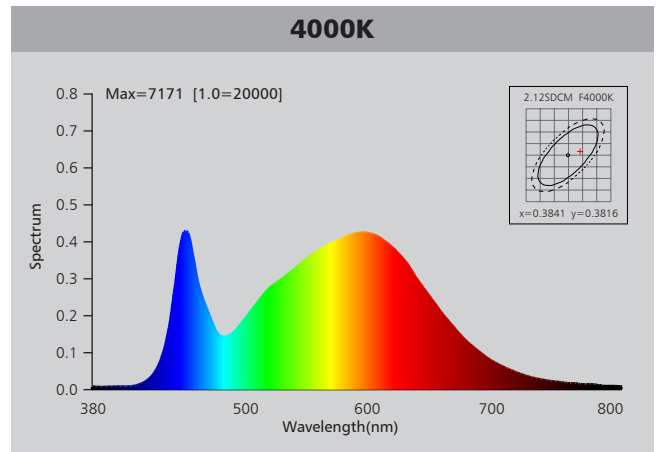
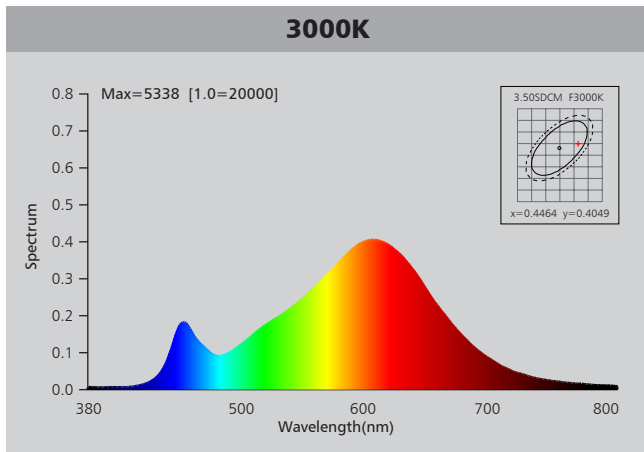

Photometric Diagram

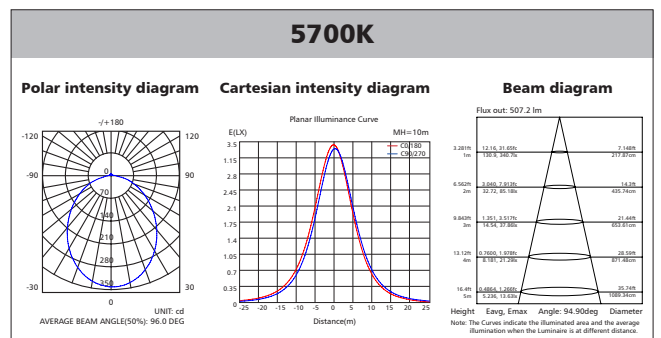
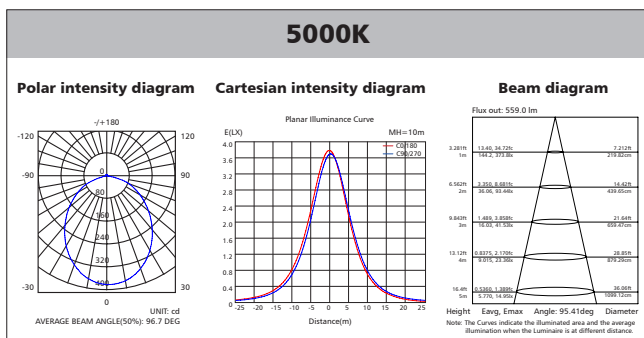
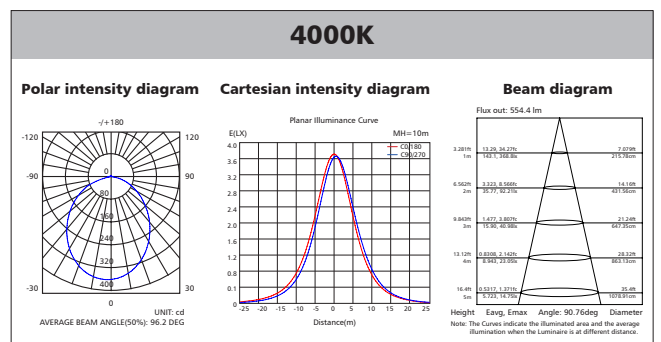
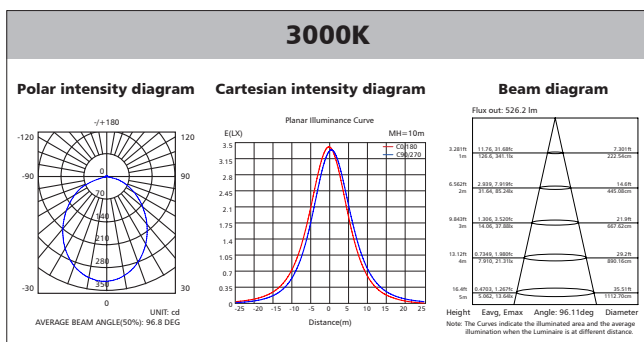

Polar Diagram Comparison

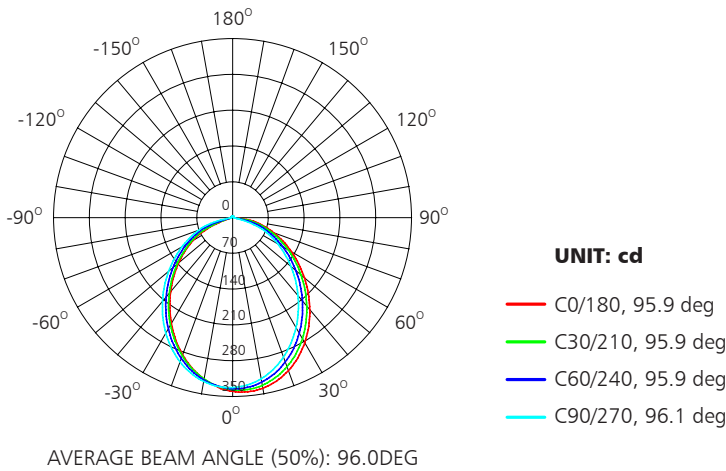

Driver lifetime & LED light decay rate

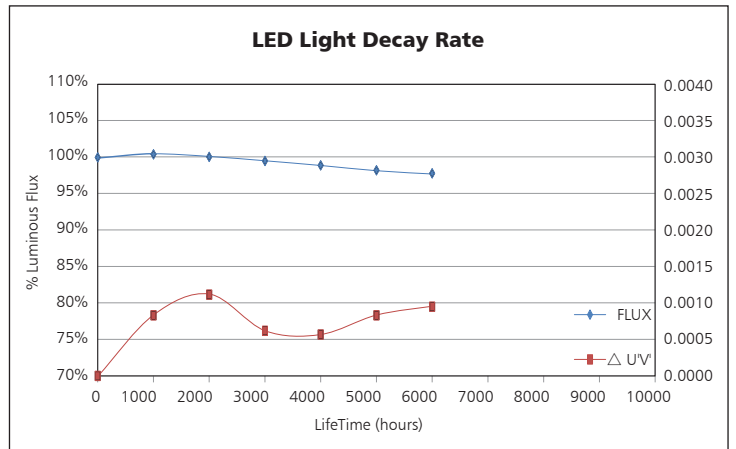
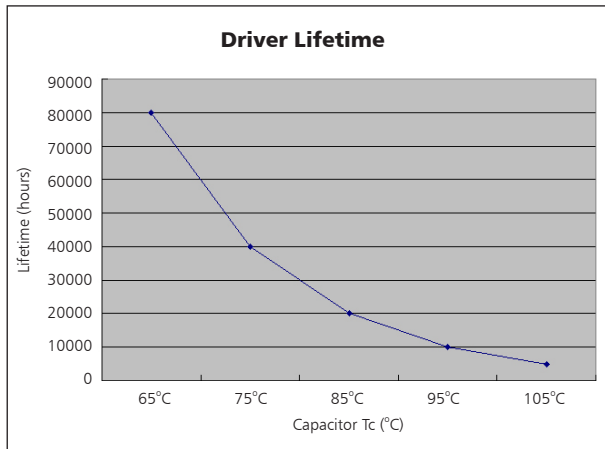

Temperature

- The testing is operated at 25°C
- The lifetime of capacitor, minimum of 5,000 hours if operated at 105°C, will be doubled whenever the temperature drops 10°C
- The highest withstand temperature of IC, MOS could be 120°C
- The highest withstand temperature of LED junction temperature is 150°C

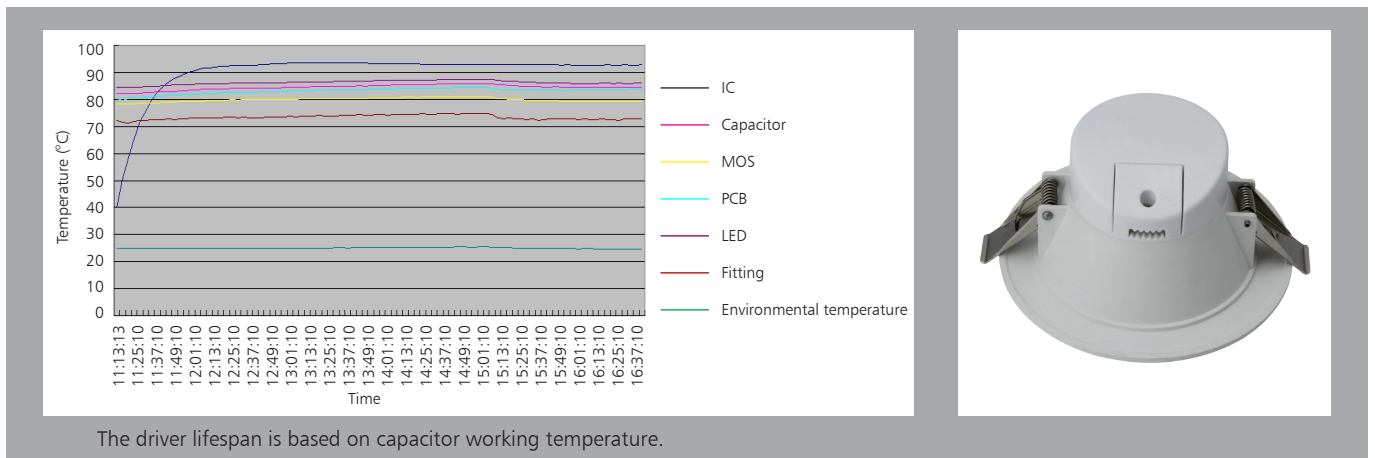

Installation

Install requirements	
HCB	25mm
SCB	25mm

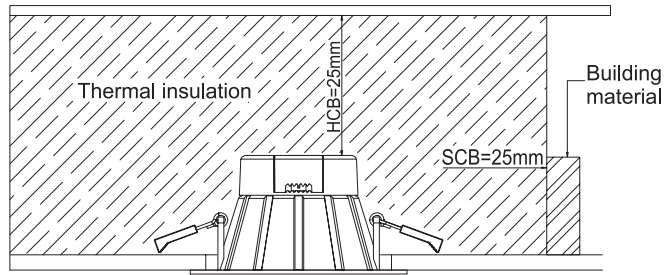

<p>Ceiling Opening</p> <p style="text-align: right;">1</p>	<p>Loosen the screw and take off the cover, connect the wire to the wiring terminals, put the cover back and tighten the screw.</p> <p style="text-align: right;">2</p>
<p>A. Hold back spring clips</p> <p>B. Push downlight into position</p> <p style="text-align: right;">3</p>	<p>Spring Clips</p> <p>Ceiling</p> <p style="text-align: right;">4</p>

Packaging Information

	SIZE(CM)	N.W/pc (KGS)	G.W.(KGS)	Q'TY(PCS)
Carton	39*26.5*37.5	0.25	9	30

	CTNS	Q'TY(PCS)	VOLUME(CBM)
20" standard container	704	21120	28
40" standard container	1408	42240	56

