



Up-shine[®] Lighting



Technical Application
Guide for UP SHINE
LED Downlight
UP-CL77-3-10W

Introduction

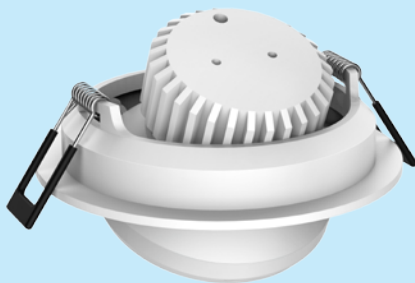

↻ 360°

↻ 25°



Up-shine patent mini downlight is special designed for European market, adopts high lumen COB LED. The reflector is made of high-reflectivity PC material; it creates high lumen output, with light transmittance up to 90%. Aluminum housing provides excellent thermal dissipation. Adjustable lighting direction provides all possible lighting effect. 360 degree rotate horizontally and 25 degree rotate vertically. Isolated driver solution both in dimmable and non-dimmable, dimmable version achieves great dimming compatibility with worldwide brand dimmers.

- Up to 70% energy saving compared to standard CFL
- Long lifetime of 40,000 hours
- Triac dim
- 15° / 24° / 36° / 60° wide beam angle
- Ø85-90mm cutout
- CCT: 2700K 3000K
4000K 5000K
- No UV/IR light
- Environment friendly, without Mercury or any other hazardous substances

Application notes

- IP40 for indoor use only
- Professional electrician for installation only
- Switch off before installation
- Do not touch when in use
- Keep away from hot steam and corrosive gas

Application Areas

It is designed for general lighting applications in home, office, shop, school, hotel, etc. It is also widely used for public areas, such as gallery, lobby, reception, corridors etc.

Certificate



RoHS



Product Information

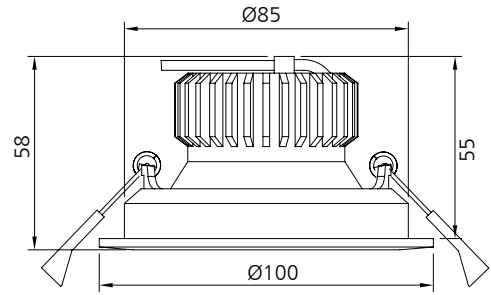

Technical Specifications

Model	Voltage	Power	Power Factor	Lumen (±5%)	Beam angle	CCT	Lifespan	CRI	Dimmable	Dimension
UP-CL77-3-10W	AC230V	10W	≥0.9	650	15° / 24° 36° / 60°	2700K	40000h	≥80	No	Ø100*58mm cutout Ø85-90mm
UP-CL77-3-10W	AC230V	10W	≥0.9	720	15° / 24° 36° / 60°	3000K	40000h	≥80	No	Ø100*58mm cutout Ø85-90mm
UP-CL77-3-10W	AC230V	10W	≥0.9	750	15° / 24° 36° / 60°	4000K	40000h	≥80	No	Ø100*58mm cutout Ø85-90mm
UP-CL77-3-10W	AC230V	10W	≥0.9	770	15° / 24° 36° / 60°	5000K	40000h	≥80	No	Ø100*58mm cutout Ø85-90mm
UP-CL77-3-10W-D	AC230V	10W	≥0.9	610	15° / 24° 36° / 60°	2700K	40000h	≥80	Yes	Ø100*58mm cutout Ø85-90mm
UP-CL77-3-10W-D	AC230V	10W	≥0.9	650	15° / 24° 36° / 60°	3000K	40000h	≥80	Yes	Ø100*58mm cutout Ø85-90mm
UP-CL77-3-10W-D	AC230V	10W	≥0.9	700	15° / 24° 36° / 60°	4000K	40000h	≥80	Yes	Ø100*58mm cutout Ø85-90mm
UP-CL77-3-10W-D	AC230V	10W	≥0.9	720	15° / 24° 36° / 60°	5000K	40000h	≥80	Yes	Ø100*58mm cutout Ø85-90mm

Driver data Sheet

Driver data	DIM	Non dim
Input rated Voltage	AC230V	AC230V
Frequency	50Hz	50Hz
Input Voltage	AC200-240V	AC200-240V
Efficiency	≥75%	≥83%
Total load Wattage	10W±1W	10W±1W
Power Factor	≥0.9	≥0.9
Rated input current	≤0.045A	≤0.05A
Full load output Voltage	DC35-38V	DC35-38V
Rated output current	220mA	230mA
Output current range	220mA±5%	230mA±5%
Power tolerance	±5%	±5%
Current output tolerance	±5%	±5%
Dimming range	8%-100%	——
Dimmer	Triac dimmers	——
Short circuit protection	PASS	PASS
Over voltage protection	PASS	PASS
Over temperature protection	PASS	PASS
Withstand voltage	AC3750V	AC3750V

Fixture Compatibility

Rated Wattage	Electrical Classification	Ingress Protection	Operating Temp	Operating Humidity	Storage Temp
10W	II	IP40	-20°C~45°C	0~90%	-20°C~65°C

Spectral Distribution

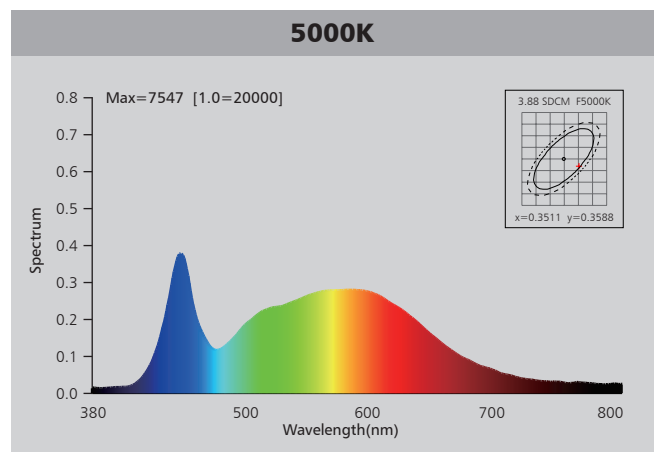
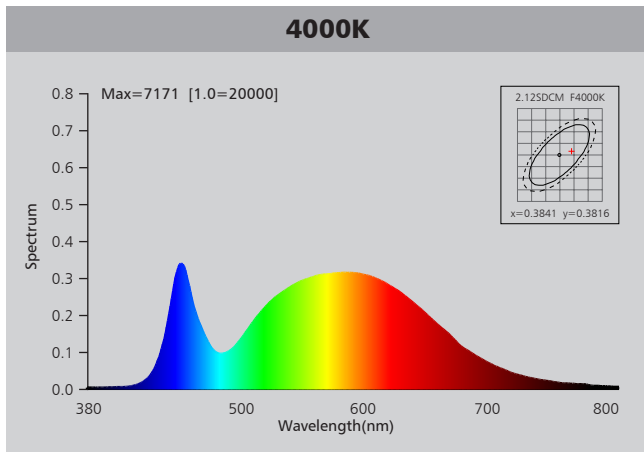
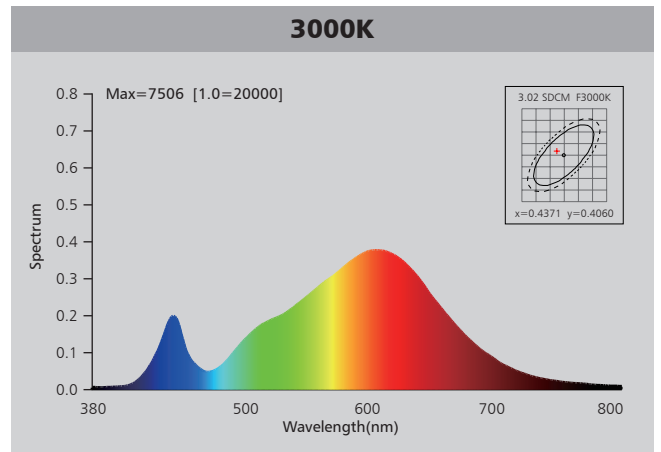
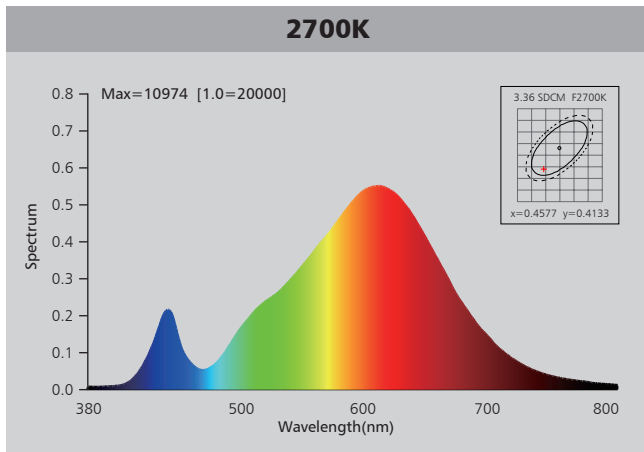

Photometric Diagram

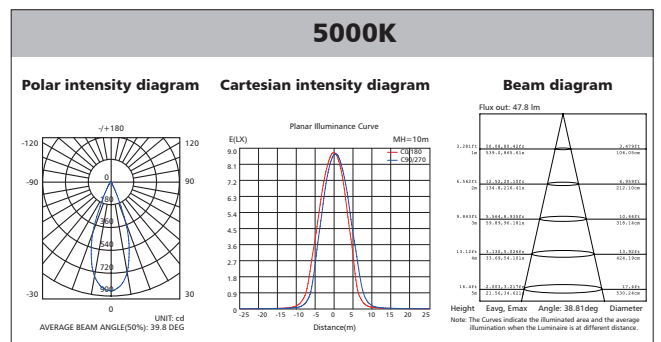
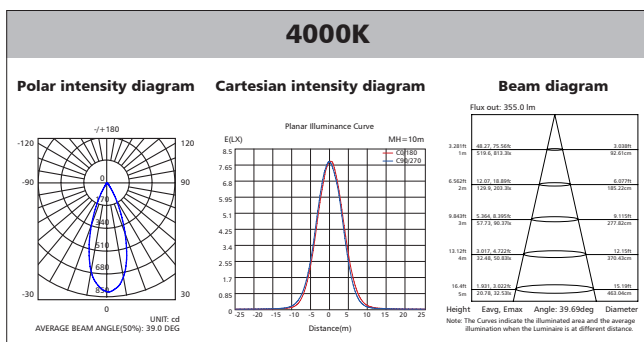
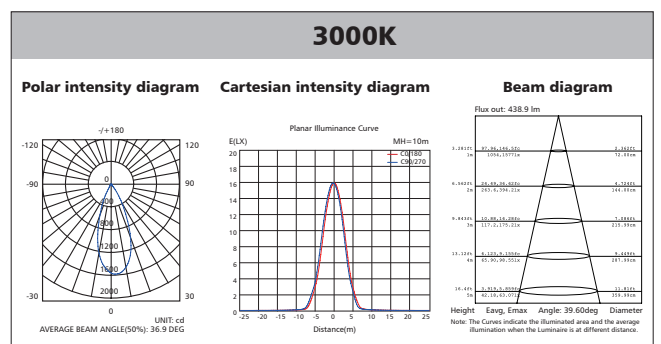
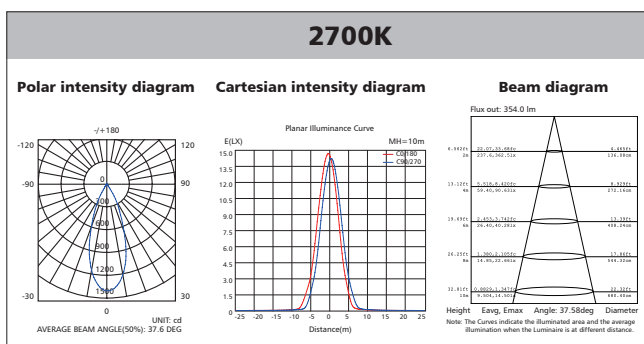

Polar Diagram Comparison

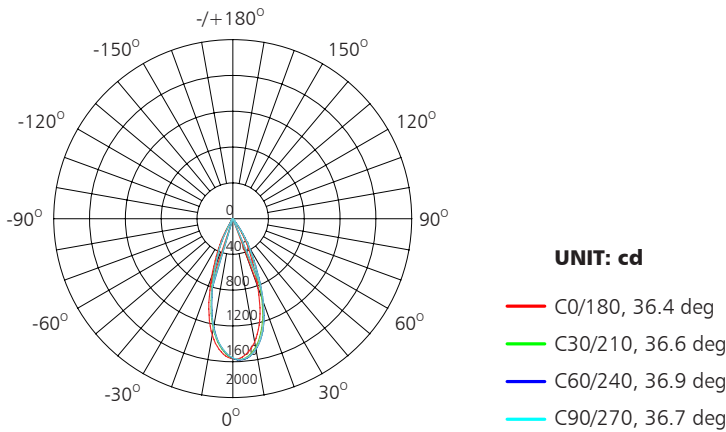

AVERAGE BEAM ANGLE (50%): 36.9DEG

Driver lifetime & LED light decay rate

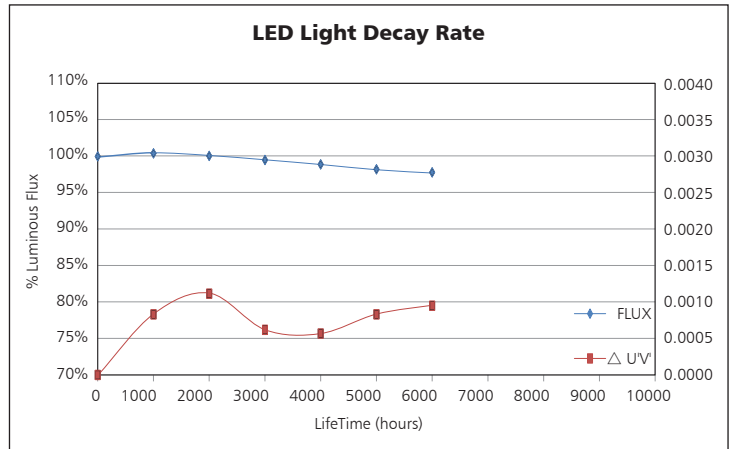
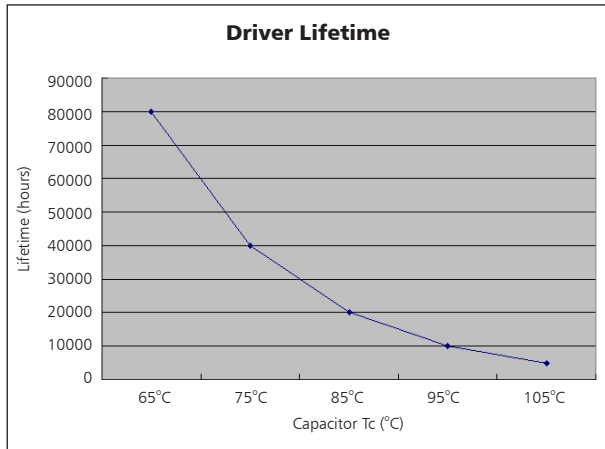

Temperature

- The testing is operated at 25°C
- The lifetime of capacitor, minimum of 5,000 hours if operated at 105°C, will be doubled whenever the temperature drops 10°C
- The highest withstand temperature of IC, MOS could be 120°C
- The highest withstand temperature of LED junction temperature is 150°C

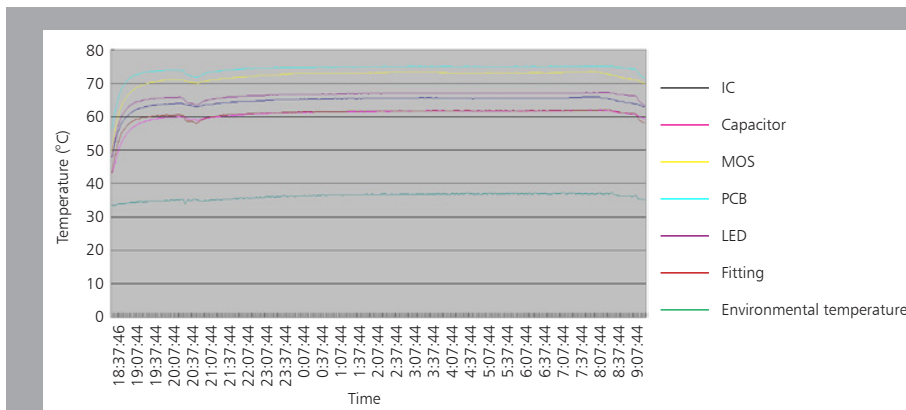

The driver lifespan is based on capacitor working temperature.

Installation

Install requirements	
A-gap above the fitting	25mm
B-gap to the building material	25mm
C-gap to the thermal insulation	25mm

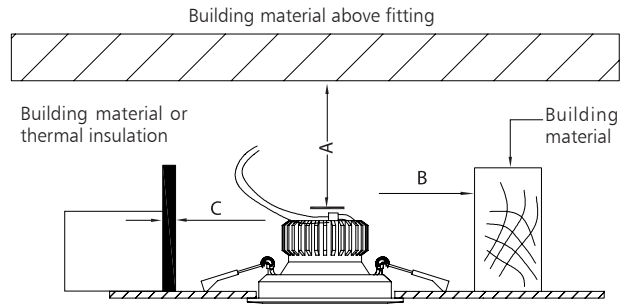

Ceiling Opening

1

Connect Power supply

2

A. Hold back spring clips

3

B. Push downlight into position

Finish

4

Packaging Information

	SIZE(CM)	N.W/pc (KGS)	G.W.(KGS)	Q'TY(PCS)
Carton	46*46*29.5	0.34	17	48

	CTNS	Q'TY(PCS)	VOLUME(CBM)
20" standard container	440	21120	28
40" standard container	880	42240	56

