



# Technical Application Guide for UP-SHINE LED Downlight

UP-CL59-5-18W

# Introduction



Up-shine SMD LED Down light adopts high lumen SMD LED, PMMA diffuser with even light output. White, silver, chrome surface treatments are available for wide choice. Triac dimmable, 0-10V dimmable and DALI dimmable version share great popularity by excellent dimming effect.

- Up to 70% energy saving compared to standard CFL
- Long lifetime of 40,000 hours
- Triac dim, 0-10V dim, DALI dim
- 90° wide beam angle
- 140-150mm cutout
- CCT: 3000K 4000K  
5000K 5700K
- No UV/IR light
- Environment friendly, without Mercury or any other hazardous substances

## Application notes

- IP20/IP44 for indoor use only
- Professional electrician for installation only
- Switch off before installation
- Do not touch when in use
- Keep away from hot steam and corrosive gas

## Application Areas

It is designed for general lighting applications in office, supermarket, shop, school, hotel, etc. It is also widely used for public areas, such as stairway, lobby, reception, corridors etc.

## Certificate



# Product Information

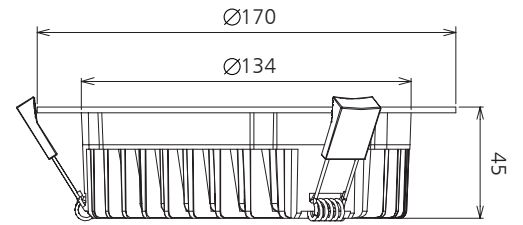

## Technical Specifications

Model	Voltage	Power	Power Factor	Lumen (±5%)	Beam angle	CCT	Lifespan	CRI	Dimmable	Dimension
UP-CL59-5-18W	AC100-240V	18W	≥0.9	1400	90°	3000K	40000h	≥80	No	Ø170*45mm cutout Ø140-150mm
UP-CL59-5-18W	AC100-240V	18W	≥0.9	1430	90°	4000K	40000h	≥80	No	Ø170*45mm cutout Ø140-150mm
UP-CL59-5-18W	AC100-240V	18W	≥0.9	1490	90°	5000K	40000h	≥80	No	Ø170*45mm cutout Ø140-150mm
UP-CL59-5-18W	AC100-240V	18W	≥0.9	1550	90°	5700K	40000h	≥80	No	Ø170*45mm cutout Ø140-150mm
UP-CL59-5-18W-D	AC230V	18W	≥0.9	1380	90°	3000K	40000h	≥80	Yes	Ø170*45mm cutout Ø140-150mm
UP-CL59-5-18W-D	AC230V	18W	≥0.9	1410	90°	4000K	40000h	≥80	Yes	Ø170*45mm cutout Ø140-150mm
UP-CL59-5-18W-D	AC230V	18W	≥0.9	1450	90°	5000K	40000h	≥80	Yes	Ø170*45mm cutout Ø140-150mm
UP-CL59-5-18W-D	AC230V	18W	≥0.9	1480	90°	5700K	40000h	≥80	Yes	Ø170*45mm cutout Ø140-150mm

## Driver data Sheet

Driver data	DIM	Non dim
Input rated Voltage	AC230V	AC100-240V
Frequency	50Hz	50/60Hz
Input Voltage	AC200-240V	AC85-265V
Efficiency	≥78%	≥86%
Total load Wattage	18W±1W	18W±1W
Power Factor	≥0.9	≥0.9
Rated input current	≤0.09A	≤0.2A
Full load output Voltage	DC29-33V	DC29-33V
Rated output current	450mA	500mA
Output current range	450mA±5%	500mA±5%
Power tolerance	±5%	±5%
Current output tolerance	±5%	±5%
Dimming range	8%-100%	——
Dimmer	Triac dimmers	——
Short circuit protection	PASS	PASS
Over voltage protection	PASS	PASS
Over temperature protection	PASS	PASS
Withstand voltage	AC3750V	AC3750V

## Fixture Compatibility

Rated Wattage	Electrical Classification	Ingress Protection	Operating Temp	Operating Humidity	Storage Temp
18W	II	IP20 / IP44	-20°C~45°C	0~90%	-20°C~65°C

# Spectral Distribution

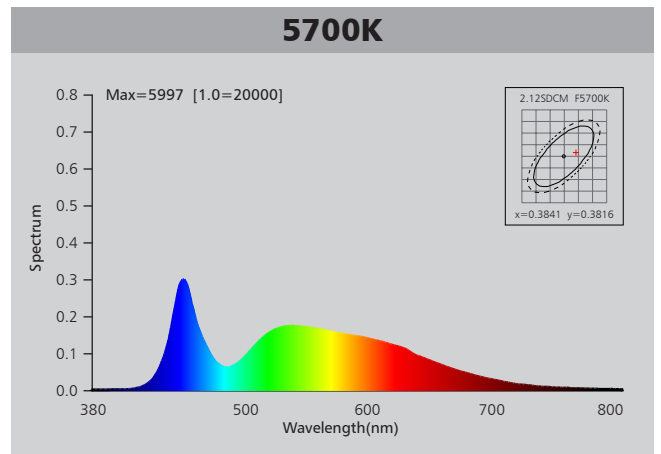
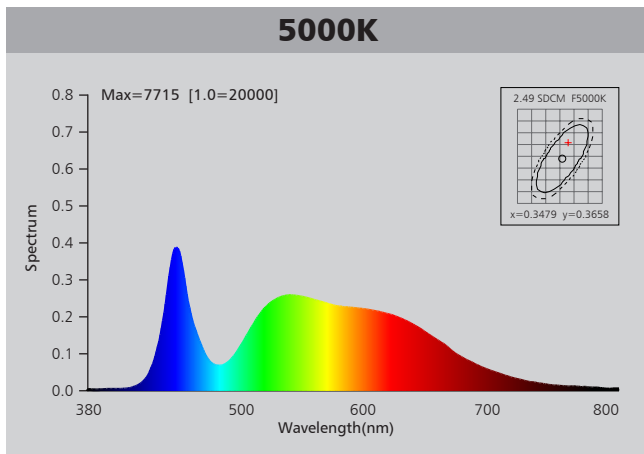
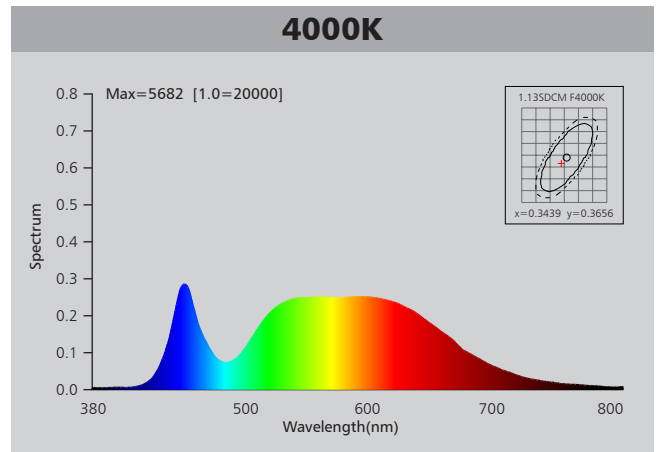
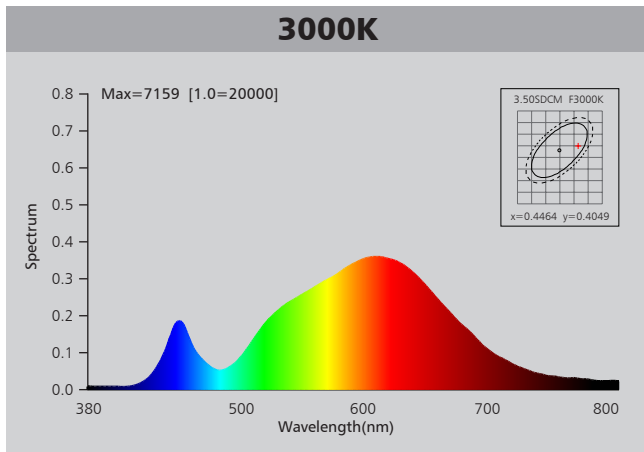

# Photometric Diagram

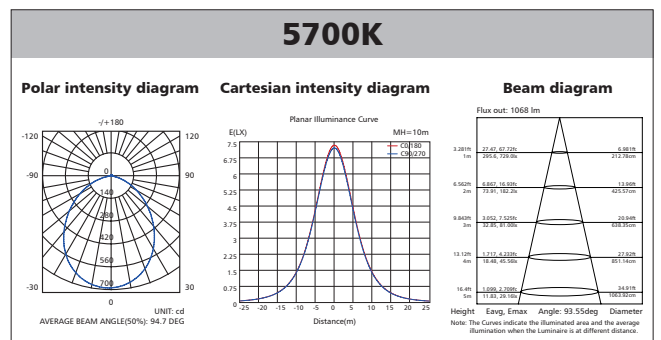
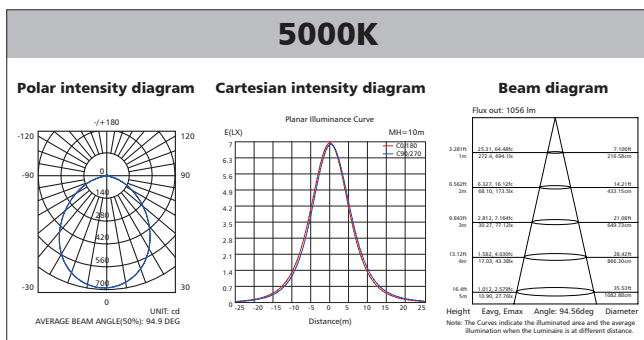
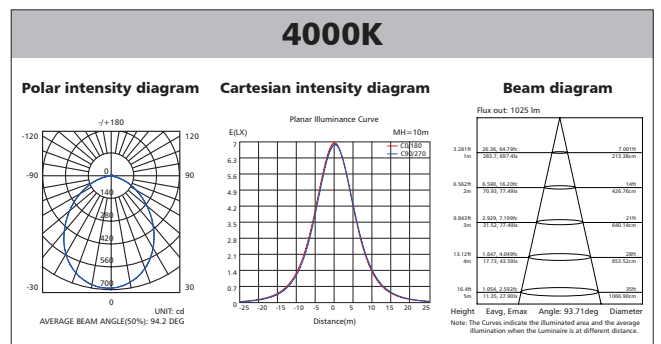
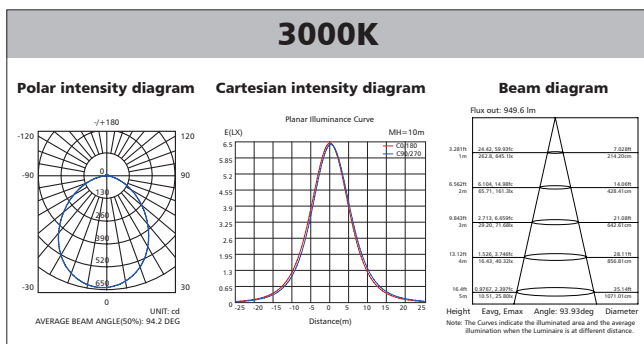

# Polar Diagram Comparison

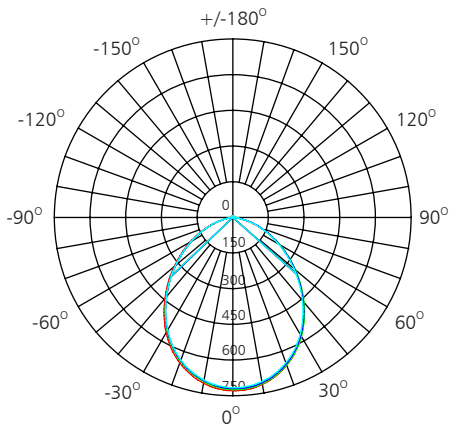

UNIT: cd

- C0/180, 94.8 deg
- C30/210, 94.7 deg
- C60/240, 94.6 deg
- C90/270, 94.6 deg



AVERAGE BEAM ANGLE (50%): 94.7DEG

# Driver lifetime & LED light decay rate

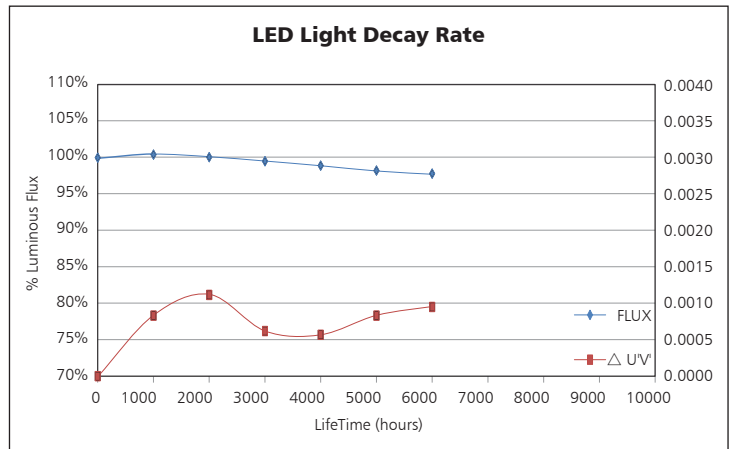
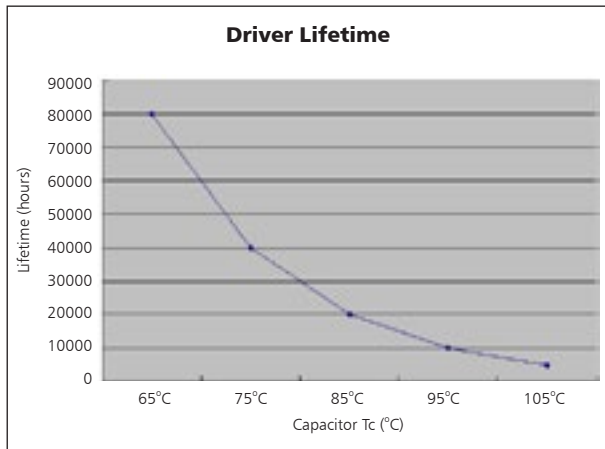

# Temperature

- The testing is operated at 25°C
- The lifetime of capacitor, minimum of 5,000 hours if operated at 105°C, will be doubled whenever the temperature drops 10°C
- The highest withstand temperature of IC, MOS could be 120°C
- The highest withstand temperature of LED junction temperature is 150°C

The driver lifespan is based on capacitor working temperature.

# Installation

Install requirements	
A-gap above the fitting	25mm
B-gap to the building material	25mm
C-gap to the thermal insulation	25mm

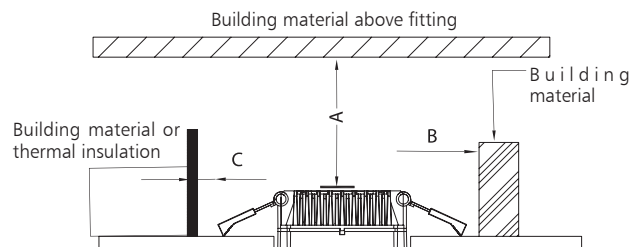

<p><b>Ceiling Opening Ø140-150mm</b></p> <p style="text-align: right;">1</p>	<p><b>Connect Power supply</b></p> <p style="text-align: right;">2</p>
<p><b>A. Hold back spring clips</b></p> <p><b>B. Push downlight into position</b></p> <p style="text-align: right;">3</p>	<p><b>Spring Clips</b></p> <p style="text-align: right;">4</p>

# Packaging Information

	SIZE(CM)	N.W/pc (KGS)	G.W.(KGS)	Q'TY(PCS)
Carton	59 x 40 x 49	0.695	25	30

	CTNS	Q'TY(PCS)	VOLUME(CBM)
20" standard container	230	6900	28
40" standard container	460	13800	56

