



Up-shine® Lighting



Technical Application  
Guide for UPSHINE  
LED Ceiling light

UP-AL08-12-25W-S

# Introduction

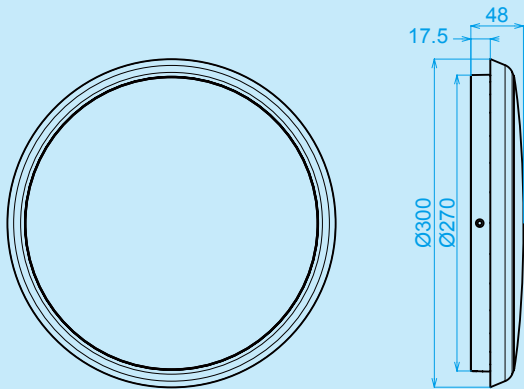

Up-shine surface mounted ceiling light adopts high lumen SMD LED, fire-rated PC diffuser with even light output. IP54 waterproof structural design, it is an ideal replacement for damp locations. driver in top branded component with triac dimmable function, 120° wide beam angle.

- Up to 70% energy saving compared to standard CFL
- Long lifetime of 40,000 hours
- Dimmable when using triac dimmer
- 120° wide beam angle
- CCT: 3000K 4000K 5000K 5700K
- No UV/IR light
- Environment friendly, without Mercury or any other hazardous substances

## Microwave sensor

### Detection area:

- ◆ 140 degree wide detective beam angle with 5~7 meters distance.

### Working pattern:

- ◆ In any given lighting condition, the light switches on automatically when presence detected.
- ◆ After presence left, light will continuously work within time-delay (30 seconds), then switch off automatically.
- ◆ After presence left, any movement detected within time-delay (30 seconds), the light will continuously work for another hold time (30 seconds), then switch off until next movement detected.
- ◆ Hold time: 30S

## Application Areas

Applicable for corridor, basement, garage, warehouse, monitoring, and other places of energy-saving indoor and outdoor lighting.



## Technical Specifications

Model	Voltage	Power	Power Factor	Lumen (±5%)	Beam angle	CCT	Lifespan	CRI	Dimmable	Dimension
UP-AL08-12-25W-S	AC230V	25W	≥0.9	2000	120°	3000K	40000h	≥80	No	Ø300*48mm
UP-AL08-12-25W-S	AC230V	25W	≥0.9	2150	120°	4000K	40000h	≥80	No	Ø300*48mm
UP-AL08-12-25W-S	AC230V	25W	≥0.9	2180	120°	5000K	40000h	≥80	No	Ø300*48mm
UP-AL08-12-25W-S	AC230V	25W	≥0.9	2120	120°	5700K	40000h	≥80	No	Ø300*48mm

## Driver data Sheet

Driver data	Sensor	Main Power
Input rated Voltage	AC230V	AC230V
Frequency	50Hz	50Hz
Input Voltage	AC200-240V	AC200-240V
Efficiency	—	≥88%
No load wattage	—	≤0.4W
Total load Wattage	2W±0.5W	25W±5%
Power Factor	—	≥0.9
Rated input current	≤0.02A	≤0.14A
Full load output Voltage	—	60-75V
Rated output current	—	320mA
Output current range	—	320mA±5%
Power tolerance	—	±5%
Current output tolerance	—	±5%
Hold time	30S	—
Detection distance	5-7m	—
Battery duration	—	—
Charge Period	—	—
Short circuit protection	—	PASS
Over voltage protection	—	PASS
Over temperature protection	—	PASS
Withstand voltage	—	AC3750V

## Fixture Compatibility

Rated Wattage	Electrical Classification	Ingress Protection	Operating Temp	Operating Humidity	Storage Temp
25W	II	IP54	-20°C~45°C	0~90%	-20°C~65°C

## Wiring Diagram:

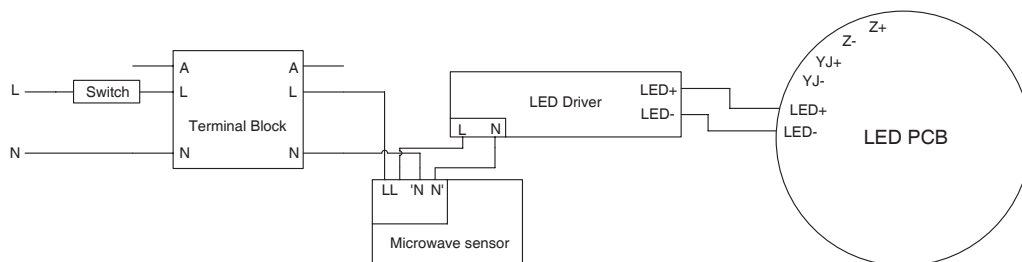

# Spectral Distribution

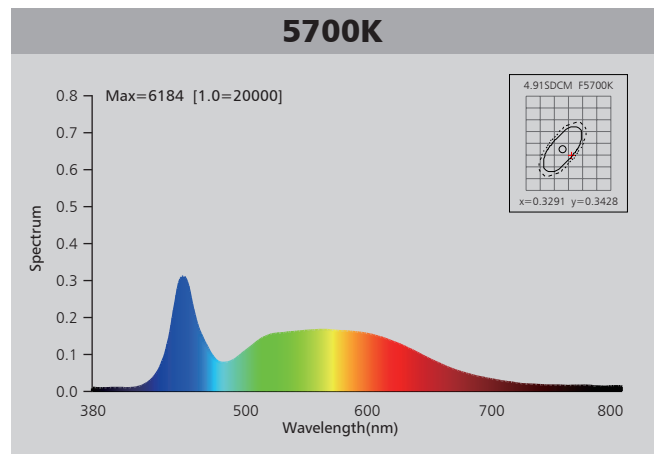
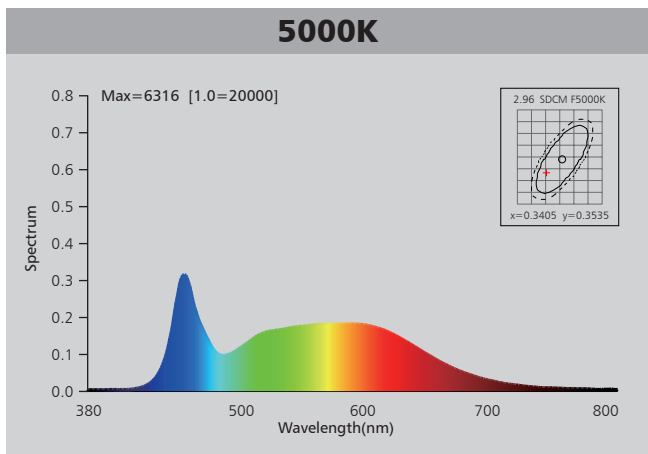
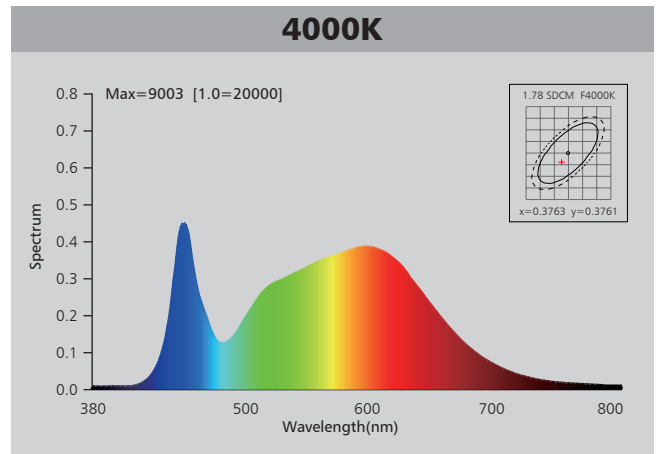
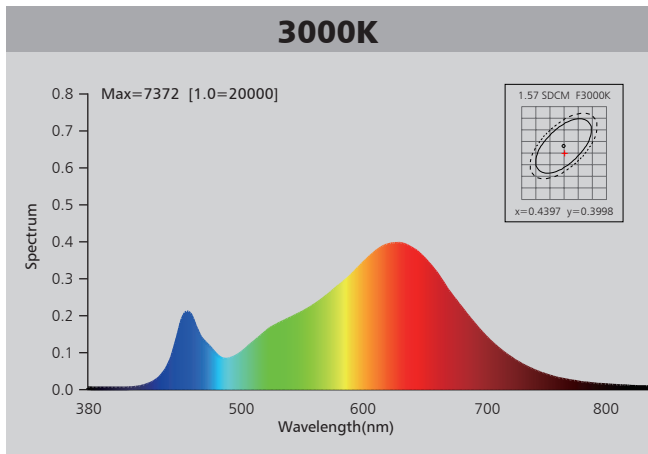

# Photometric Diagram

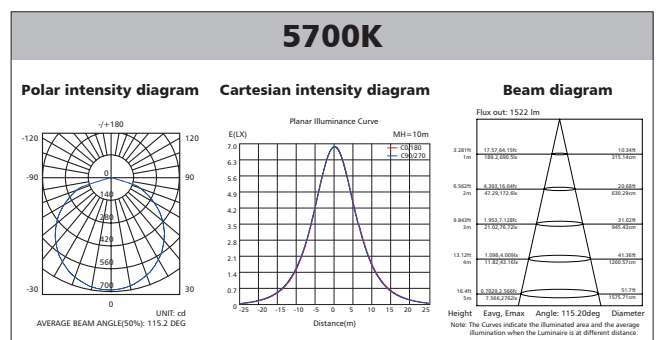
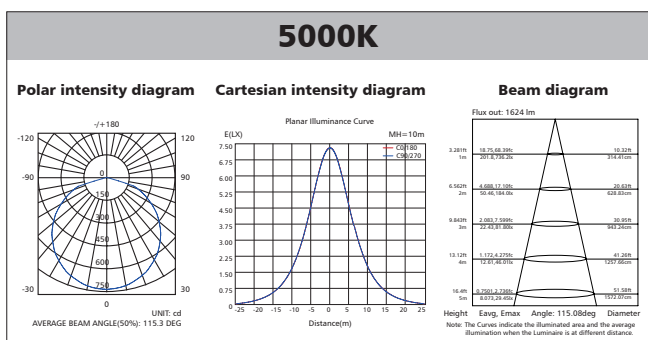
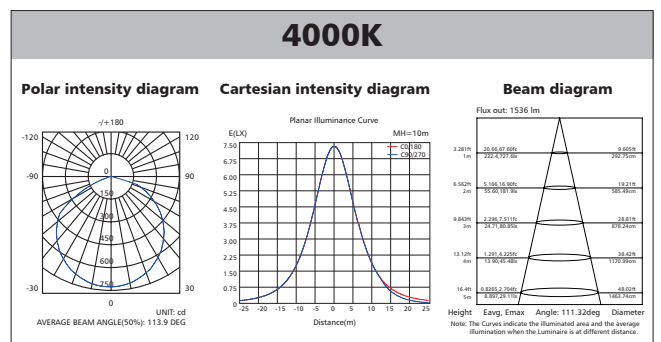
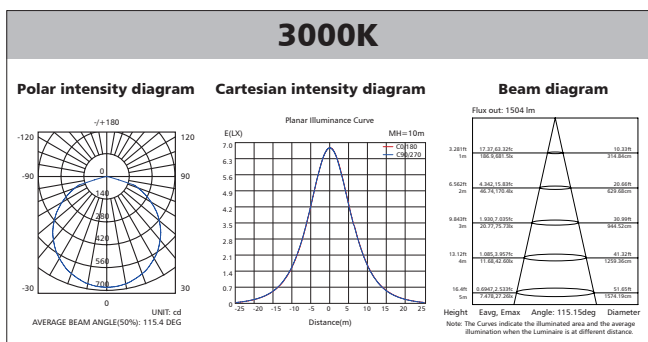

# Polar Diagram Comparison

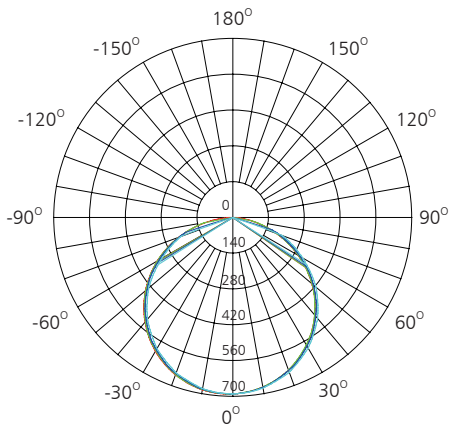

UNIT: cd

- C0/180, 115.2 deg
- C30/210, 115.2 deg
- C60/240, 115.2 deg
- C90/270, 115.1 deg



AVERAGE BEAM ANGLE (50%): 115.2 DEG

# Driver lifetime & LED light decay rate

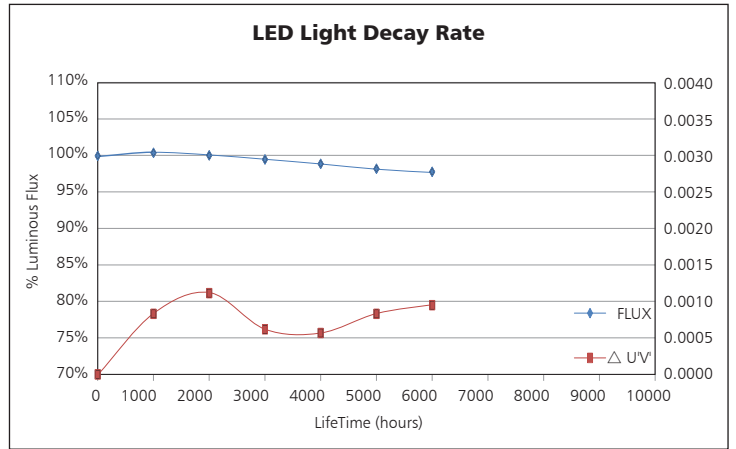
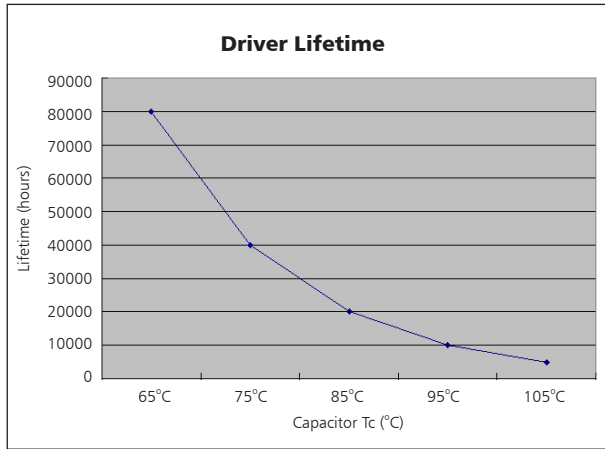

# Temperature

- The testing is operated at 25°C
- The lifetime of capacitor, minimum of 5,000 hours if operated at 105°C, will be doubled whenever the temperature drops 10°C
- The highest withstand temperature of IC, MOS could be 120°C
- The highest withstand temperature of LED junction temperature is 150°C

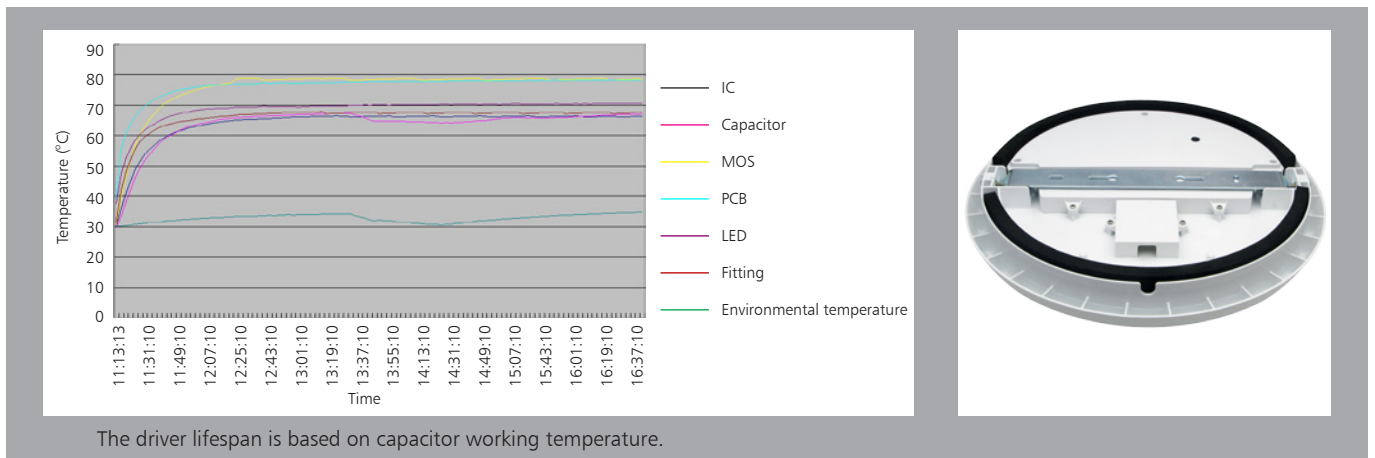

The driver lifespan is based on capacitor working temperature.



# Installation

1. Take out ceiling light and accessory pack from box

2. Knock-in the plastic anchor into ceiling

3. Remove screw, take out bracket

4. Fix bracket with screw into the ceiling

5. Open junction box, wire "L""N" to terminal block and mount ceiling light into the right place

— L = SWITCHED  
— N = NEUTRAL

6. Switch on

# Packaging Information

	SIZE(CM)	N.W/pc (KGS)	G.W.(KGS)	Q'TY(PCs)
Carton	61*32.5*33.5	1.12	12.2	10

	CTNS	Q'TY(PCs)	VOLUME(CBM)
20" standard container	410	4100	28
40" standard container	820	8200	56

