

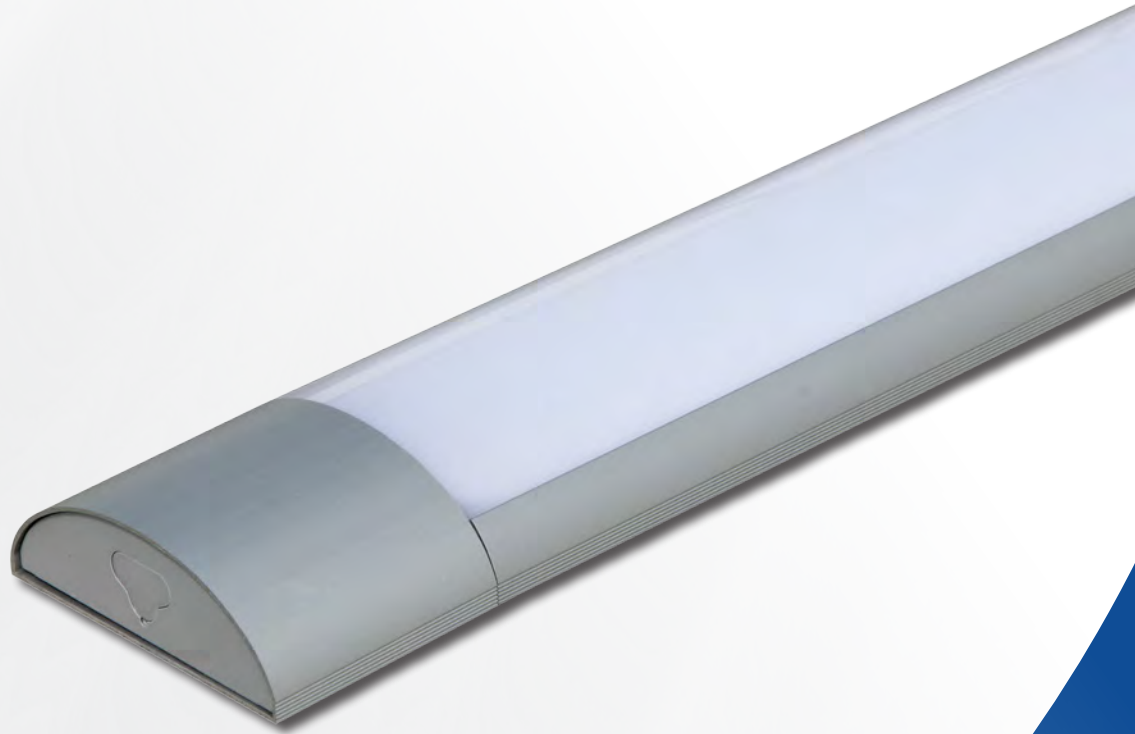

Up-shine[®] Lighting

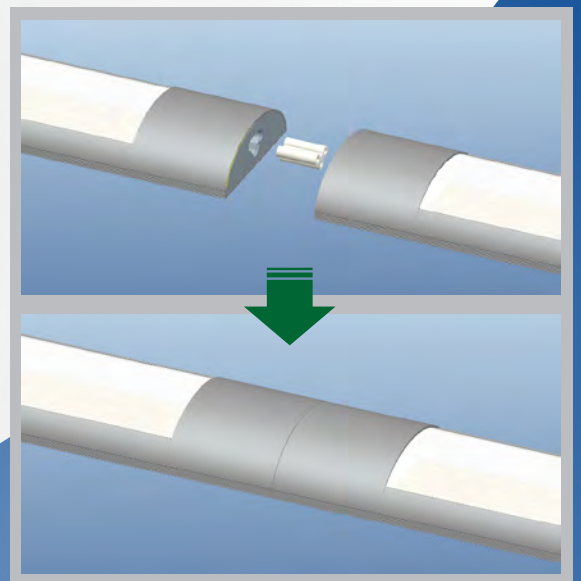

Technical Application
Guide for UP-SHINE
LED Batten
UP-DB01-32W



Introduction

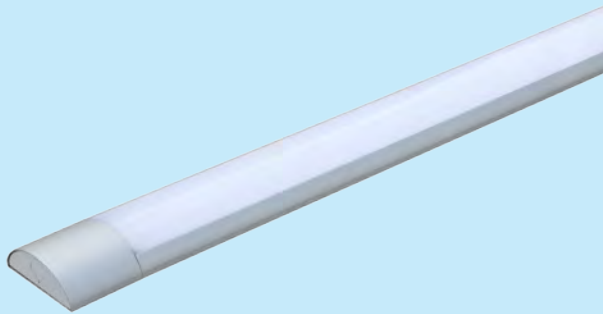

Compared with Up-shine regular batten, DB01 is a new design with zero distance & seamless connection installation. Stretching Aluminum is employed both on lamp housing and end caps, aims at maintaining color consistency of surface treatment during production. It is impressive in texture and workmanship.

As an easy replacement of traditional grille and tube, batten makes itself outstanding with fast installation and easy connection between each unit, maximally reduce electrician cost.

- Up to 70% energy saving compared to standard CFL
- Long lifetime of 40,000 hours
- 110° wide beam angle
- CCT: 3000K 4000K
5000K 5700K
- No UV/IR light
- Environment friendly, without Mercury or any other hazardous substances

Application notes

- IP20 for indoor use only
- Professional electrician for installation only
- Switch off before installation
- Do not touch when in use
- Keep away from hot steam and corrosive gas

Application Areas

it is suitable for commercial and industrial use, such as super market, garage, office building, workshop etc.

Certificate

RoHS

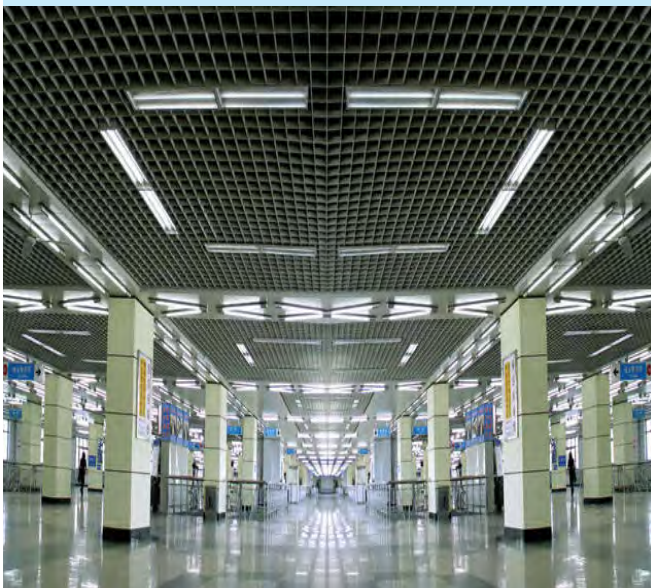

Product Information

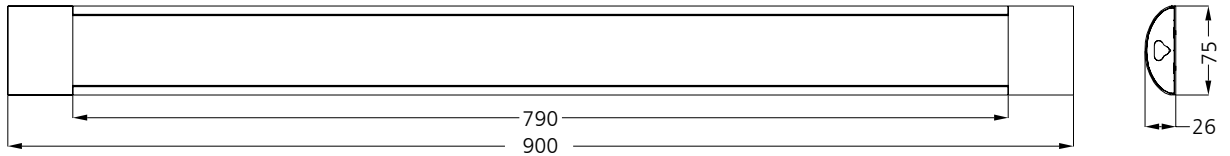

Technical Specifications

Model	Voltage	Power	Power Factor	Lumen (±5%)	Beam angle	CCT	Lifespan	CRI	Dimmable	Dimension
UP-DB01-32W	AC100-277V	32W	≥0.9	2820	110°	3000K	40000h	≥80	No	900*75*26mm
UP-DB01-32W	AC100-277V	32W	≥0.9	2910	110°	4000K	40000h	≥80	No	900*75*26mm
UP-DB01-32W	AC100-277V	32W	≥0.9	2880	110°	5000K	40000h	≥80	No	900*75*26mm
UP-DB01-32W	AC100-277V	32W	≥0.9	2720	110°	5700K	40000h	≥80	No	900*75*26mm

Driver data Sheet

Driver data	Non-dim
Input rated Voltage	AC100-277V
Frequency	50/60Hz
Input Voltage	AC90-305V
Efficiency	≥88%
Total load Wattage	2*16W±5%
Power Factor	≥0.9
Rated input current	≤2*0.18A
Full load output Voltage	DC64-72V
Rated output current	2*220mA
Output current range	2*220mA±5%
Power tolerance	±5%
Current output tolerance	±5%
Short circuit protection	PASS
Over voltage protection	PASS
Over temperature protection	PASS
THD	≤30%
Withstand voltage	AC1500V

Fixture Compatibility

Rated Wattage	Electrical Classification	Ingress Protection	Operating Temp	Operating Humidity	Storage Temp
32W	I	IP20	-20°C~45°C	0~90%	-20°C~65°C

Spectral Distribution

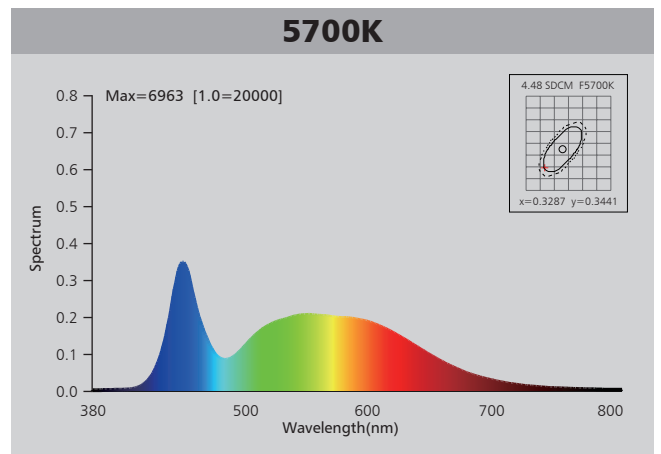
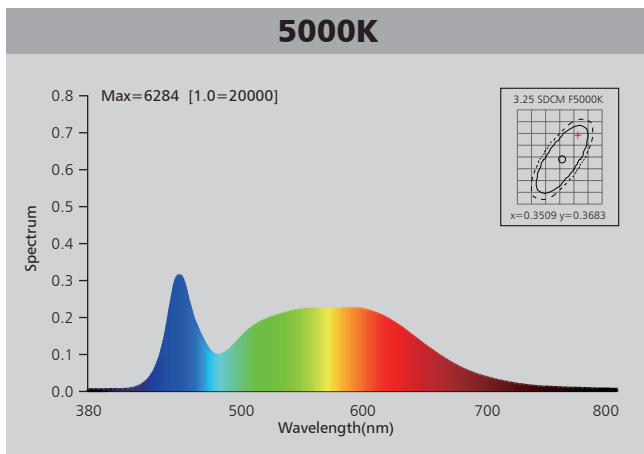
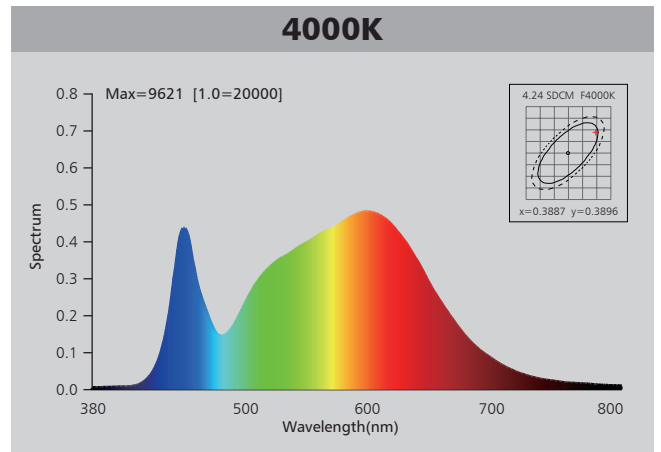
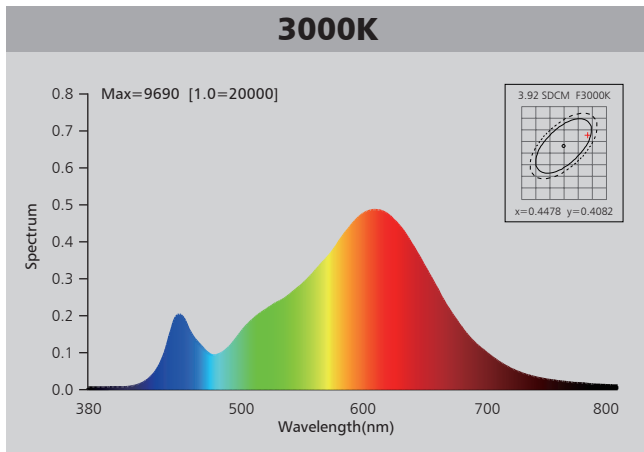

Photometric Diagram

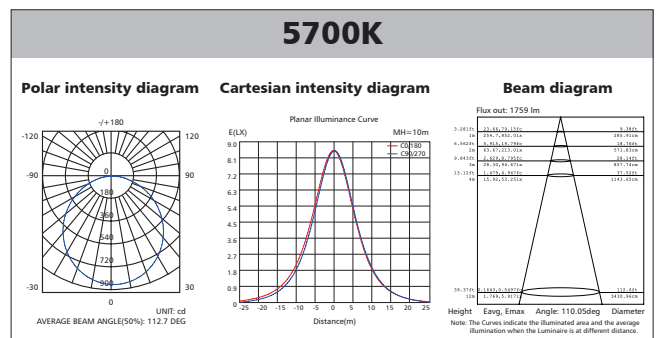
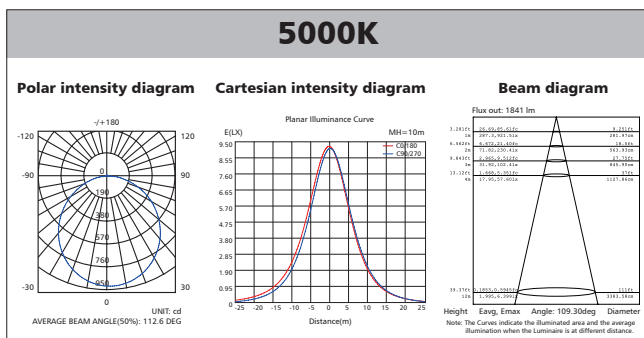
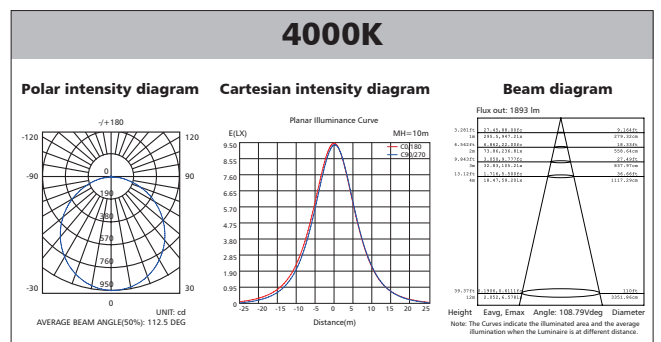
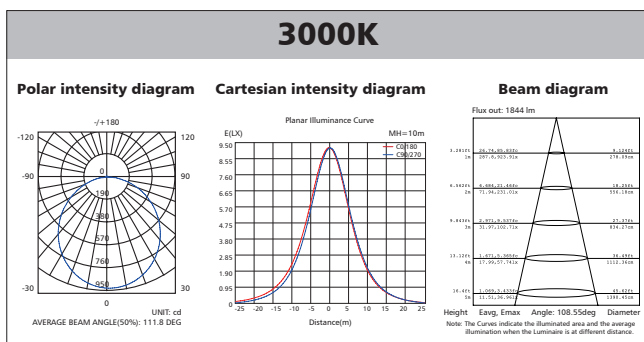

Polar Diagram Comparison

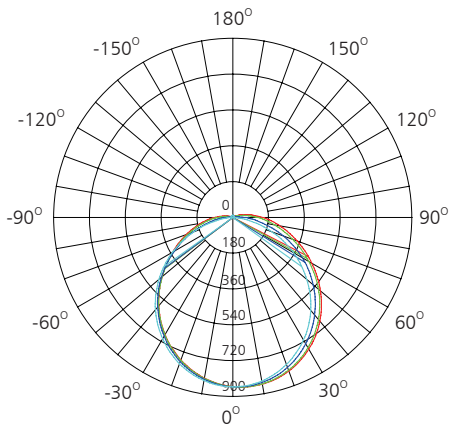

UNIT: cd

- C0/180, 115.9 deg
- C30/210, 114.3 deg
- C60/240, 111.6 deg
- C90/270, 109.2 deg

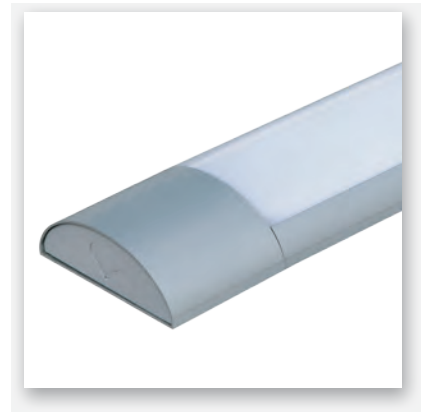

AVERAGE BEAM ANGLE (50%): 112.7DEG

Driver lifetime & LED light decay rate

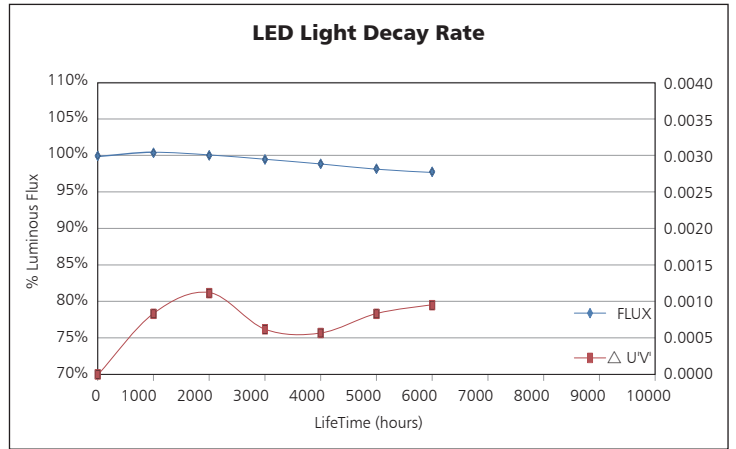
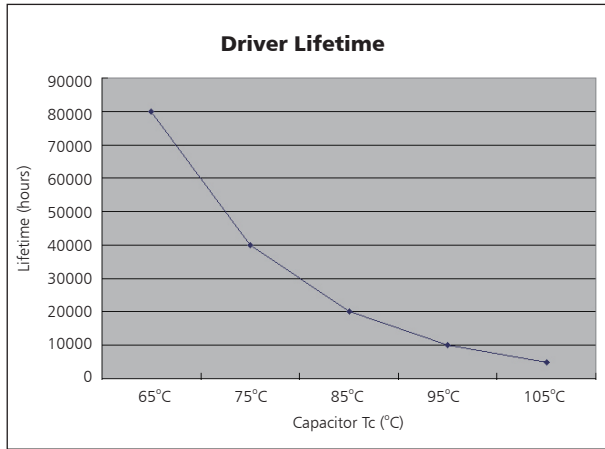

Temperature

- The testing is operated at 25°C
- The lifetime of capacitor, minimum of 5,000 hours if operated at 105°C, will be doubled whenever the temperature drops 10°C
- The highest withstand temperature of IC, MOS could be 120°C
- The highest withstand temperature of LED junction temperature is 150°C

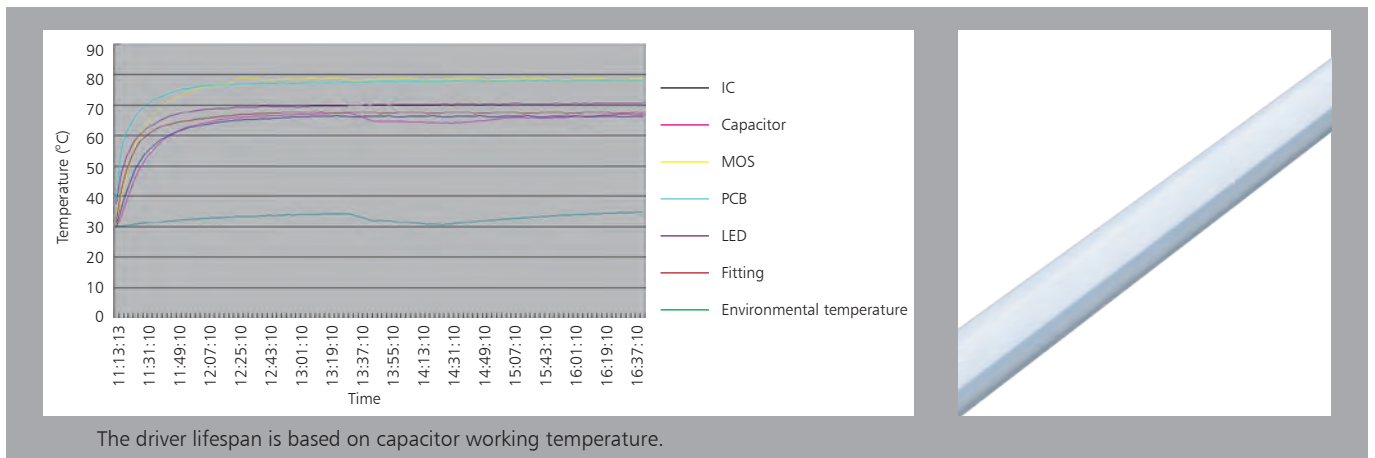

The driver lifespan is based on capacitor working temperature.

Installation

Step 1. Knock-in the plastic anchor into ceiling

Step 2. Fastening the clips on the ceiling

Step 3. Connect the power supply and hang the fixture back to the clips

Step 4. Restore power supply, switch on and test for correct operation

L = SWITCHED
 Ⓧ = EARTH
 N = NEUTRAL

1+1+1+1.....N ≤ 240W

Packaging Information

	SIZE(CM)	N.W/pc (KGS)	G.W.(KGS)	Q'TY(PCs)
Carton	95*46*22.5	0.6	20	25

	CTNS	Q'TY(PCs)	VOLUME(CBM)
20" standard container	280	7000	28
40" standard container	560	14000	56

