

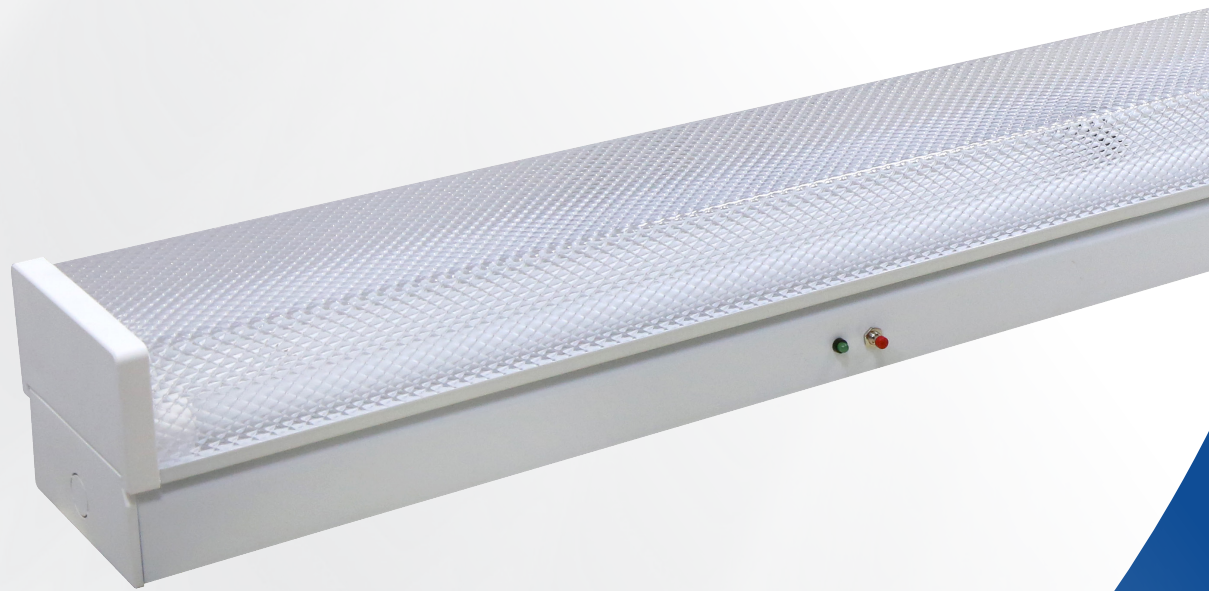

Up-shine[®] Lighting



Technical Application
Guide for UP SHINE
LED T8 Batten
UP-AL06-50W-BT-M

Introduction

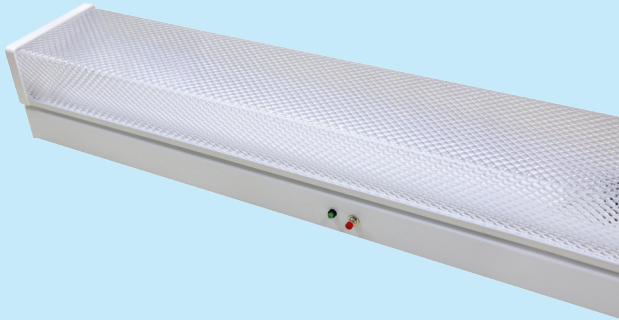

T8 diffused batten suitable for ceiling, wall or pendant mounting. Prismatic diffuser for visual comfort. Cover plate held securely by threaded nut for fast installation. High quality white epoxy powder coated finish. Large terminal block for ease in installation. New plastic snap-on end caps for easy installation of diffuser. Emergency&sensor multi-function provided for wide choice.

- Up to 70% energy saving compared to standard CFL
- Long lifetime of 40,000 hours
- 120° wide beam angle
- CCT: 3000K 4000K
5000K 5700K
- No UV/IR light
- Environment friendly, without Mercury or any other hazardous substances

Application notes

- IP20 for indoor use only
- Professional electrician for installation only
- Switch off before installation
- Do not touch when in use
- Keep away from hot steam and corrosive gas

Application Areas

All commercial, industrial and domestic applications

Certificate

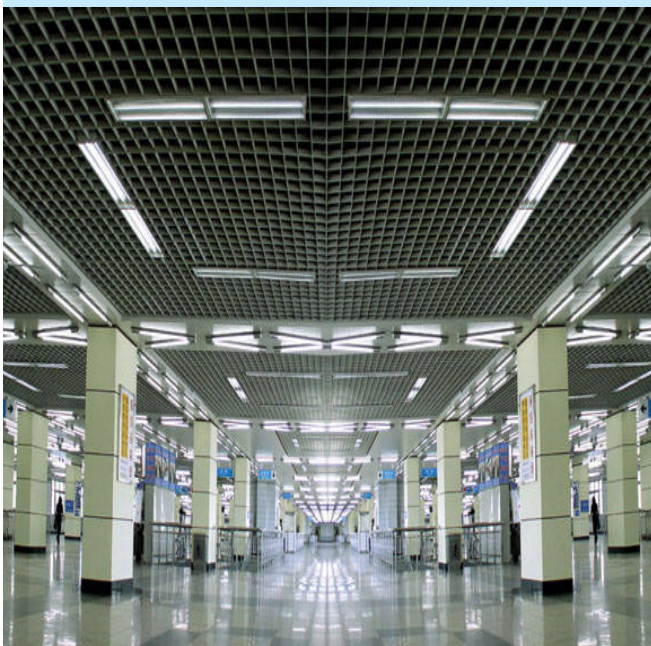

Sensor Setting

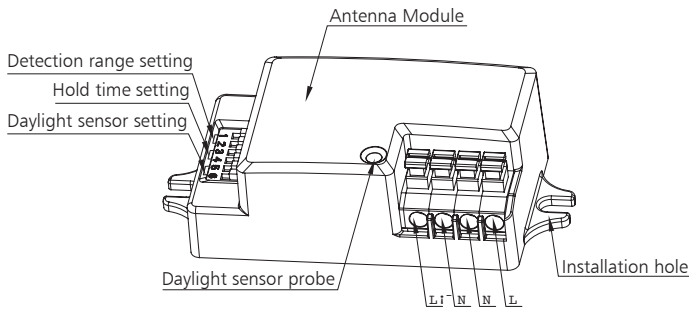

UC01	
Operating voltage	220~240Vac, 50Hz
Rated load	400W(inductive), 800W(resistive)
HF system	5.8GHz±75MHz, ISM wave band
Transmitting power	<0.2mW
Power consumption	≤0.5W(standby)
Detection zone	Max.(D×H): 10m×6m
Detection sensitivity	10% / 50% / 75% / 100%
Hold time	5s / 90s / 5min / 15min
Daylight sensor	2lux / 10lux / 50lux / Disable
Mounting height	6m Max.
Motion detection	0.5~3m/s
Detection angle	30°-150°
Operating temperature	-20 ~60
IP rating	IP20

By selecting the combination on the DIP switch, sensor data can be precisely set for each specific application.

	1	2	
I	●	●	100%
II	●	○	75%
III	○	●	50%
IV	○	○	10%

Detection area

Detection area can be set by selecting the combination on the switches to fit precisely each application.

	3	4	
I	●	●	5s
II	●	○	90s
III	○	●	5min
IV	○	○	15min

Hold time

Refers to the time period the lamp remains at 100% illumination after no motion detected.

5S for testing purpose only please do not choose 5S for daily use.

	5	6	
I	●	●	Disable
II	●	○	50Lux
III	○	●	10Lux
IV	○	○	2Lux

Daylight sensor

The sensor can be set to only allow the lamp to illuminate below a defined ambient brightness threshold.

When set to Disable mode, the daylight sensor will switch on the lamp when motion is detected regardless of ambient light level.

50lux: twilight operation, 10lux, 2lux: darkness operation only.

Detection Pattern

Ceiling Mounting pattern (Unit: m)

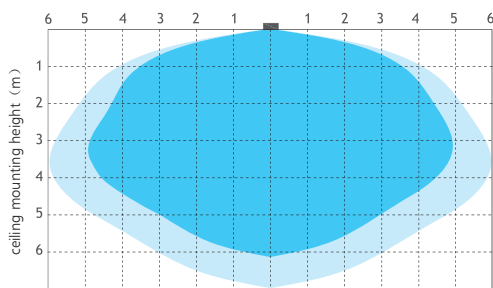

■ High detection area ■ Low detection area

Wall Mounting pattern (Unit: m)

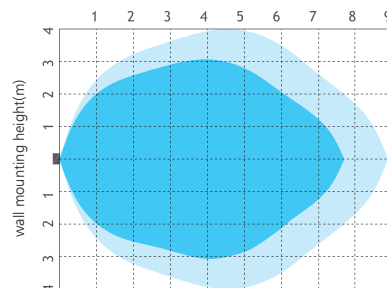

■ High detection area ■ Low detection area

Product Information

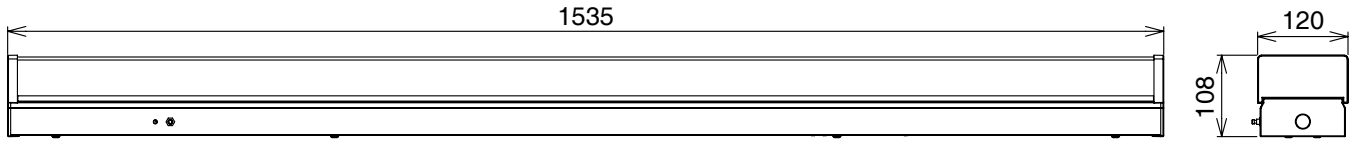

Technical Specifications

Model	Voltage	Power	Power Factor	Lumen (±5%)	Beam angle	CCT	Lifespan	CRI	Dimmable	Dimension
UP-AL06-50W-BT-M	AC230V	50W	≥0.9	4150	120°	3000K	40000h	≥80	No	1535*120*108mm
UP-AL06-50W-BT-M	AC230V	50W	≥0.9	4250	120°	4000K	40000h	≥80	No	1535*120*108mm
UP-AL06-50W-BT-M	AC230V	50W	≥0.9	4300	120°	5000K	40000h	≥80	No	1535*120*108mm
UP-AL06-50W-BT-M	AC230V	50W	≥0.9	4250	120°	5700K	40000h	≥80	No	1535*120*108mm

Driver data Sheet

Driver data	Emergency	Main Power
Input rated Voltage	AC230V	AC230V
Frequency	50Hz	50Hz
Input Voltage	AC220-240V	AC220-240V
Efficiency	≥80%	≥89%
Total load Wattage	3-4W	50W±5%
Power Factor	—	≥0.9
Rated input current	≤0.04A	≤0.28A
Full load output Voltage	DC24-38V	60-75V
Rated output current	100-170mA	640mA
Output current range	—	640mA±5%
Power tolerance	3-4W±0.5W	±5%
Current output tolerance	—	±5%
Battery	7.2v 26000mAh	—
Lifetime	30000hrs	—
Battery duration	≥ 3hrs	—
Charge time	≥ 24hrs	—
Emergency switching time	≅ 1S	—
Short circuit protection	—	PASS
Over voltage protection	—	PASS
Over temperature protection	PASS	PASS
Withstand voltage	AC1500V	AC1500V

Fixture Compatibility

Rated Wattage	Electrical Classification	Ingress Protection	Operating Temp	Operating Humidity	Storage Temp
50W	I	IP20	-20°C~45°C	0~90%	-20°C~65°C

Spectral Distribution

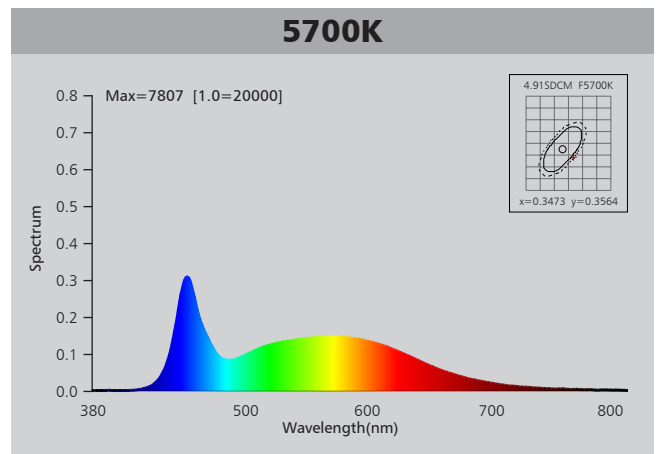
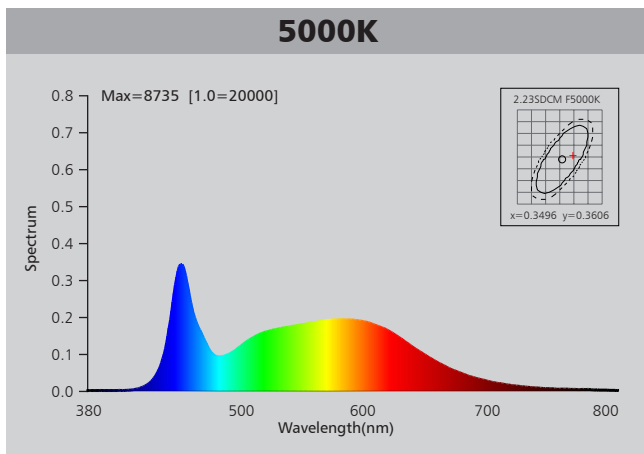
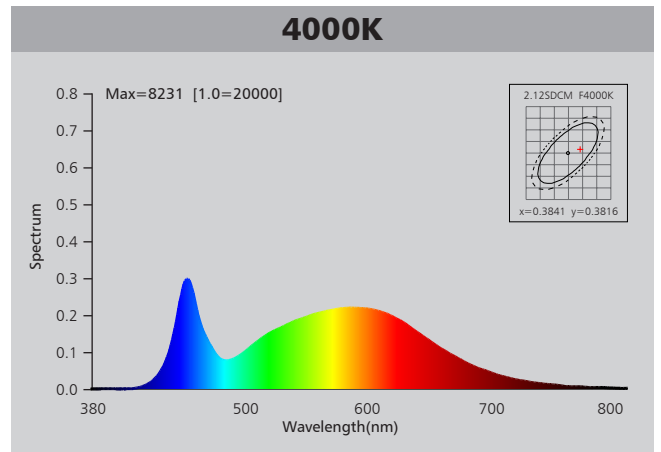
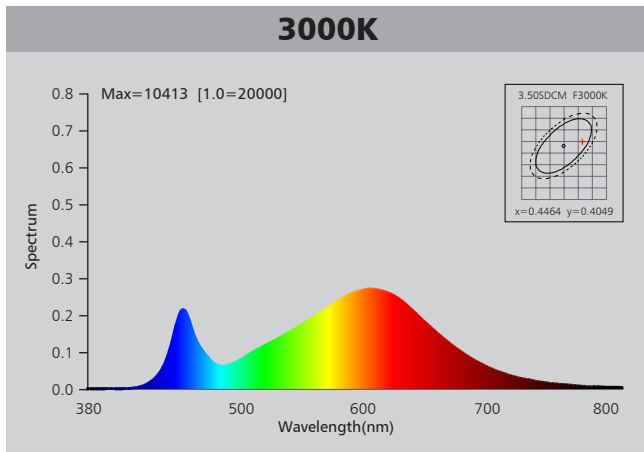

Photometric Diagram

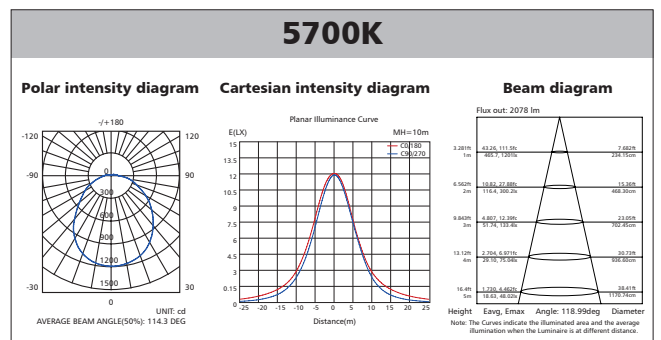
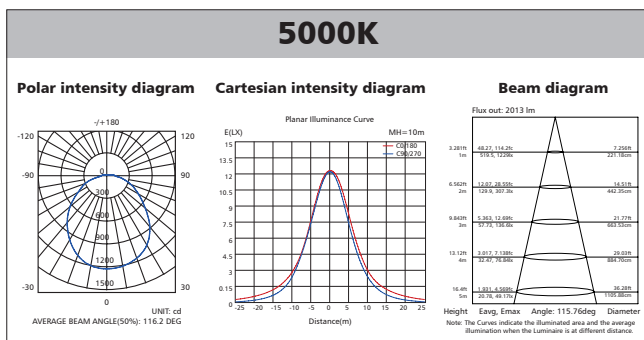
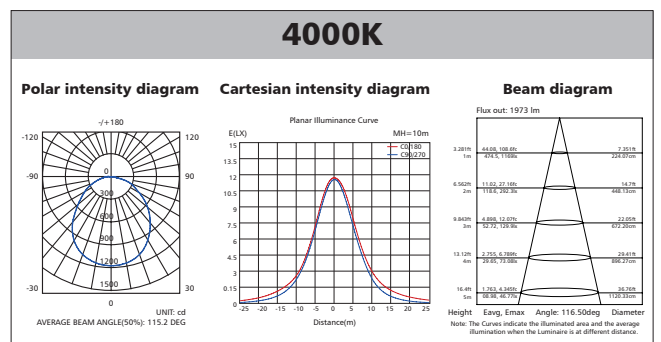
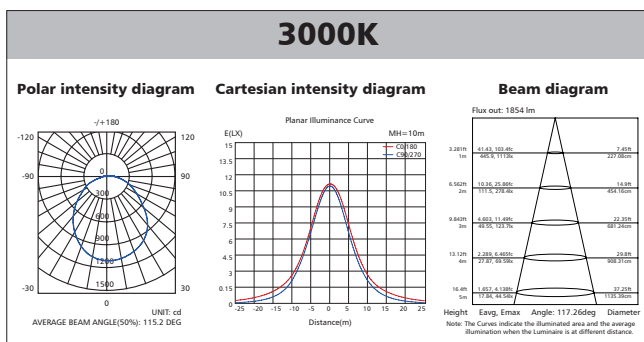

Polar Diagram Comparison

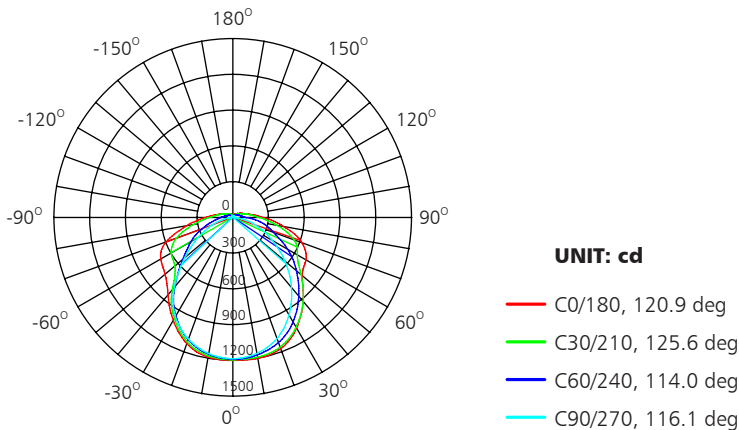

AVERAGE BEAM ANGLE (50%): 116.6DEG

Driver lifetime & LED light decay rate

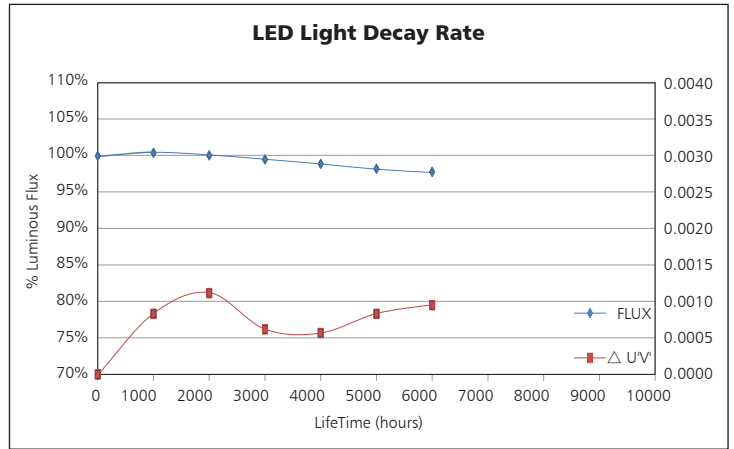
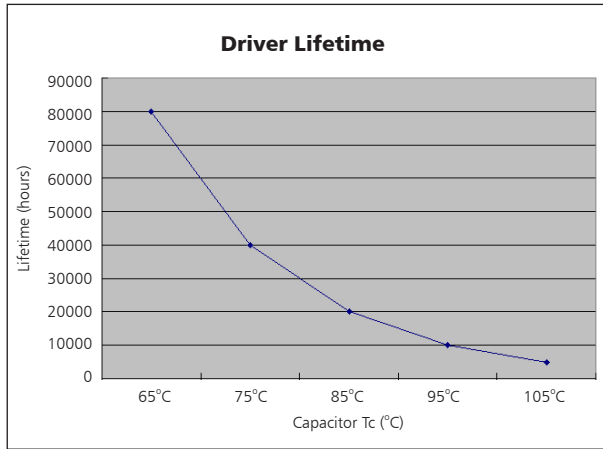

Temperature

- The testing is operated at 25°C
- The lifetime of capacitor, minimum of 5,000 hours if operated at 105°C, will be doubled whenever the temperature drops 10°C
- The highest withstand temperature of IC, MOS could be 120°C
- The highest withstand temperature of LED junction temperature is 150°C

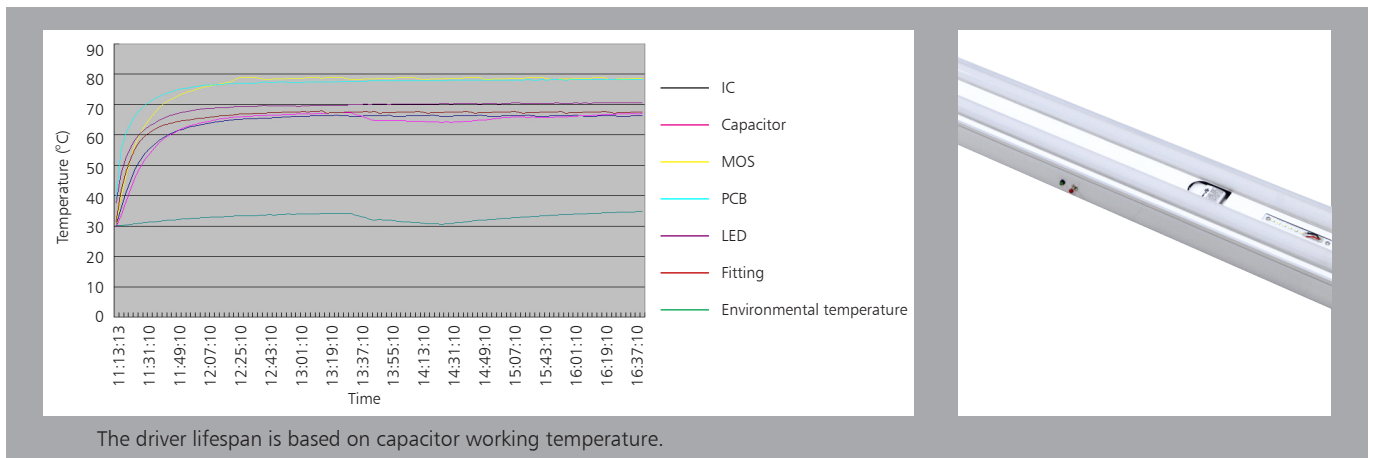

Installation

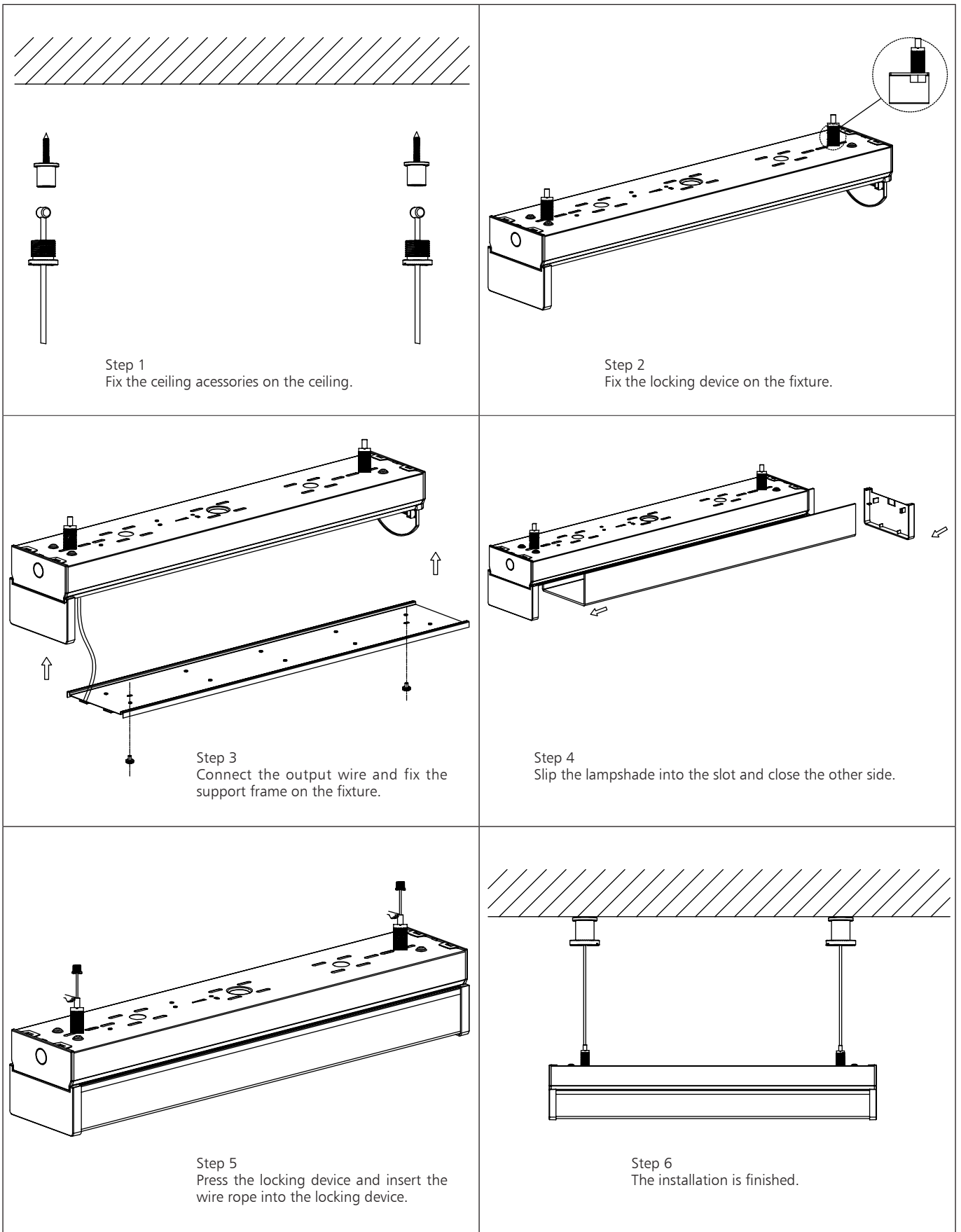

Installation

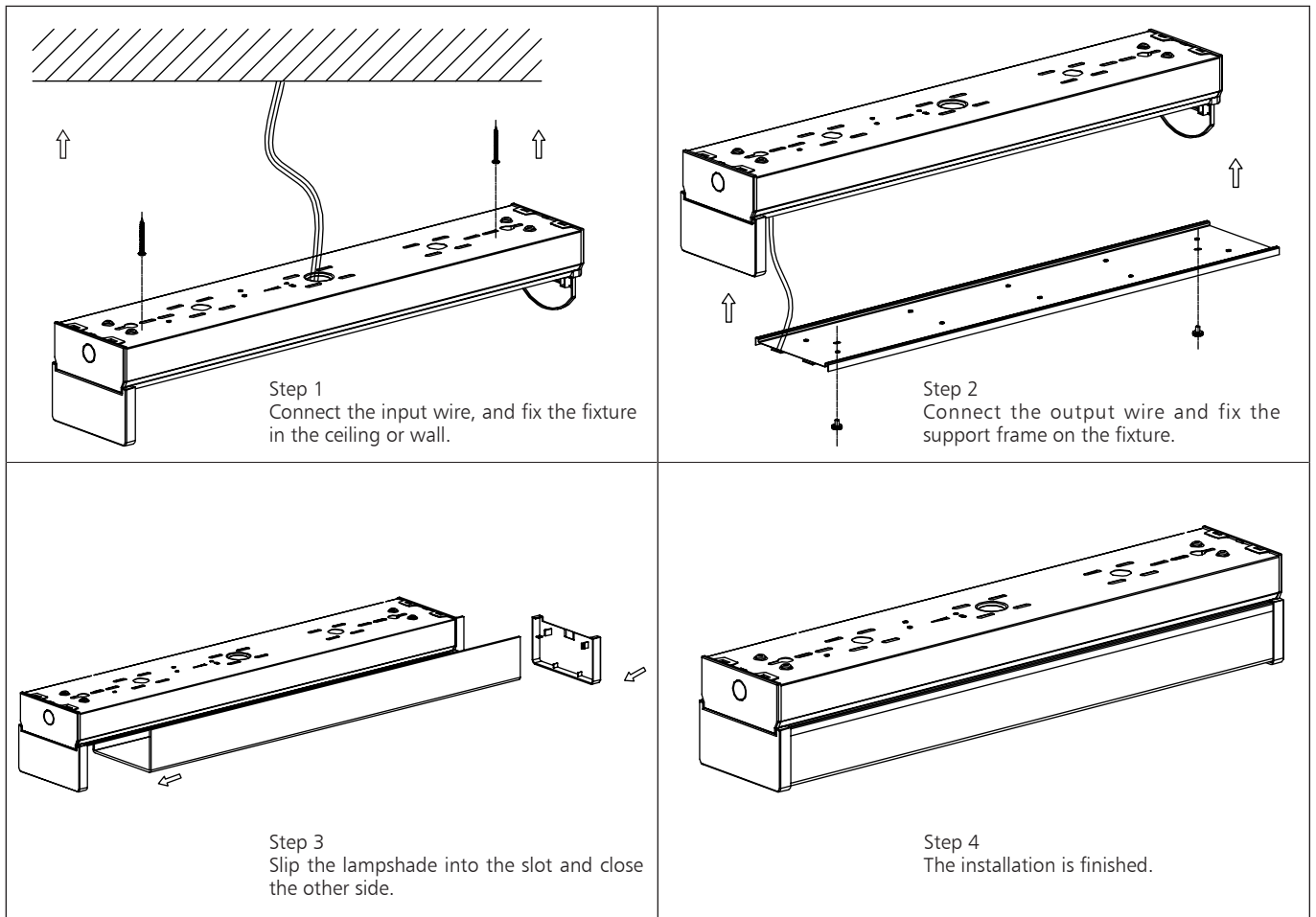

Packaging Information

	SIZE(CM)	N.W/pc (KGS)	G.W.(KGS)	Q'TY(PCS)
Carton	156*27.5*26	4.8	21	4

	CTNS	Q'TY(PCS)	VOLUME(CBM)
20" standard container	230	920	28
40" standard container	460	1840	56

